

|             |  |           |  |      |  |
|-------------|--|-----------|--|------|--|
| Project     |  | Catalog # |  | Type |  |
| Prepared by |  | Notes     |  | Date |  |

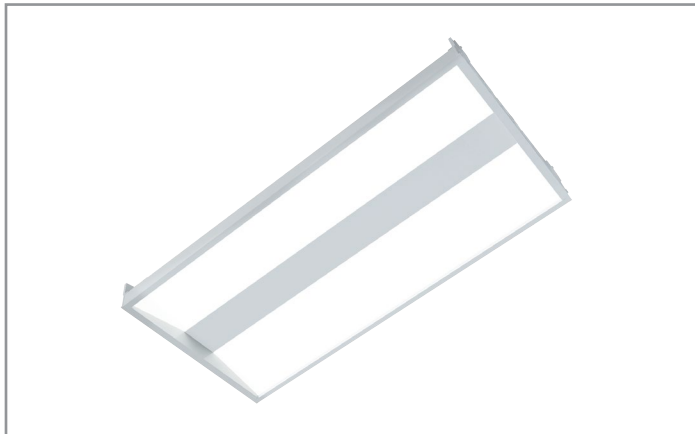

# Metalux

## Encounter 12EN LED

1' x 2' Troffer LED Module  
Specification Grade Troffer

### Typical Applications

- Commercial Office Spaces • Schools • Hospitals • Retail
- Other Indoor Ambient Applications

### Product Certification



### Product Features



### Interactive Menu

- Order Information [page 2](#)
- Photometric Data [page 3](#)
- Control Solutions [page 4](#)
- Connected Systems [page 4](#)
- Product Warranty

### Top Product Features

- Available in 1' x 2', 1' x 4', 2' x 2' and 2' x 4' recessed versions
- Leverages our patented WaveStream Technology with AccuAim™ optics
- Four CCT options: 3000K, 3500K, 4000K, and 5000K at 80CRI or 90 CRI
- White tuning solutions available, either 3000K - 5000K or 2700K - 6500K
- Efficacy up to 143 lumens per watt

### Dimensional and Mounting Details

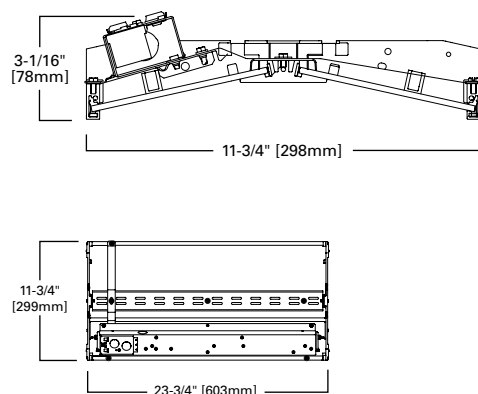

### Ceiling Compatibility

| G<br>Grid/Lay-in<br>Standard | G or T<br>9/16" or 15/16"<br>Slot Grid | F<br>Drywall Frame<br>Kit | Ceiling<br>Type | Trim<br>Type |
|------------------------------|--|---------------------------|-----------------|--------------|
|                              |  |                           | Exposed Grid    | G            |
|                              |  |                           | Concealed T     | G or T       |
|                              |  |                           | Slot Grid       | G or T       |
|                              |  |                           | Flange          | *            |

**Notes:**  
 \*See Drywall Frame Kit Accessory in Ordering Information section.  
 \*\*Fixture construction is suitable for use in Air-handling and plenum rated spaces in accordance with Section 300.22 (C) of the National Electrical Code, Section 4.3.11.2.6.5 of NFPA 90A and Section 602.2.1.4 of ICC.

## Order Information

SAMPLE ORDER NUMBER: **12EN-LD2-13-UNV-L835-CD1-SVPD1-U**

| Rating   | Series                                      | Air  | Lamp Type           | MTO Lumen Output  | Voltage  | Emergency Options   |
|--|---|--|---------------------|---|--|---|
| <b>[Blank]</b> =Standard<br><b>ATW-SW4</b> =<br>Chicago Rated <sup>(5)</sup> | <b>12EN</b> =1' x 2'<br>Encounter<br>Series | <b>[Blank]</b> =Standard<br><b>A=Air</b> (Vented) <sup>(6)</sup>   | <b>LD2</b> =LED 2.0 | <b>08</b> =800 Lumens <sup>(8)</sup><br><b>13</b> =1300 Lumens <sup>(8)</sup><br><b>17</b> =1700 Lumens<br><b>23</b> =2300 Lumens<br><b>27</b> =2700 Lumens<br><b>31</b> =3100 Lumens<br><b>35</b> =3500 Lumens<br><b>39</b> =3900 Lumens | <b>UNV</b> =Universal Voltage<br>120-277<br><b>347V</b> =347 Volt <sup>(4)</sup><br><b>48V</b> =48 Volt Low-voltage<br>(Class 2) <sup>(c)</sup>  | <b>EL7W</b> =7-watt, 120V-277V emergency battery pack installed <sup>(2)</sup><br><b>ELV7W</b> =7-watt, DLVP-compatible low voltage emergency battery pack installed <sup>(c)</sup><br><b>GTR2</b> =Generator Transfer Relay <sup>(7)</sup><br><b>ETRD</b> =Emergency Transfer Relay with dimming control <sup>(7)</sup>  |
| <b>Notes</b><br>(5) Chicago rated version does not allow for row mounting.   |   | <b>Notes</b><br>(6) Air version is vented but does not meet air handling requirements; a 6% reduction in delivered lumens is experienced with this option. |                     | <b>Notes</b><br>(8) White tuning not available with 800 and 1300 lumen options.   | <b>Notes</b><br>(1) Products also available in non-US voltages and frequencies for international markets.<br>(4) 347V emergency option not available.<br>(c) Consult DLVP system pages for additional details and compatibility. | <b>Notes</b><br>(2) With integral test switch/indicator/laser test. For approximate delivered lumens multiply the lumens per watt of the desired fixture by the wattage of the emergency battery pack (100 lm/W x 7=700 lumens). IES-format photometry for luminaire under emergency operation available. (7) Used to bypass local control during outage. Must be used in conjunction with UL 1008 device (provided by others). GTR2 option includes 2 relays on fixtures with dimming drivers. ETRD option only requires one relay when used on a dimming fixture. (c) Consult DLVP system pages for additional details and compatibility. |

| CCT  | Flex   | Driver Type  | Number of Drivers |
|--|--|--|-------------------|
| <b>L830</b> =3000K<br><b>L835</b> =3500K<br><b>L840</b> =4000K<br><b>L850</b> =5000K<br><b>L83050</b> =80CRI 3000K-5000K White Tuning <sup>(9)</sup><br><b>L93050</b> =90CRI 3000K-5000K White Tuning <sup>(9)</sup><br><b>L82765</b> =80CRI 2700K-6500K White Tuning <sup>(9)</sup><br><b>L92765</b> =90CRI 2700K-6500K White Tuning <sup>(9)</sup> | <b>A3/8-4/18GDIM</b> =3/8" Flex with 0-10V Dimming Leads<br>Multiple other configurations available. See below for details.<br><b>A3/8-5/18GDIM</b> =Flex with 0-10V Dimming leads and Blue for alternate wiring. See below for details.   | <b>CD</b> =0-10V Dimming Driver (1%-100% Dimming)<br><b>SR</b> =Sensor-ready Dimming Driver for LWIPD1 option (5%-100% Dimming) <sup>(8)</sup><br><b>SLTD</b> =Fifth Light DALI Driver (10%-100% Dimming) <sup>(5), (6)</sup><br><b>SLTHD</b> =Fifth Light Dimming Driver (1%-100% Dimming) <sup>(6)</sup><br><b>LV1</b> =DLVP Dimming Driver (0%-100% Dimming) <sup>(c)</sup><br><b>SD</b> =Step Dimming Driver (50% or 100% Dimming) <sup>(8)</sup><br><b>LH</b> =Lutron HiLume (LDE1 series) 1%-100% EcoSystem Driver with Soft-on Fade to Black dimming <sup>(7)</sup><br><b>L5</b> =Lutron 5 Series (LDE5-Series) 5%-100% EcoSystem Driver <sup>(f)</sup><br><b>W2A</b> =White Tuning, 2ch, Intensity and CCT Control <sup>(9)</sup>  | <b>1=1 Driver</b> |
| <b>Notes</b><br>(9) White tuning provides correlated color temperatures (CCT) between 3000K (warm) to 5000K (cool) or 2700K (warm) to 6500K (cool). Must be used in conjunction with W2A driver only. Must be used with two (2) 10V dimming control channels, 1 color, 1 intensity.  | <b>Flexible Metal Conduit Options</b><br>Flex options available for 0-10V dimming control, DALI dimming control, emergency and night light functions. 72-inch factory-installed and pre-wired to driver, fitted to luminaire housing access plate with 90° enclosed FMC connector. Not all options may be combined and installation ratings vary by type.<br><b>A3/8-4/18GDIM series notes:</b> Factory installed dimming option 3/8" flexible metal conduit with 2-#18 power and ground wires and 2-#18 UL-listed jacketed 0-10V +/- control wires. Meets UL 66, 83, 1479, 1569, 1581, 2556, NEC® 250.118, 300.22(C), 392, 396, 330, 501, 502, 503, 530, 504, 505, 518, 520, 530, 645, 72; Federal Specification A-A-59544 (formerly J-C-30B); all applicable OSHA and HUD Requirements. UL Classified 1-, 2-, and 3-hour through penetration with applicable fire stop product (not included). May be surface mounted, fished and/or embedded in plaster. Cable tray and approved raceway rated, install per NEC®; Environmental Air-Handling Space Installation per NEC® 300.22(C). | <b>Notes</b><br>(3) 800, 1300, 1700, 2300, 2700 and 3100 lumen packages not available with Step-dim or 5LTD option. (9) White tuning provides correlated color temperatures (CCT) between 3000K (warm) to 5000K (cool) or 2700K (warm) to 6500K (cool). Must be used in conjunction with W2A driver only. Must be used with two (2) 10V dimming control channels, 1 color, 1 intensity.<br>Integrated options must be used in conjunction with the associated system and may not be compatible with other options or accessories. Please refer to the following: (B) Consult Enlighted system pages for additional details and compatibility. (C) Consult DLVP system pages for additional details and compatibility. (E) Consult Fifth Light system pages for additional details and compatibility. (F) Consult Marketplace Options - Lutron system pages for additional details and compatibility. Compatible only with driver series shown, and may require two or more drivers. Requires field commissioning to operate or dim. Contact Lutron at <a href="http://www.lutron.com">www.lutron.com</a> . |                   |

| Integrated Sensing Systems  | Packaging   | Accessories   |
|---|---|---|
| <b>SWPD1</b> =WaveLinX Wireless Integrated Sensor <sup>(A), (10)</sup><br><b>LWIPD1</b> =Enlighted Wireless Integrated Sensor <sup>(B), (10)</sup><br><b>LWTPD1</b> =Enlighted Wireless Tile-mount Sensor <sup>(B), (10)</sup><br><b>SLVPD1</b> =DLVP Low-voltage Integrated Sensor <sup>(C), (10)</sup><br><b>SVPD1</b> =0-10V Stand-alone Integrated Sensor <sup>(D), (10)</sup>  | <b>U</b> =Unit Pack<br><b>PALC</b> =Job Pack, in carton | <b>T3A END E.Q. BRACKET PARTS BAG</b> (Standard with fixture)<br><b>DF-12-W</b> =1' x 2' Drywall Frame Kit<br><b>ISHH-01</b> =Programming Remote for Integrated Sensor <sup>(8)</sup><br><b>ISHH-02</b> =Personal Control Remote for Integrated Sensor <sup>(8)</sup> |
| <b>Notes</b><br>(10) Sensors are not available with the W2A driver. Vivid Tune is not DLC Qualified.<br>Integrated options must be used in conjunction with the associated system and may not be compatible with other options or accessories. Please refer to the following: (A) Consult WaveLinX system pages for additional details and compatibility. (B) Consult Enlighted system pages for additional details and compatibility. (C) Consult DLVP system pages for additional details and compatibility. (D) Consult SVPD series system pages for additional details and compatibility. |   | <b>Notes</b><br>Integrated options must be used in conjunction with the associated system and may not be compatible with other options or accessories. Please refer to the following: (D) Consult SVPD series system pages for additional details and compatibility.  |

## Product Specifications

### Construction

- Shallow 3-1/16" deep housing extruded aluminum frame
- Injected molded composite end plates
- End plates screws for strength, rigidity and gap eliminations
- End plates accessory grid-lock feature adds safety
- Four auxiliary fixture end suspension points
- Large access plate for supply connection

### Controls

- 0-10V dimming drivers to 1% standard
- WaveLinX sensor compatible for IoT capability
- Enlighted sensor compatible for IoT capability
- SVPD sensor compatible for out-of-the-box functionality
- DLVP sensor and driver compatible for low-voltage applications
- Fifth Light DALI driver, step-dimming and 3rd party drivers available

### Electrical

- LED's available in 3000K, 3500K, or 4000K at 80 CRI or 90 CRI minimum
- TM21 life at 60,000 hours up to L92 and calculated L70 exceeds 130,000 hrs.
- Drivers available in 120-277V and 347V
- White Tuning options available with Cooper Lighting's VividTune

### Emergency Battery Pack Options

- Optional 120V-277V integral emergency battery pack available in 7W or 14W
- 90-minute backup period for code compliance
- Test switch with laser pointer allows safe testing from floor
- Patented EZ Key prevents accidental discharge during construction

### Driver Access

- Drivers can be accessed via plenum

### Finish

- High reflectance baked matte white enamel finish

### Optics

- Precision formed optical assembly
- Positively retained high optical grade acrylic lenses
- WaveStream technology provides a visually comfortable fully luminous surface

### Compliance

- Components are UL recognized
- cULus Damp Location listed for 25C ambient indoor environments
- Complies with IESNA LM-79 and LM-80 standards

### Warranty

- Five year warranty standard. Optional ten year warranty available

## Photometric Data

[View IES files](#)

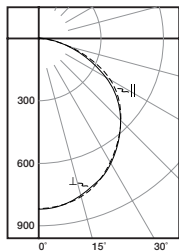

### 12EN-LD2-23-UNV-L835-CD1-U

Electronic Driver  
 Linear LED 3500K  
 Spacing criterion: (II) 1.3 x mounting height,  
 (L) 1.3 x mounting height  
 Lumens: 2395  
 Input Watts: 20.5W  
 Efficacy: 116.8 lm/W  
 Test Report: 12EN-LD2-23-UNV-L835-CD1-U.IES

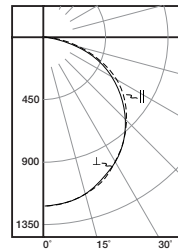

### 12EN-LD2-35-UNV-L835-CD1-U

Electronic Driver  
 Linear LED 3500K  
 Spacing criterion: (II) 1.3 x mounting height,  
 (L) 1.3 x mounting height  
 Lumens: 3560  
 Input Watts: 31.5W  
 Efficacy: 113.00 lm/W  
 Test Report: 12EN-LD2-35-UNV-L835-CD1-U.IES

## Energy and Performance Data

| Stock or MTO | Catalog Logic (Curved)     | Delivered Lumens | Watts | Efficacy (LPW) |
|--------------|----------------------------|------------------|-------|----------------|
| MTO          | 12EN-LD2-08-UNV-L835-CD1-U | 832              | 9.9   | 84             |
| MTO          | 12EN-LD2-13-UNV-L835-CD1-U | 1345             | 12.2  | 110            |
| MTO          | 12EN-LD2-17-UNV-L835-CD1-U | 1772             | 15.7  | 113            |
| MTO          | 12EN-LD2-23-UNV-L835-CD1-U | 2395             | 20.5  | 117            |
| MTO          | 12EN-LD2-27-UNV-L835-CD1-U | 2790             | 24.0  | 116            |
| MTO          | 12EN-LD2-31-UNV-L835-CD1-U | 3179             | 27.7  | 115            |
| MTO          | 12EN-LD2-35-UNV-L835-CD1-U | 3560             | 31.4  | 113            |
| MTO          | 12EN-LD2-39-UNV-L835-CD1-U | 3975             | 35.4  | 112            |

### Lumen Maintenance

| Ambient Temperature | TM-21 Lumen Maintenance (60,000 hours) <sup>(1)</sup> | Theoretical L70 (Hours) <sup>(2)</sup> |
|---------------------|---|--|
| 25°C                | > 92%   | > 130,000                              |

Notes: (1) Supported by IES TM-21 standards. (2) Theoretical values represent estimations commonly used; however, refer to the IES position on LED Product Lifetime Prediction, IES PS-10-18, that explains proper use of IES TM-21 and LM-80.

### Lumen Calculator

| CCT Multiplier | 80 CRI | 90 CRI |
|----------------|--------|--------|
| 3000K          | 0.970  | 0.835  |
| 3500K          | 1.000  | 0.864  |
| 4000K          | 1.020  | 0.901  |
| 5000K          | 1.110  | 0.955  |

### Shipping Data

| Catalog No. | Weight (lbs) | Units per Pallet 49"L x 52"W x 55"H |
|-------------|--------------|-------------------------------------|
| 12EN-LD2-13 | 8            | 27                                  |

## Control Systems

- WaveLinx
- DLVP
- Enlighted
- iLumin Plus
- VividTune



Connected Systems  
[CLICK HERE](#)

## Systems comparison chart

Cooper Lighting Solutions provides many lighting system solutions designed to satisfy code requirements and meet the unique needs of any project.

|  | Distributed Low-Voltage Power System | WaveLinx         | Enlighted |
|--|--------------------------------------|------------------|-----------|
| Space type                                   | Interior                             | Interior/Outdoor | Any       |
| Stand-alone or Network                       | Stand-alone                          | Both             | Network   |
| Need-based feature progression               |                                      |                  |           |
| <b>Basic compliance only</b>                 | •                                    | •                | •         |
| Occupancy sensing                            | •                                    | •                | •         |
| Daylight harvesting                          | •                                    | •                | •         |
| Zone control                                 | •                                    | •                | •         |
| Scheduling                                   | •                                    | •                | •         |
| 0-10V dimming                                | •                                    | •                | •         |
| Individual fixture control                   | •                                    | •                | •         |
| <b>Retrofit+Building Integration</b>         | •                                    | •                | •         |
| Total wireless connectivity                  |                                      | •                | •         |
| A/V integration                              |                                      | •                | •         |
| BMS integration                              |                                      | •                | •         |
| UI options (touchscreen, apps, etc.)         |                                      | •                | •         |
| <b>Enterprise level building integration</b> |                                      | •                | •         |
| Facility management & tools                  |                                      | •                | •         |
| Floor plan & reporting tools                 |                                      |                  | •         |
| <b>Value-added services</b>                  |                                      |                  | •         |
| Asset tracking                               |                                      |                  | •         |
| API integration                              |                                      | •                | •         |
| Analytics/higher problem solving             |                                      |                  | •         |

## Integrated Sensor

The Encounter with Integrated Sensor technology provides automatic energy savings without sacrificing performance. Traditionally, these types of energy savings required coordination between the luminaire and a lighting control system. The Encounter delivers superior lighting with integrated occupancy and daylighting controls.

Capture the benefits of traditional lighting controls, without complicated coverage planning or special wiring. Ideal for new construction or retrofit, the Encounter delivers automatic ON to an energy saving light level, while ensuring lighting is turned OFF when the space is unoccupied.

The integral daylight sensor reduces the need for special daylight zone planning. Each luminaire will automatically adjust the light level based on reflected light beneath the sensor in a closed loop method.

Occupied daylight light levels and unoccupied light levels can be adjusted using the integrated sensor programming remote (Catalog Number: ISHH-01). The integrated sensor personal remote (Catalog Number: ISHH-02) provides code compliant manual raise, lower, ON, OFF control.

The Encounter with Integrated Sensor is easy to install with no special wiring and ensures energy savings out-of-the-box with default control settings.

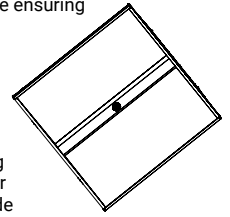

### How it works:

- As the user enters the space controlled by the integral sensor, the lighting turns ON to the default daylight level.
- Lighting will remain at that the daylight level until the space is unoccupied. This will start the occupancy timeout period (default 20 minutes).
- If the space remains unoccupied for half of the timeout period, the lighting will automatically reduce to the Energy Saver light level. This adjustable light level is typically half of the occupied daylight level.
- At the end of the timeout period the lighting will go to the unoccupied light level. This adjustable light level uses the OFF default setting.



### 12EN LED with VividTune Tunable White

VividTune tunable white luminaires from Cooper Lighting Solutions deliver high-quality light in a broad range of continuously variable color temperatures and intensities. Create a dynamic environment by adjusting the ambient light warmer or cooler to influence mood, support the task at hand, or create a dramatic ambience. The ability to control correlated color temperature and intensity separately using simple controls is the next evolution of LED lighting for the commercial, educational, healthcare and hospitality space. The unparalleled flexibility and number of available lighting environments enable users to find the right light with tunable white.

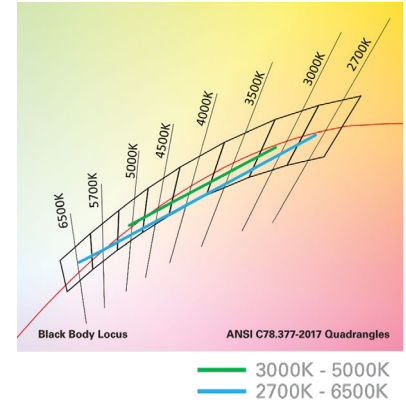

### Performance Data\*

| Tunable White - Lumen Adjustment Factors (example only) |             |        |             |        |
|---|-------------|--------|-------------|--------|
| CCT   | 3000K-5000K |        | 2700K-6500K |        |
|   | 80 CRI      | 90 CRI | 80 CRI      | 90 CRI |
| 2700K   | -           | -      | 0.871       | 0.719  |
| 3000K   | 0.943       | 0.788  | 0.879       | 0.742  |
| 3500K   | 0.958       | 0.806  | 0.908       | 0.759  |
| 4000K   | 0.963       | 0.837  | 0.895       | 0.793  |
| 4500K   | 0.976       | 0.842  | 0.922       | 0.787  |
| 5000K   | 0.977       | 0.846  | 0.920       | 0.808  |
| 6500K   | -           | -      | 0.925       | 0.828  |

| 1' x 2' Encounter LED - Example of Approximate Lumen Calculation |                            |                               |                               |
|--|----------------------------|-------------------------------|-------------------------------|
|  | Standard Catalog #         | VividTune 80 CRI Catalog #    | VividTune 90 CRI Catalog #    |
| CCT Setting  | 12EN-LD2-23-UNV-L835-CD1-U | 12EN-LD2-23-UNV-L83050-W2A1-U | 12EN-LD2-23-UNV-L93050-W2A1-U |
| 3000K  | -                          | 2259                          | 1886                          |
| 3500K  | 2395                       | 2296                          | 1930                          |
| 4000K  | -                          | 2305                          | 2005                          |
| 4500K  | -                          | 2336                          | 2016                          |
| 5000K  | -                          | 2339                          | 2025                          |

### Controlling VividTune Tunable White

VividTune luminaires make tunable white more accessible by using simple and familiar controls. From wall dimmers to wireless controls, VividTune tunable white luminaires are compatible with industry standard 0-10V dimming controls. A single 0-10V dimming input is used to control intensity (brightness) while a second 0-10V dimming input is used to adjust CCT. For suggested control configurations, [click here](#) for tunable white application guides.

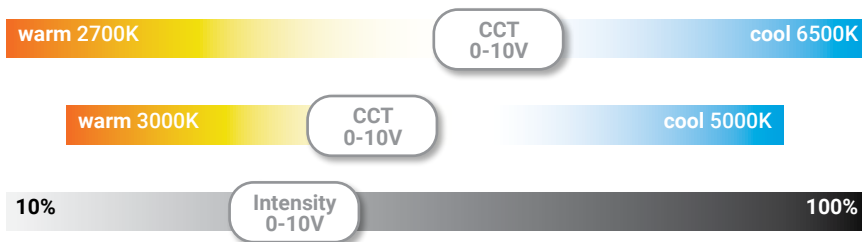

### Example of Lumen Adjustment Calculation

12EN-LD2-23-UNV-L83050-W2A1-U at 80 CRI tuned to 3500K

$$\text{Adjusted Lumen} = \text{published } lm \times \text{adjusted } lm \text{ factor}$$

$$\text{Adjusted Lumen} = 2395 * 0.958$$

$$\text{Adjusted Lumen} = 2296 \text{ lm}$$

\* Lumen adjustment factors are for reference and may be different for each product selected. Refer to IES files for actual performance data on each.