

**DESCRIPTION**

Specification grade 71 watt MR16 adjustable wet location pinhole fixture. Adjustment mechanism features hot aiming capabilities, aiming marks and toolless locking. Pinhole minimizes aperture appearance, and reflector provides 50° cutoff to lamp and lamp image. For use with all halogen MR16 lamp varieties. Units small size is ideal for tight construction areas. Insulation must be kept 3" away from sides and top of fixture. **Optical element can be changed after installation to provide a variety of distributions. e.g. into a Downlight.**

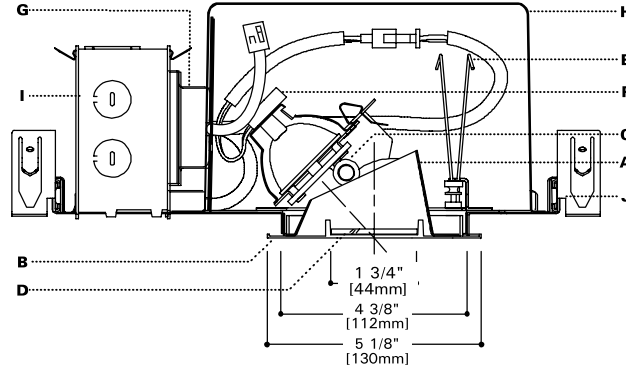

**SPECIFICATION FEATURES**

**A...Reflector**

.040 thick aluminum spun parabolic interior reflector in Black Alzak® finish.

**B...Flange**

Die-cast flange with matte white finish. Die-cast flanges are easily removed for field painting. Elements are keyed for proper insertion.

**C...Adjustability**

Removable lamp adjustment mechanism provides up to 45° tilt and 361° rotation and locks into any aiming position. Unit is relamped without unlocking adjustments. Translating centerbeam optics maximize light output.

**D...Lens**

Clear tempered glass lens seals for wet location. Soft focus lens standard in platform for smooth beam patterns. Up to two filter media can be used which are retained during relamping.

**E...Attachment**

Positive torsion springs pull flange tight to ceiling. Mechanical light trap eliminates spill light at edge of flange or reflector.

**F...Socket**

GX5.3 base for Bi-pin MR16 lamps. Back light shield keeps interior of fixture dark.

**G...Transformer**

Truvolt® toroidal transformer with dual-output taps for proper 12.0V operation. Dimmer tap compensates for inherent voltage loss from dimmers, resulting in 30% more lumens than traditional laminated transformers. Toroidal design, with 90% or greater efficiency, features a rolled one-piece continuous core of M3 grade grain oriented silicon steel complete with an integral thermal to protect against overheating and ensure quiet operation. For dimming, use dimmers

rated for electromagnetic transformers. **Transformer is warranted for 5 years and is serviceable from below ceiling.**

Note: If a dimming system is operated for construction lighting in its "shunt" mode, i.e. bypassing the dimmer modules, for an extended period of time, fixtures with the dual-tap toroidal transformer should be operated on the "Switched Fixture" output until the dimmers are in use. Operating fixtures on the "Dimmed Fixture" output with a full 120v input for an extended period will overdrive the lamp and cause shortened lamp life.

**H...Frame/Housing**

Hot dipped galvanized 20 gauge steel frame with built in 1/2 inch plaster lip. Gunsights allow for consistent alignment. Matte black housing interior.

**I...Junction Box**

18 cubic inches, listed for 4#12 AWG or 6#14 AWG 90° C additional feed through conductors, has three 1/2" pryouts.

**J...Bar Hangers**

No Flex® bar hangers with positive locking, for use with wood, engineered wood and steel frame joists spaced up to 24" O.C. ship with platform. For use in T-bar ceilings order accessory MBCLP. Nailless barb and locator lip provide consistent installation height.

**K...Codes**

Thermally protected, IP labeled. Unit is airtight and exchanges less than 2.0 CFM with the plenum at a pressure of 75 pascals. Insulation must be kept three inches away from fixture sides and none on top as to entrap heat.

**L...Labels**

UL and cUL listed, standard wet label, IBEW union made

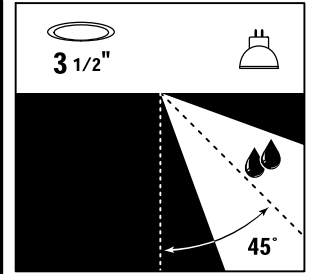

**PN3MR  
E3AASRPIN**

**71 W MR 16**

**3" ADJUSTABLE  
SHOWER PINHOLE**

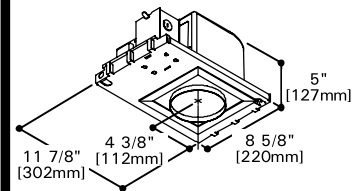

Ceiling Cutout  
4 3/8" (112mm)

**ENERGY DATA**

120V Input		
Lamp Watts	Input Watts	Operating Current
20	23	.19
35	41	.34
37	42	.35
42	47	.39
50	57	.48
65	70	.58
71	77	.64
75	81	.68

**ORDERING INFORMATION**

Complete unit consists of a platform and element

Platform	Optical Element	Flange	Accessories
<b>PN3MR</b>	<b>E3AASRPIN</b>		
PN3MR = 3" Non-IC Low Voltage Housing PN3MR REMOTE = 3" Non-IC Housing for Remote Transformer	E3AASRPIN = MR16 1-3/4" O-45° Adjustable Shower Pinhole	Blank = White Die Cast POL = Polished Aluminum SAL = Satin Aluminum	MBCLP = 40 Push On T Bar Clips (for 10 Units) PLE3 = Plaster Lip Extension for Max 2" Thick Ceiling LSPD = Spread Lens LLNR = Linear Spread Lens LUV = UV Reduction Lens LLPINK = Light Pink Lens LLSTRAW = Light Straw lens L27K = 2700K dichroic filter LDAY = Daylight Lens LSPINK = Surprise Pink Lens LPLAV = Pale Lavender Lens LHEX = Hex Cell Louver LSNOOT = SNOOT

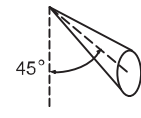
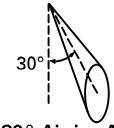
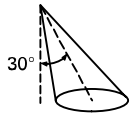
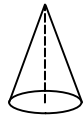
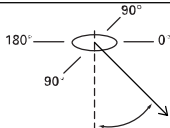

Lamp	Luminescence cd/m <sup>2</sup> @ Maximum Tilt	0° Aiming Angle Horizontal Footcandles				30° Aiming Angle Horizontal Footcandles					30° Aiming Angle Vertical Footcandles					45° Aiming Angle Vertical Footcandles						
		180°	90°	D	FC	L	W	D	FC	L	W	CB	D	FC	L	W	CB	D	FC	L	W	CB
GE Q20 MR16/C/VNSP7 Beam Spread: 7° CBCP: 7,400 Test # H21237	85°	0	0	6'	87	0.7	0.7	6'	38	0.8	0.8	2.3	2'	79	0.7	0.6	3.5	2'	172	0.4	0.4	2
	75°	0	0	8'	49	0.9	0.9	8'	22	1	1	4.0	3'	35	1.1	0.8	5.2	3'	76	0.6	0.6	3
	65°	0	0	10'	31	1.1	1.1	10'	14	1.4	1.5	5.8	4'	20	1.5	1.1	6.9	4'	43	0.8	0.7	4
	55°	0	0	12'6"	20	1.4	1.4	12'6"	9	1.7	1.8	7.2	5'	13	1.8	1.4	8.7	5'	28	1	0.9	5
	45°	1152	1382																			

Lamp	Luminescence cd/m <sup>2</sup> @ Maximum Tilt	0° Aiming Angle Horizontal Footcandles				30° Aiming Angle Horizontal Footcandles					30° Aiming Angle Vertical Footcandles					45° Aiming Angle Vertical Footcandles						
		180°	90°	D	FC	L	W	D	FC	L	W	CB	D	FC	L	W	CB	D	FC	L	W	CB
OS Q37 MR16/IR/SP10 Beam Spread: 10° CBCP: 13,100 Test # H21250	85°	0	0	6'	151	1.3	1.3	6'	87	1.8	1.6	3.5	2'	147	1.6	0.9	3.5	2'	329	1	0.7	2
	75°	0	0	8'	85	1.8	1.8	8'	49	2.4	2.2	4.6	3'	65	2.4	1.3	5.2	3'	146	1.4	1	3
	65°	0	0	10'	54	2.2	2.2	10'	31	3	2.7	5.8	4'	37	3.1	1.8	6.9	4'	82	1.9	1.3	4
	55°	284	284	12'6"	35	2.8	2.8	12'6"	20	3.8	3.4	7.2	5'	24	3.9	2.2	8.7	5'	53	2.4	1.7	5
	45°	3225	2304																			

Lamp	Luminescence cd/m <sup>2</sup> @ Maximum Tilt	0° Aiming Angle Horizontal Footcandles				30° Aiming Angle Horizontal Footcandles					30° Aiming Angle Vertical Footcandles					45° Aiming Angle Vertical Footcandles						
		180°	90°	D	FC	L	W	D	FC	L	W	CB	D	FC	L	W	CB	D	FC	L	W	CB
GE Q42 MR16/C/VNSP Beam Spread: 9° CBCP: 12,500 Test # H21209	85°	0	0	6'	123	0.8	1.8	6'	64	1.3	1.3	3.5	2'	121	1.1	0.8	3.5	2'	246	0.6	0.6	2
	75°	0	0	8'	69	1	2.4	8'	36	1.7	1.7	4.6	3'	54	1.6	1.1	5.2	3'	109	0.9	0.9	3
	65°	0	0	10'	44	1.3	3	10'	23	2.1	2.1	5.8	4'	30	2.2	1.5	6.9	4'	61	1.2	1.2	4
	55°	0	0	12'6"	28	1.6	3.8	12'6"	15	2.6	2.7	7.2	5'	19	2.7	1.9	8.7	5'	39	1.5	1.5	5
	45°	0	0																			

Lamp	Luminescence cd/m <sup>2</sup> @ Maximum Tilt	0° Aiming Angle Horizontal Footcandles				30° Aiming Angle Horizontal Footcandles					30° Aiming Angle Vertical Footcandles					45° Aiming Angle Vertical Footcandles						
		180°	90°	D	FC	L	W	D	FC	L	W	CB	D	FC	L	W	CB	D	FC	L	W	CB
PH Q45 MRC16/IRC/SP8 Beam Spread: 8° CBCP: 16,000 Test # H21226	85°	0	15719	6'	171	1	1	6'	79	1.5	1.5	3.5	2'	159	1.3	0.8	3.5	2'	324	0.7	0.6	2
	75°	0	5293	8'	96	1.4	1.4	8'	45	2.1	2	4.6	3'	70	2	1.2	5.2	3'	144	1.1	1	3
	65°	0	3242	10'	62	1.7	1.7	10'	29	2.6	2.5	5.8	4'	40	2.6	1.6	6.9	4'	81	1.4	1.3	4
	55°	0	2389	12'6"	39	2.2	2.2	12'6"	18	3.2	3.1	7.2	5'	25	3.3	2	8.7	5'	52	1.8	1.6	5
	45°	0	0																			

Lamp	Luminescence cd/m <sup>2</sup> @ Maximum Tilt	0° Aiming Angle Horizontal Footcandles				30° Aiming Angle Horizontal Footcandles					30° Aiming Angle Vertical Footcandles					45° Aiming Angle Vertical Footcandles						
		180°	90°	D	FC	L	W	D	FC	L	W	CB	D	FC	L	W	CB	D	FC	L	W	CB
GE Q50 MR16/C/NSP15 Beam Spread: 15° CBCP: 9,500 Test # H212398	85°	0	0	6'	154	1.3	1.3	6'	82	1.7	1.7	3.5	2'	171	1.4	0.9	3.5	2'	345	0.8	0.7	2
	75°	0	0	8'	87	1.8	1.8	8'	46	2.3	2.3	4.6	3'	76	2.1	1.4	5.2	3'	153	1.2	1	3
	65°	0	0	10'	56	2.2	2.2	10'	30	2.8	2.8	5.8	4'	43	2.8	1.8	6.9	4'	86	1.6	1.3	4
	55°	0	0	12'6"	36	2.8	2.8	12'6"	19	3.5	3.5	7.2	5'	27	3.5	2.3	8.7	5'	55	2	1.7	5
	45°	0	0																			

Lamp	Luminescence cd/m <sup>2</sup> @ Maximum Tilt	0° Aiming Angle Horizontal Footcandles				30° Aiming Angle Horizontal Footcandles					30° Aiming Angle Vertical Footcandles					45° Aiming Angle Vertical Footcandles						
		180°	90°	D	FC	L	W	D	FC	L	W	CB	D	FC	L	W	CB	D	FC	L	W	CB
GE Q50 MR16/CN/FL25 Beam Spread: 25° CBCP: 3,000 Test # H21185	85°	0	1847	6'	73	1.8	1.8	6'	38	2.6	2.3	3.5	2'	78	2.1	1.3	3.5	2'	148	1.1	1	2
	75°	622	622	8'	41	2.4	2.4	8'	22	3.4	3.1	4.6	3'	35	3.2	1.9	5.2	3'	66	1.7	1.5	3
	65°	381	381	10'	26	3	3	10'	14	4.3	3.9	5.8	4'	20	4.3	2.5	6.9	4'	37	2.3	1.9	4
	55°	561	561	12'6"	17	3.8	3.8	12'6"	9	5.4	4.9	7.2	5'	13	5.3	3.2	8.7	5'	24	2.8	2.4	5
	45°	1366	1366																			

Lamp	Luminescence cd/m <sup>2</sup> @ Maximum Tilt	0° Aiming Angle Horizontal Footcandles				30° Aiming Angle Horizontal Footcandles					30° Aiming Angle Vertical Footcandles					45° Aiming Angle Vertical Footcandles						
		180°	90°	D	FC	L	W	D	FC	L	W	CB	D	FC	L	W	CB	D	FC	L	W	CB
GE Q50 MR16/C/FL40 Beam Spread: 40° CBCP: 1,700 Test # H22402	85°	0	0	6'	38	3.2	2.5	6'	22	3.1	3	3.5	2'	75	2	1.4	3.5	2'	101	1.6	1.3	2
	75°	0	0	8'	21	4.2	3.4	8'	13	4.1	4	4.6	3'	33	3	2.1	5.2	3'	45	2.4	1.9	3
	65°	0	0	10'	14	5.3	4.2	10'	8	5.2	5.1	5.8	4'	19	4.1	2.8	6.9	4'	25	3.2	2.6	4
	55°	0	0	12'6"	9	6.6	5.3	12'6"	5	6.5	6.3	7.2	5'	12	5.1	3.5	8.7	5'	16	4	3.2	5
	45°	0	0																			

Lamp	Luminescence cd/m <sup>2</sup> @ Maximum Tilt	0° Aiming Angle Horizontal Footcandles				30° Aiming Angle Horizontal Footcandles					30° Aiming Angle Vertical Footcandles					45° Aiming Angle Vertical Footcandles					
		D	FC	L	W	D	FC	L	W	CB	D	FC	L	W	CB	D	FC	L	W	CB	
OS Q65 MR16/Q/NSP/10 Beam Spread: 10° CBCP: 12,500 Test # H21270	85°	89	1.4	1.4	6'	51	1.6	1.7	3.5	2'	99	1.3	0.8	3.5	2'	209	0.6	0.7	2		
	75°	50	1.9	1.9	8'	28	2.1	2.3	4.6	3'	44	1.9	1.3	5.2	3'	93	1	1	3		
	65°	32	2.4	2.4	10'	18	2.6	2.9	5.8	4'	25	2.5	1.7	6.9	4'	52	1.3	1.3	4		
	55°	20	3	3	12'6"	12	3.3	3.6	7.2	5'	16	3.2	2.1	8.7	5'	33	1.6	1.7	5		
	45°																				

Lamp	Luminescence cd/m <sup>2</sup> @ Maximum Tilt	0° Aiming Angle Horizontal Footcandles				30° Aiming Angle Horizontal Footcandles					30° Aiming Angle Vertical Footcandles					45° Aiming Angle Vertical Footcandles					
		D	FC	L	W	D	FC	L	W	CB	D	FC	L	W	CB	D	FC	L	W	CB	
Q65 MR16/Q/FL40 Beam Spread: 40° CBCP: 2,100 Test # H21262	85°	51	2.4	2.4	6'	31	3.1	3	3.5	2'	65	2.1	1.5	3.5	2'	128	1.3	1.2	2		
	75°	29	3.2	3.2	8'	18	4.2	4	4.6	3'	29	3.1	2.3	5.2	3'	57	2	1.8	3		
	65°	18	4	4	10'	11	5.2	5	5.8	4'	16	4.1	3.1	6.9	4'	32	2.7	2.4	4		
	55°	12	5	5	12'6"	7	6.5	6.2	7.2	5'	10	5.2	3.8	8.7	5'	21	3.3	3	5		
	45°																				

Notes and Definitions:

Luminescence: To convert cd/m<sup>2</sup> to footlamberts, multiply by 0.2919

- Data is based upon bare lamps photometrics. Photometrics shown were tested with the E3PIN.
- Beam spread is to 50% center beam candlepower (CBCP).

IRIS believes that bare lamp data photometrics vastly overstate the performance of low voltage adjustable accent fixtures.

The "real world photometrics" shown here are from off the shelf lamps in fixtures using a clear lens and operated at 12.0 volts. Please see page 64 & 65 of the IRIS catalog for a further discussion and appropriate correction multipliers.

D = Distance to floor or wall.  
 FC = Footcandles on floor or wall at center beam aiming location.  
 L = Effective Visual Beam length in feet (50% of maximum footcandle level.)  
 W = Effective Visual Beam width in feet (50% of maximum footcandle level.)  
 CB = Distance across or down to center beam location.

Specifications and Dimensions subject to change without notice.

