

DESCRIPTION

The EPIC Collection delivers custom luminaire flexibility with high quality, yet availability expectations of standard specification grade product. The EPIC Collection can be dressed to suit any application. Recognizing evolving environmental and legislative trends, the EPIC Collection delivers world class LED optical and performance solutions to the decorative luminaire marketplace.

Catalog #		Type
Project		
Comments		Date
Prepared by		

SPECIFICATION FEATURES

Construction

TOP: Cast aluminum top housing attaches to cast aluminum mounting arm hub with four stainless steel fasteners. One-piece silicone gasket between mounting hub and top casting seals out moisture and contaminants. (See the mounting accessories section for a full selection of mounting arms. (Only these arms are compatible with the Epic luminaire). **MIDSECTION:** Continuous silicone gaskets seal lens to top casting and shade. The mid section features cast aluminum construction and stainless steel assembly. **SHADES:** Heavy gauge precision spun aluminum shades offer superior surface finish and consistency in form. **DOORFRAME:** Die-cast aluminum 1/8" thick door and doorframe seal to underside of shade with a thick wall continuous silicone gasket. Mounting hub ships attached to mounting arm.

Optics

Choice of twelve patented, high-efficiency AccuLED Optic™ technology manufactured from

injection-molded acrylic. Optics are precisely designed to shape the optics, maximizing efficiency and application spacing. AccuLED Optic technology, creates consistent distributions with the scalability to meet customized application requirements. Offered Standard in 4000K (+/- 275K) CCT and nominal 70 CRI. Optional 3000K CCT and 5000K CC. For the ultimate level of spill light control, an optional house-side shield accessory can be field or factory installed. The house-side shield is designed to seamlessly integrate with the SL2, SL3 or SL4 optics.

Electrical

LED drivers mount to die-cast aluminum back housing for optimal heat sinking, operation efficacy, and prolonged life. Standard drivers feature electronic universal voltage (120-277V 50/60Hz), 347V 60Hz or 480V 60Hz operation, greater than 0.9 power factor, less than 20% harmonic distortion, and is suitable for operation in -40°C to 40°C ambient environments. All fixtures are shipped standard

with 10kV/10kA common – and differential – mode surge protection. LightBARs feature and IP66 enclosure rating and maintain greater than 95% lumen maintenance at 60,000 hours per IESNA TM-21. Occupancy sensor and dimming options available.

Finish

Housing is finished in five-stage super TGIC polyester powder coat paint, 2.5 mil nominal thickness for superior protection against fade and wear. LightBAR™ cover plates are standard white and may be specified to match finish of luminaire housing. Standard colors include black, bronze, grey, white, dark platinum and graphite metallic. RAL and custom color matches available. Consult Outdoor Architectural Colors brochure for a complete selection.

Warranty

Five-year warranty.



ECM/EMM EPIC MEDIUM LED

1 - 4 LightBARs
Solid State LED

DECORATIVE AREA LUMINAIRE



CERTIFICATION DATA

UL/cUL Listed
DesignLights Consortium® Qualified*
IP66 LightBARs
LM79 / LM80 Compliant
2G Vibration Tested
ISO 9001

ENERGY DATA

Electronic LED Driver
>0.9 Power Factor
<20% Total Harmonic Distortion
120-277V 50/60Hz, 347V/60Hz,
480V/60Hz
-40°C Minimum Temperature
40°C Ambient Temperature Rating

EPA

Effective Projected Area: (Sq. Ft.) 0.94

SHIPPING DATA

Approximate Net Weight:
45 lbs. [20 kgs.]

DIMENSIONS

ECM Classical

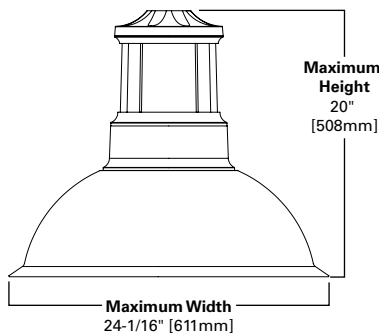

EMM Modern

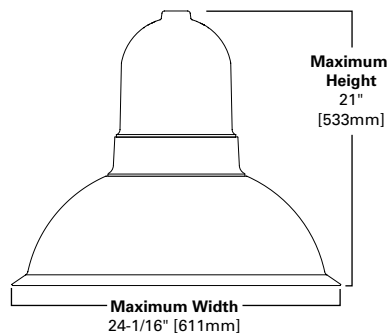

See configurations for more detailed information.

CONFIGURATIONS

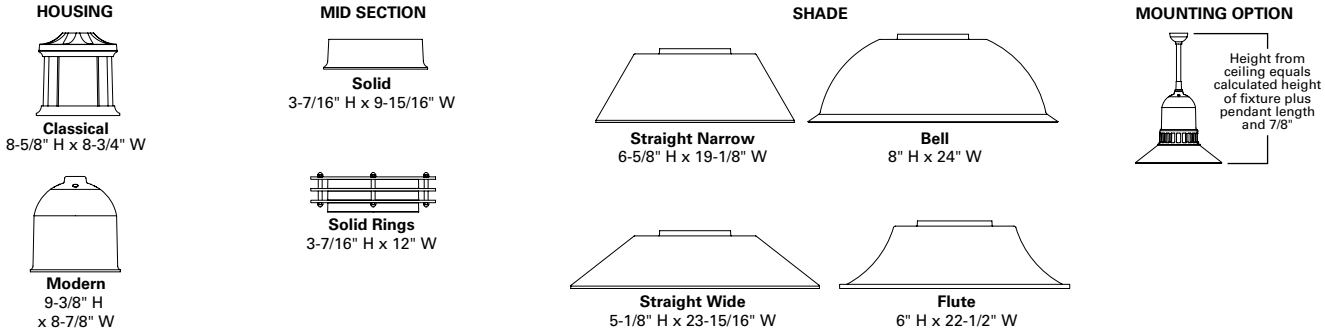

POWER AND LUMENS BY BAR COUNT (21 LED LIGHTBARS)

Number of LightBARs	E01	E02	E03	E04	
Drive Current	350mA Drive Current				
Power (Watts)	25W	52W	75W	97W	
Current @ 120V (A)	0.22	0.44	0.63	0.82	
Current @ 277V (A)	0.10	0.20	0.28	0.36	
Power (Watts)	31W	58W	82W	99W	
Current @ 347V (A)	0.11	0.19	0.28	0.29	
Current @ 480V (A)	0.09	0.15	0.20	0.21	
T2	Lumens	2,948	5,896	8,844	11,792
	BUG Rating	B1-U0-G1	B2-U0-G2	B3-U0-G3	B3-U0-G3
T3	Lumens	2,936	5,873	8,809	11,745
	BUG Rating	B1-U0-G1	B2-U0-G2	B3-U0-G3	B3-U0-G3
T4	Lumens	2,876	5,752	8,627	11,503
	BUG Rating	B1-U0-G1	B1-U0-G2	B1-U0-G2	B2-U0-G3
5MQ	Lumens	3,054	6,108	9,161	12,215
	BUG Rating	B2-U0-G1	B3-U0-G1	B3-U0-G2	B4-U0-G2
5WQ	Lumens	2,987	5,975	8,962	11,949
	BUG Rating	B2-U0-G1	B3-U0-G1	B3-U0-G2	B4-U0-G2
5XQ	Lumens	2,982	5,963	8,945	11,926
	BUG Rating	B2-U0-G1	B3-U0-G2	B3-U0-G3	B4-U0-G3
SL2	Lumens	2,878	5,756	8,634	11,512
	BUG Rating	B1-U0-G1	B1-U0-G2	B2-U0-G2	B2-U0-G2
SL3	Lumens	2,894	5,788	8,682	11,576
	BUG Rating	B1-U0-G1	B1-U0-G2	B2-U0-G2	B2-U0-G2
SL4	Lumens	2,823	5,647	8,470	11,294
	BUG Rating	B1-U0-G1	B1-U0-G2	B2-U0-G2	B2-U0-G2
RW	Lumens	2,957	5,915	8,872	11,829
	BUG Rating	B2-U0-G2	B3-U0-G3	B3-U0-G3	B3-U0-G3
SLL/SLR	Lumens	2,616	5,231	7,847	10,462
	BUG Rating	B1-U0-G2	B1-U0-G2	B1-U0-G3	B2-U0-G3

POWER AND LUMENS BY BAR COUNT (7 LED LIGHTBARS)

Number of LightBARs	F01	F02	F03	F04	
Drive Current	1A Drive Current				
Power (Watts)	26W	55W	78W	102W	
Current @ 120V (A)	0.22	0.46	0.66	0.86	
Current @ 277V (A)	0.10	0.21	0.29	0.37	
Power (Watts)	32W	60W	85W	105W	
Current @ 347V (A)	0.11	0.19	0.28	0.30	
Current @ 480V (A)	0.09	0.15	0.21	0.22	
T2	Lumens	2,434	4,867	7,301	9,735
	BUG Rating	B1-U0-G1	B2-U0-G2	B2-U0-G2	B3-U0-G3
T3	Lumens	2,424	4,848	7,272	9,696
	BUG Rating	B1-U0-G1	B2-U0-G2	B2-U0-G2	B3-U0-G3
T4	Lumens	2,374	4,748	7,122	9,496
	BUG Rating	B1-U0-G1	B1-U0-G2	B1-U0-G2	B2-U0-G2
5MQ	Lumens	2,521	5,042	7,563	10,084
	BUG Rating	B2-U0-G1	B3-U0-G1	B3-U0-G1	B3-U0-G2
5WQ	Lumens	2,466	4,932	7,398	9,864
	BUG Rating	B2-U0-G1	B3-U0-G1	B3-U0-G2	B4-U0-G2
5XQ	Lumens	2,461	4,923	7,384	9,845
	BUG Rating	B2-U0-G1	B3-U0-G2	B3-U0-G2	B4-U0-G3
SL2	Lumens	2,376	4,752	7,127	9,503
	BUG Rating	B1-U0-G1	B1-U0-G1	B2-U0-G2	B2-U0-G2
SL3	Lumens	2,389	4,778	7,167	9,556
	BUG Rating	B1-U0-G1	B1-U0-G1	B1-U0-G2	B2-U0-G2
SL4	Lumens	2,331	4,662	6,993	9,323
	BUG Rating	B1-U0-G1	B1-U0-G2	B1-U0-G2	B2-U0-G2
RW	Lumens	2,441	4,883	7,324	9,765
	BUG Rating	B1-U0-G1	B2-U0-G2	B3-U0-G3	B3-U0-G3
SLL/SLR	Lumens	2,159	4,318	6,478	8,637
	BUG Rating	B1-U0-G1	B1-U0-G2	B1-U0-G3	B1-U0-G3

LUMEN MAINTENANCE

Ambient Temperature	25,000 Hours*	50,000 Hours*	60,000 Hours*	100,000 Hours	Theoretical L70 (Hours)
25°C	> 99%	> 97%	> 96%	> 93%	> 450,000
40°C	> 98%	> 97%	> 96%	> 92%	> 425,000
50°C	> 97%	> 96%	> 95%	> 91%	> 400,000

* Per IESNA TM-21 data.

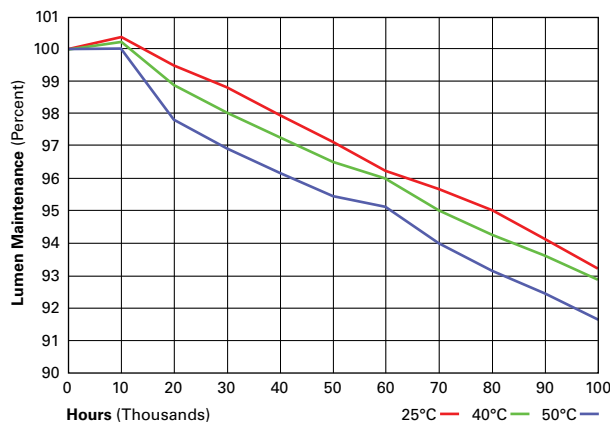

LUMEN MULTIPLIER

Ambient Temperature	Lumen Multiplier
10°C	1.02
15°C	1.01
25°C	1.00
40°C	0.99
50°C	0.96

CONTROL OPTIONS

0-10V (DIM)

The DIM option provides 0-10V dimming wire leads for use with a lighting control panel or other control method.

Photocontrol (PC, PER and PER7)

Optional button-type photocontrol (PC) and photocontrol receptacles (PER and PER7) provide a flexible solution to enable "dusk-to-dawn" lighting by sensing light levels. Advanced control systems compatible with NEMA 7-pin standards can be utilized with the PER7 receptacle.

Dimming Occupancy Sensor (MS/DIM-LXX, MS/X-LXX and MS-LXX)

These sensors are factory installed in the luminaire housing. When the MS/DIM-LXX sensor option is selected, the occupancy sensor is connected to a dimming driver and the entire luminaire dims when there is no activity detected. When activity is detected, the luminaire returns to full light output. The MS/DIM sensor is factory preset to dim down to approximately 50 percent power with a time delay of five minutes. The MS-LXX sensor is factory preset to turn the luminaire off after five minutes of no activity. The MS/X-LXX is also preset for five minutes and only controls the specified number of light engines to maintain steady output from the remaining light engines.

These occupancy sensors includes an integral photocell that can be activated with the FSIR-100 accessory for "dusk-to-dawn" control or daylight harvesting - the factory preset is OFF. The FSIR-100 is a wireless tool utilized for changing the dimming level, time delay, sensitivity and other parameters.

A variety of sensor lens are available to optimize the coverage pattern for mounting heights from 8'-40'.

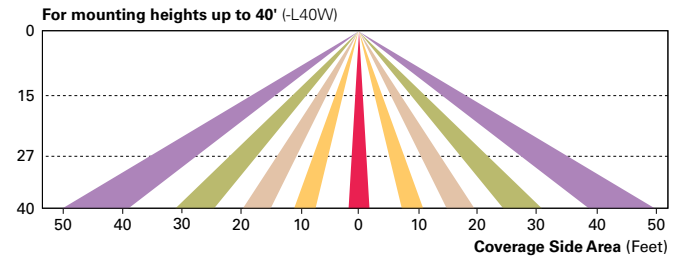
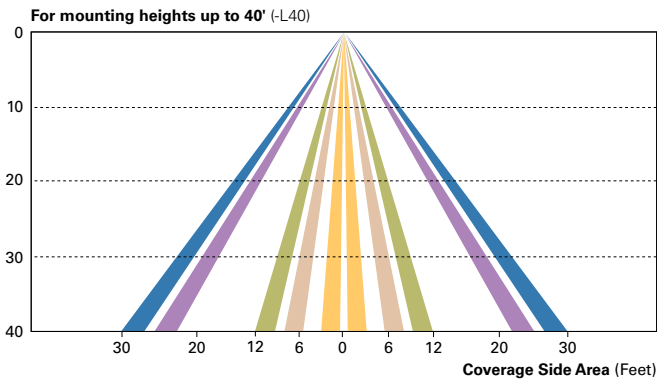
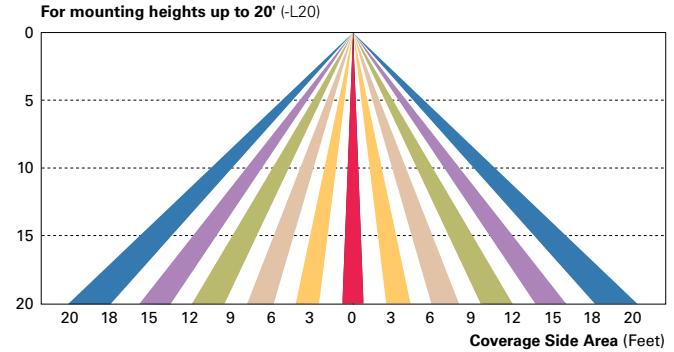
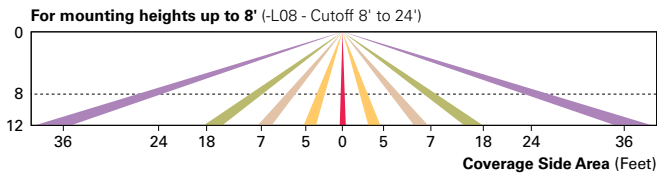

LumaWatt Pro Wireless Control and Monitoring System (LWR-LW and LWR-LN)

The LumaWatt Pro system is a peer-to-peer wireless network of luminaire-integral sensors for any sized project. Each sensor is capable of motion and photo sensing, metering power consumption and wireless communication. The end-user can securely create and manage sensor profiles with browser-based management software. The software will automatically broadcast to the sensors via wireless gateways for zone-based and individual luminaire control. The LumaWatt Pro software provides smart building solutions by utilizing the sensor to provide easy-to-use dashboard and analytic capabilities such as improved energy savings, traffic flow analysis, building management software integration and more.

For additional details, refer to the LumaWatt Pro product guides.

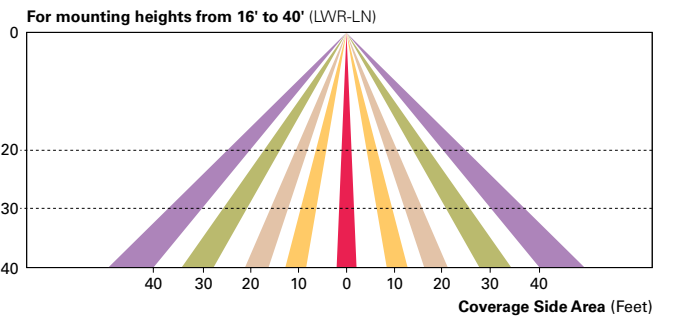
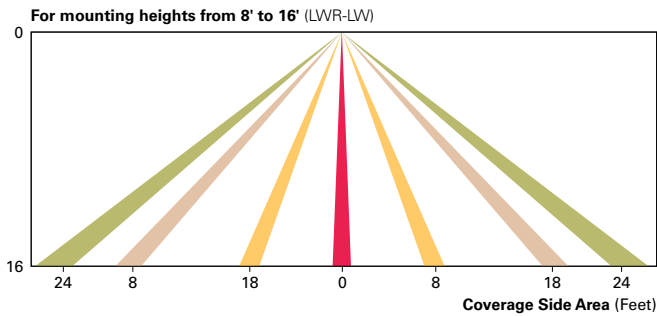

ORDERING INFORMATION

Sample Number: ECM-E04-LED-E1-T2-FL-GM

Product Family ¹	Number of LightBARs ^{2,3}	Lamp Type	Voltage	Distribution	Mid Section Type	Shade Type	Color ⁵
ECM =Epic Classical Medium EMM =Epic Modern Medium	E01 =(1) 21 LED LightBAR E02 =(2) 21 LED LightBARs E03 =(3) 21 LED LightBARs E04 =(4) 21 LED LightBARs F01 =(1) 7 LED LightBAR F02 =(2) 7 LED LightBARs F03 =(3) 7 LED LightBARs F04 =(4) 7 LED LightBARs	LED =Solid State Light Emitting Diodes	E1 =Electronic (120-277V) 347 =347V 480 =480V ⁴	T2 =Type II T3 =Type III T4 =Type IV SL2 =Type II w/Spill Control SL3 =Type III w/Spill Control SL4 =Type IV w/Spill Control 5MQ =Type V Square Medium 5WQ =Type V Square Wide 5XQ =Type V Square Extra Wide RW =Rectangular Wide SLL =90° Spill Light Eliminator Left SLR =90° Spill Light Eliminator Right	SQ =Solid SR =Solid Rings	SN =Straight Narrow SW =Straight Wide BL =Bell FL =Flute	AP =Grey BZ =Bronze BK =Black DP =Dark Platinum GM =Graphitic Metallic WH =White
Options (Add as Suffix)		Accessories (Order Separately) ¹³					
2L =Two Circuits ⁶ 7030 =70 CRI / 3000K CCT ⁷ 7050 =70 CRI / 5000K CCT ⁷ 8030 =80 CRI / 3000K CCT ⁷ LCF =LightBAR Cover Plate Matches Housing Finish MS-LXX =Motion Sensor for ON/OFF Operation ⁸ MS/X-LXX =Motion Sensor for Bi-Level Switching ⁹ PMXX =Pendant Mount (XX=Pendant Length in Inches, 9.5" min - 48.0" max) ¹⁰ HSS =Factory Installed House Side Shield ¹¹ DIM =0-10V Dimming Driver ¹²		OA/RA1016 =NEMA Twistlock Photocontrol - Multi-Tap OA/RA1027 =NEMA Twistlock Photocontrol - 480V OA/RA1201 =NEMA Twistlock Photocontrol - 347V OA/RA1013 =Photocontrol Shorting Cap LB/HSS-21 =Field Installed House Side Shield for "E" LightBARs ^{11,15} LB/HSS-07 =Field Installed House Side Shield for "F" LightBARs ^{11,15} Mounting Accessories (Order Separately) Classical VA6150-XX =Bishop Wall Mount Arm VA6151-XX =Bishop Wall Mount Arm with Cross Rod VA6152-XX =Traditional Wall Mount Arm VA6153-XX =Traditional Wall Mount Arm with 45° Strap VA6154-XX =Bishop Single Pole Mount Arm VA6155-XX =Bishop Single Pole Mount Arm with Cross Rod VA6156-XX =Bishop Twin Pole Mount Arm VA6157-XX =Bishop Twin Pole Mount Arm with Cross Rods VA6158-XX =Traditional Single Pole Mount Arm VA6159-XX =Traditional Single Pole Mount Arm with Rounded Upper Bar VA6160-XX =Traditional Single Pole Mount Arm with Rounded Lower Bar ¹⁴ VA6161-XX =Traditional Single Pole Mount Arm with 45° Upper Bar VA6162-XX =Traditional Single Pole Mount Arm with 45° Lower Bar ¹⁴ VA6163-XX =Traditional Single Pole Mount Arm with 45° Upper Strap VA6165-XX =Traditional Twin Pole Mount Arm VA6166-XX =Traditional Twin Pole Mount Arm with Rounded Upper Bars VA6167-XX =Traditional Twin Pole Mount Arm with Rounded Lower Bars ¹⁴ VA6168-XX =Traditional Twin Pole Mount Arm with 45° Upper Bars VA6169-XX =Traditional Twin Pole Mount Arm with 45° Lower Bars ¹⁴ VA6170-XX =Traditional Twin Pole Mount Arm with 45° Upper Straps VA6171-XX =Mast Arm Adapter Modern VA6101-XX =Bishop Wall Mount Arm VA6102-XX =Bishop Wall Mount Arm with Cross Rod VA6103-XX =Traditional Wall Mount Arm VA6104-XX =Traditional Wall Mount Arm with 45° Strap VA6105-XX =Bishop Single Pole Mount Arm VA6106-XX =Bishop Single Pole Mount Arm with Cross Rod VA6107-XX =Bishop Twin Pole Mount Arm VA6108-XX =Bishop Twin Pole Mount Arm with Cross Rods VA6109-XX =Traditional Single Pole Mount Arm VA6110-XX =Traditional Single Pole Mount Arm with Rounded Upper Bar VA6111-XX =Traditional Single Pole Mount Arm with Rounded Lower Bar ¹⁴ VA6112-XX =Traditional Single Pole Mount Arm with 45° Upper Bar VA6113-XX =Traditional Single Pole Mount Arm with 45° Lower Bar ¹⁴ VA6114-XX =Traditional Single Pole Mount Arm with 45° Upper Strap VA6116-XX =Traditional Twin Pole Mount Arm VA6117-XX =Traditional Twin Pole Mount Arm with Rounded Upper Bars VA6118-XX =Traditional Twin Pole Mount Arm with Rounded Lower Bars ¹⁴ VA6119-XX =Traditional Twin Pole Mount Arm with 45° Upper Bars VA6120-XX =Traditional Twin Pole Mount Arm with 45° Lower Bars ¹⁴ VA6121-XX =Traditional Twin Pole Mount Arm with 45° Upper Straps VA6122-XX =Mast Arm Adapter				Accessory Options ¹⁶ V =Victorian Finial ¹⁷ M =Modern Finial ¹⁷ A =Architectural Finial ¹⁷ N =Nostalgic Finial ¹⁷ R =NEMA Twistlock Photocontrol Receptacle ¹⁸	

- NOTES:**
1. Arm not included. Order separately. See accessories.
 2. Standard 4000K CCT and greater than 70 RL.
 3. 21 LED LightBAR powered by 350mA and 7 LED LightBAR powered by 1A.
 4. Only for use with 480V Wye systems. Per NEC, not for use with ungrounded systems, impedance grounded systems or corner grounded systems (commonly known as Three Phase Three Wire Delta, Three Phase High Leg Delta and Three Phase Corner Grounded Delta systems).
 5. Custom and RAL color matching available upon request. Consult your lighting representative at Cooper Lighting Solutions for more information.
 6. Low-level output varies by bar count. Consult factory. Requires quantity of two or more LightBARs.
 7. Consult customer service for lead times and multiplier.
 8. Sensor mounted to the luminaire. Available in E01-E04 and F01-F04 configurations. Replace "XX" with mounting height in feet for proper lens selection, (e.g., MS-L25). Consult factory for additional information.
 9. Sensor mounted to the luminaire. Available in E02-E04 and F02-F04 configurations. Replace "X" with number of LightBARs operating in low output mode and replace XX with mounting height in feet for proper lens selection, (e.g., MS/3-L25). Maximum four bars in low output mode. Consult factory for additional information.
 10. Pendant mount option "PMXX" must be used with Invue Pendant mount kit only. Includes pendant pipe, swivel hangar and canopy cover. Other pendant lengths can be specified in inches (XX). Minimum pendant length is 9-1/2". For lengths above 48", consult your lighting representative at Cooper Lighting Solutions for more information.
 11. Only for use with SL2, SL3 and SL4 distributions.
 12. Dimming leads provide for external 0-10V control system (by others).
 13. Replace XX with color suffix.
 14. Only available with traditional arms.
 15. One required for each LightBAR.
 16. Add as suffix to mounting accessory. Example: VA6106-BK-R.
 17. Not available with finials, pendant mount "PM48" or bishop wall mounts.
 18. Requires use of 4" O.D. round straight pole.

MOUNTING ACCESSORIES

Pole mount arms are designed to fit both medium ECM/EMM housings. (Only these arms are compatible with the Epic luminaire). Arms feature a precision welded cast aluminum mounting hub for attachment of fixture head to arm with four stainless steel fasteners. Wall mount arms compliment pole mount luminaires and attractively transition fixture scale in lower mounting height pedestrian environments. Wall mount arms are designed to fit both medium ECM/EMM housings. Arms feature a precision welded cast aluminum mounting hub for attachment of fixture head to arm with four stainless steel fasteners.

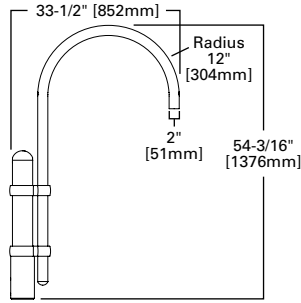

BISHOP SINGLE POLE MOUNT ARM
VA6105 (Modern), VA6154 (Classical)
Slipfits over 4" round straight pole, or 4" O.D. by 6" tall round tenon.
Weight: 24 lbs. E.P.A: 0.92

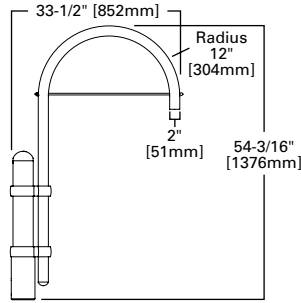

BISHOP SINGLE POLE MOUNT ARM WITH CROSS ROD
VA6106 (Modern), VA6155 (Classical)
Slipfits over 4" round straight pole, or 4" O.D. by 6" tall round tenon.
Weight: 25 lbs. E.P.A: 0.98

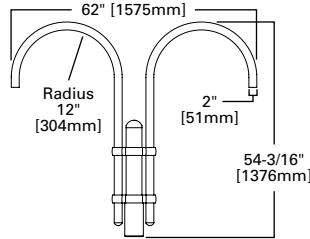

BISHOP TWIN POLE MOUNT ARM
VA6107 (Modern), VA6156 (Classical)
Slipfits over 4" round straight pole, or 4" O.D. by 6" tall round tenon.
Weight: 37 lbs. E.P.A: 1.43

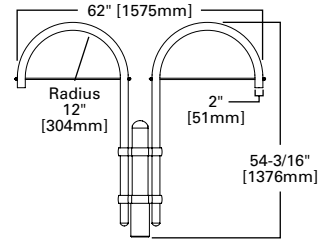

BISHOP TWIN POLE MOUNT ARM WITH CROSS RODS
VA6108 (Modern), VA6157 (Classical)
Slipfits over 4" round straight pole, or 4" O.D. by 6" tall round tenon.
Weight: 39 lbs. E.P.A: 1.55

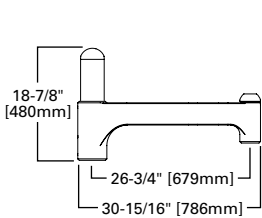

TRADITIONAL SINGLE POLE MOUNT ARM
VA6109 (Modern), VA6158 (Classical)
Slipfits over 4" round straight pole, or 4" O.D. by 6" tall round tenon.
Weight: 20 lbs. E.P.A: 0.86

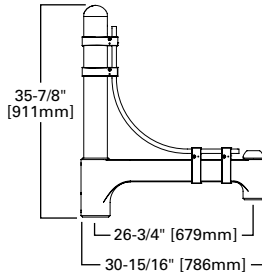

TRADITIONAL SINGLE POLE MOUNT ARM WITH ROUNDED UPPER BAR
VA6110 (Modern), VA6159 (Classical)
Slipfits over 4" round straight pole, or 4" O.D. by 6" tall round tenon.
Weight: 28 lbs. E.P.A: 1.4

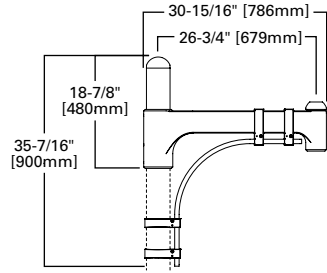

TRADITIONAL SINGLE POLE MOUNT ARM WITH ROUNDED LOWER BAR
VA6111 (Modern), VA6160 (Classical)
Slipfits over 4" round straight pole, or 4" O.D. by 6" tall round tenon.
Weight: 25 lbs. E.P.A: 1.16

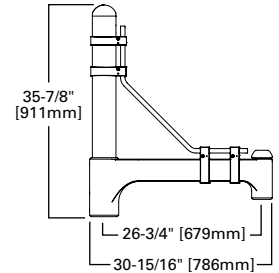

TRADITIONAL SINGLE POLE MOUNT ARM WITH 45° UPPER BAR
VA6112 (Modern), VA6161 (Classical)
Slipfits over 4" round straight pole, or 4" O.D. by 6" tall round tenon.
Weight: 28 lbs. E.P.A: 1.38

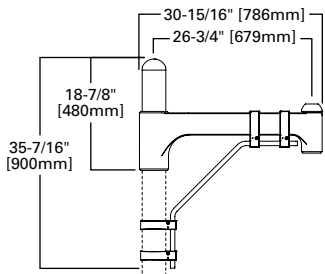

TRADITIONAL SINGLE POLE MOUNT ARM WITH 45° LOWER BAR
VA6113 (Modern), VA6162 (Classical)
Slipfits over 4" round straight pole, or 4" O.D. by 6" tall round tenon.
Weight: 24 lbs. E.P.A: 1.17

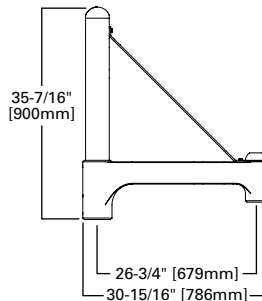

TRADITIONAL SINGLE POLE MOUNT ARM WITH 45° UPPER STRAP
VA6114 (Modern), VA6163 (Classical)
Slipfits over 4" round straight pole, or 4" O.D. by 6" tall round tenon.
Weight: 24 lbs. E.P.A: 1.17

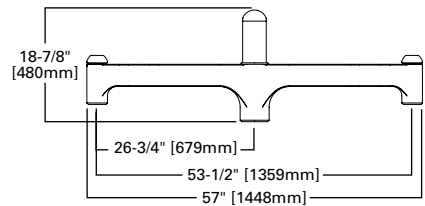

TRADITIONAL TWIN POLE MOUNT ARM
VA6116 (Modern), VA6165 (Classical)
Slipfits over 4" round straight pole, or 4" O.D. by 6" tall round tenon.
Weight: 30 lbs. E.P.A: 1.44

MOUNTING ACCESSORIES

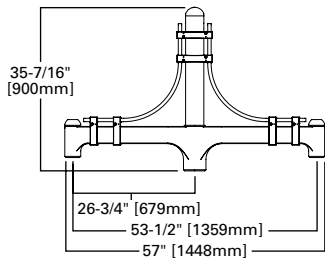

TRADITIONAL TWIN POLE MOUNT ARM WITH ROUNDED UPPER BARS
 VA6117 (Modern), VA6166 (Classical)
 Slipfits over 4" round straight pole, or 4" O.D. by 6" tall round tenon.
 Weight: 43 lbs. E.P.A.: 2.28

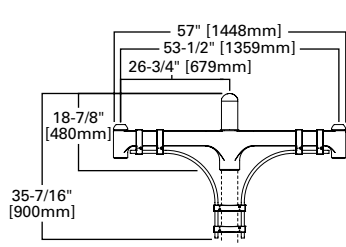

TRADITIONAL TWIN POLE MOUNT ARM WITH ROUNDED LOWER BARS
 VA6118 (Modern), VA6167 (Classical)
 Slipfits over 4" round straight pole, or 4" O.D. by 6" tall round tenon.
 Weight: 40 lbs. E.P.A.: 2.04

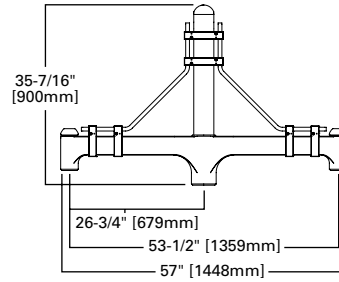

TRADITIONAL TWIN POLE MOUNT ARM WITH 45° UPPER BARS
 VA6119 (Modern), VA6168 (Classical)
 Slipfits over 4" round straight pole, or 4" O.D. by 6" tall round tenon.
 Weight: 43 lbs. E.P.A.: 2.24

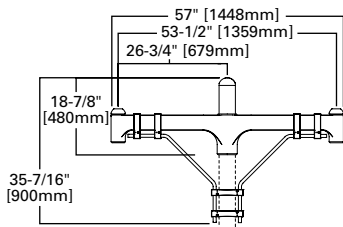

TRADITIONAL TWIN POLE MOUNT ARM WITH 45° LOWER BARS
 VA6120 (Modern), VA6169 (Classical)
 Slipfits over 4" round straight pole, or 4" O.D. by 6" tall round tenon.
 Weight: 40 lbs. E.P.A.: 2.0

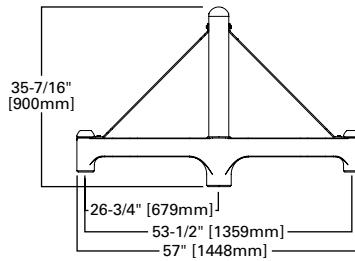

TRADITIONAL TWIN POLE MOUNT ARM WITH 45° UPPER STRAPS
 VA6121 (Modern), VA6170 (Classical)
 Slipfits over 4" round straight pole, or 4" O.D. by 6" tall round tenon.
 Weight: 37 lbs. E.P.A.: 1.81

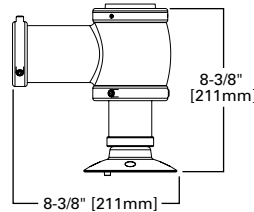

MAST ARM ADAPTER
 VA6122 (Modern), VA6171 (Classical)
 Secures fixture to nominal 2" pipe (2-3/8" horizontal O.D.)
 Weight: 4 lbs.

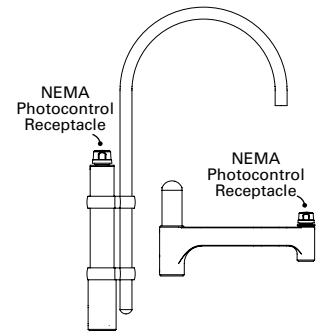

NEMA TWISTLOCK PHOTOCONTROL (R)
 Order separately (Not compatible with finials or wall mount bishop arms)

Wall Mount Accessories

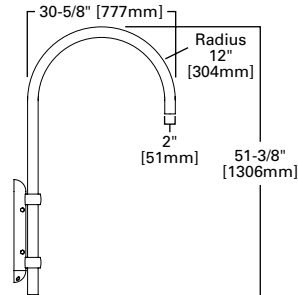

BISHOP WALL MOUNT ARM
 VA6101 (Modern), VA6150 (Classical)
 Mounts to wall with four stainless steel lag bolts (provided by other).
 Weight: 16 lbs.

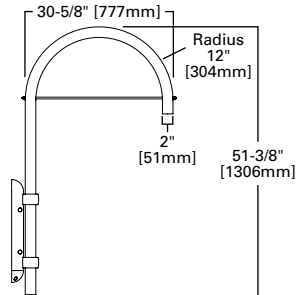

BISHOP WALL MOUNT ARM WITH CROSS ROD
 VA6102 (Modern), VA6151 (Classical)
 Mounts to wall with four stainless steel lag bolts (provided by other).
 Weight: 17 lbs.

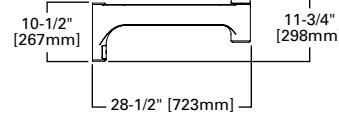

TRADITIONAL WALL MOUNT ARM
 VA6103 (Modern), VA6152 (Classical)
 Mounts to wall with four stainless steel lag bolts (provided by other).
 Weight: 17 lbs.

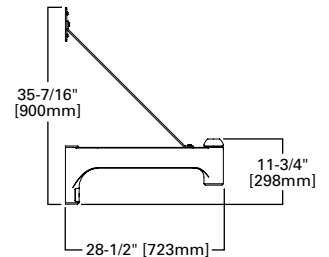

TRADITIONAL WALL MOUNT ARM WITH 45° STRAP
 VA6104 (Modern), VA6153 (Classical)
 Mounts to wall with four stainless steel lag bolts (provided by other).
 Weight: 18 lbs.