

## DESCRIPTION

The INDEX by Neo-Ray brings the power of Wavestream to limitless applications with a suspended direct indirect LED luminaire marking the beginning of a new era now unconfined by linear fluorescent lamps. By utilizing standard or custom spacing, the precision optical panels can be placed exactly where they are most effective, dramatically reducing power consumption while simultaneously improving the overall quality of the space. The Neo-Ray Index is shipped with standard 0-10V dimming drivers, but is specifiable with integral FifthLight DALI, integral emergency battery packs, and daylight/occupancy sensors. Available in 2', 4', 6', 8', 12' individual lengths and continuous runs, the Index can be suspended throughout a corridor, conference room or entire open office.

## SPECIFICATION FEATURES

### Construction

Extruded 6063 aluminum channel housing. Optical panels constructed from 6063 extruded aluminum and die-cast endcaps.

### Optics

Precision formed optical assembly with optical grade acrylic lenses providing a directed optical distribution using WaveStream technology.

### Controls

Fixtures equipped standard with 0-10V continuous dimming drivers compatible with most standard 0-10V control/dimmers. Dimming range is 5% to 100%; varies by control

device. Combine with energy-saving products like occupancy sensors, daylighting controls, and lighting relay panels from Cooper Lighting Solutions ([www.cooperlighting.com](http://www.cooperlighting.com)) to maximize energy savings.

### Electrical

Long-life LED system coupled with electrical driver to deliver optimal performance. LED's available in 3000K, 3500K or 4000K with a typical CRI ≤ 82. Projected life is 60,000 hours at 82% lumen output. Electronic drivers are available for 120-277V applications.

### Finish

Fixture housings are finished in standard white or silver using electrostatically applied polyester powder coat paint.

### Mounting

Pendant with adjustable single cable and circular canopy. Standard length of cable provided is 48".

**SCJB** = Single Cable – Junction Box  
**SCETG** = SC on 16/15" T-Grid  
**SCSTG** = SC on 9/16" Slot T-Grid  
**SCFTG** = SC on 9/16" Fine T-Grid  
**SCSR** = SC on Sheet Rock

### Warranty

Five year warranty.



## Index 8ft Continuous

LED

Suspended  
Direct/ Indirect

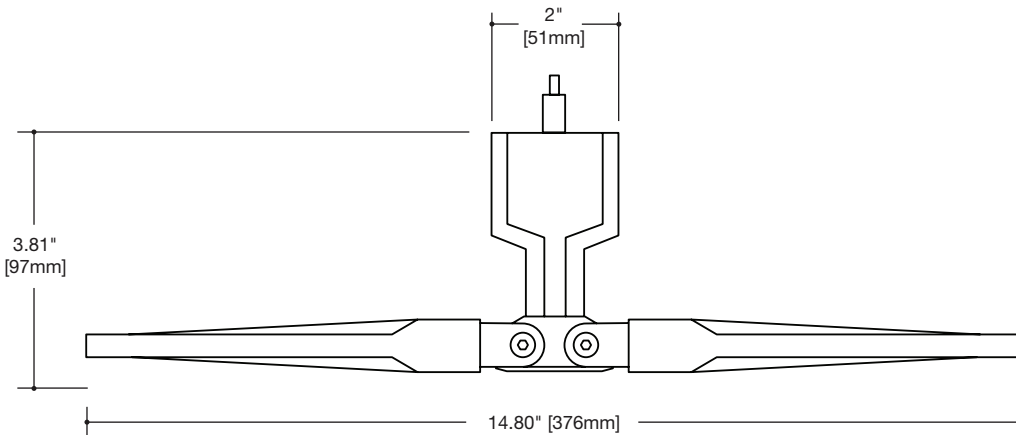

## ORDERING INFORMATION

Sample Number: 901DIP-2L35-UD0801-SCSTG-12DD-STDEM-WP20

<b>901</b>	<b>P</b>								<b>DD</b>				
<b>Series</b> 901 = Index	<b>Mounting</b> P = Pendant	<b>LED Color Temp</b> L30 = LED, 3000K L35 = LED, 3500K L40 = LED, 4000K	<b>Run Length</b> Individual Rxx = Continuous	<b>Mounting Type</b> SCJB = Single Cable SCETG = SC on ETG SCSTG = SC on STG SCFTG = SC on FTG SCSR = SC on Structure	<b>Driver</b> DD = Dimming Driver	<b>Wiring Options</b> EM = Battery Pack EC = Emergency Circuit DS = Daylight Sensor OS = Occupancy Sensor	<b>Light Output</b> DI = Direct/Indirect D = Direct	<b>Light Level</b> LED (3500K) 2ft Panel Pair 1 = Light Level 1 3136 Lumens, 32 Watts 2 = Light Level 2 4291 Lumens, 47 Watts	<b>Wing Aim</b> U = Up F = Flat D = Down	<b>Configuration Type</b> 08 = 8ft O.C. Panel Spacing	<b>Voltage</b> 1 = 120V 2 = 277V 3 = 347V U = Universal	<b>Driver Options</b> STD = 0-10V Dimming Driver 5LT = FifthLight DALI Driver LUT = Lutron DALI Driver	<b>Color Options</b> W = Matte White S = Silver
<b>NOTES:</b>													
1. Not all options available. Please consult your local Cooper Lighting Solutions Representative for availability.													
2. Specifications and dimensions subject to change without notice.													



**16-08 Configuration (2) 8ft**

**S901DIP-2L35-R16-08**  
Delivered Lumens: 12,873  
Total Input Watts: 141W  
Fixture Weight: ~59 lbs\*

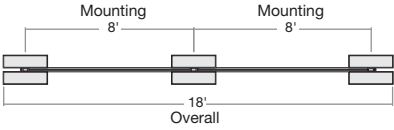

**24-08 Configuration (2) 12ft**

**S901DIP-2L35-R24-08**  
Delivered Lumens: 17,164  
Total Input Watts: 188W  
Fixture Weight: ~67 lbs\*

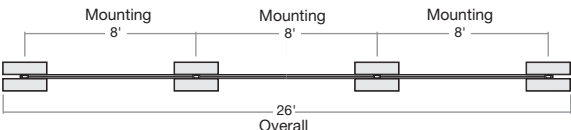

**32-08 Configuration (4) 8ft**

**S901DIP-2L35-R32-08**  
Delivered Lumens: 21,455  
Total Input Watts: 235W  
Fixture Weight: ~90 lbs\*

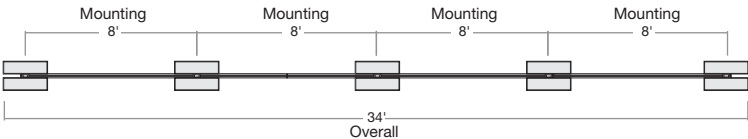

**40-08 Configuration (3) 12ft, 4ft**

**S901DIP-2L35-R40-08**  
Delivered Lumens: 25,746  
Total Input Watts: 282W  
Fixture Weight: ~113 lbs\*

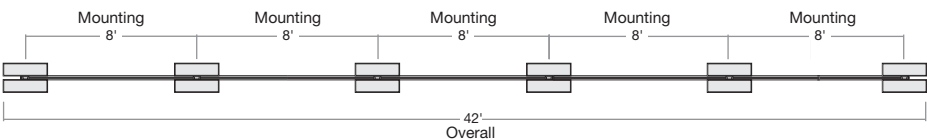

**48-08 Configuration (4) 12ft**

**S901DIP-2L35-R48-08**  
Delivered Lumens: 30,037  
Total Input Watts: 329 W  
Fixture Weight: ~121 lbs\*

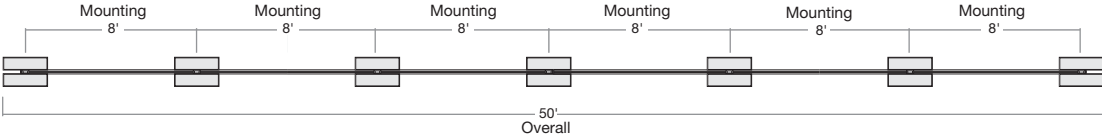

**56-08 Configuration (4) 12ft, 8ft**

**S901DIP-2L35-R56-08**  
Delivered Lumens: 34,328  
Total Input Watts: 376 W  
Fixture Weight: ~129 lbs\*

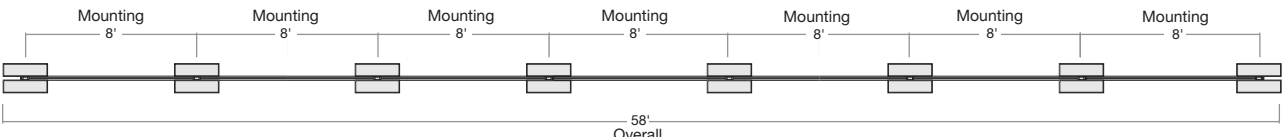

**64-08 Configuration (5) 12ft, 4ft**

**S901DIP-2L35-R64-08**  
Delivered Lumens: 38,619  
Total Input Watts: 423 W  
Fixture Weight: ~152 lbs\*

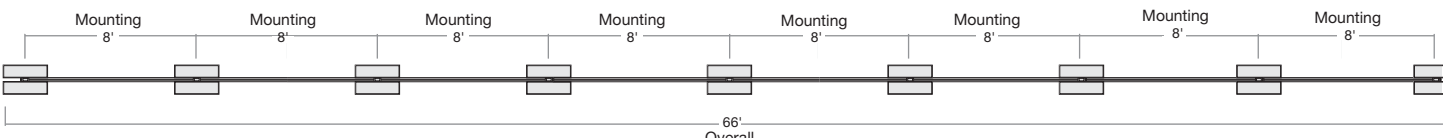

\* All weights are approximate; please consult factory drawing for exact weights and dimensions.