

DESCRIPTION

The INDEX by Neo-Ray brings the power of Wavestream to limitless applications with a suspended direct indirect LED luminaire marking the beginning of a new era now unconfined by linear fluorescent lamps. By utilizing standard or custom spacing, the precision optical panels can be placed exactly where they are most effective, dramatically reducing power consumption while simultaneously improving the overall quality of the space. The Neo-Ray Index is shipped with standard 0-10V dimming drivers, but is specifiable with integral FifthLight DALI, integral emergency battery packs, and daylight/occupancy sensors. Available in 2', 4', 6', 8', 12' individual lengths and continuous runs, the Index can be suspended throughout a corridor, conference room or entire open office.

SPECIFICATION FEATURES

Construction

Extruded 6063 aluminum channel housing. Optical panels constructed from 6063 extruded aluminum and die-cast endcaps.

Optics

Precision formed optical assembly with optical grade acrylic lenses providing a directed optical distribution using WaveStream technology.

Controls

Fixtures equipped standard with 0-10V continuous dimming drivers compatible with most standard 0-10V control/dimmers. Dimming range is 5% to 100%; varies by control

device. Combine with energy-saving products like occupancy sensors, daylighting controls, and lighting relay panels from Cooper Lighting Solutions (www.cooperlighting.com) to maximize energy savings.

Electrical

Long-life LED system coupled with electrical driver to deliver optimal performance. LED's available in 3000K, 3500K or 4000K with a typical CRI ≤ 82. Projected life is 60,000 hours at 82% lumen output. Electronic drivers are available for 120-277V applications.

Finish

Fixture housings are finished in standard white or silver using electrostatically applied polyester powder coat paint.

Mounting

Pendant with adjustable single cable and circular canopy. Standard length of cable provided is 48".

SCJB = Single Cable – Junction Box
SCETG = SC on 16/15" T-Grid
SCSTG = SC on 9/16" Slot T-Grid
SCFTG = SC on 9/16" Fine T-Grid
SCSR = SC on Sheet Rock

Warranty

Five year warranty.



Index 4ft Continuous

LED

Suspended
Direct/ Indirect

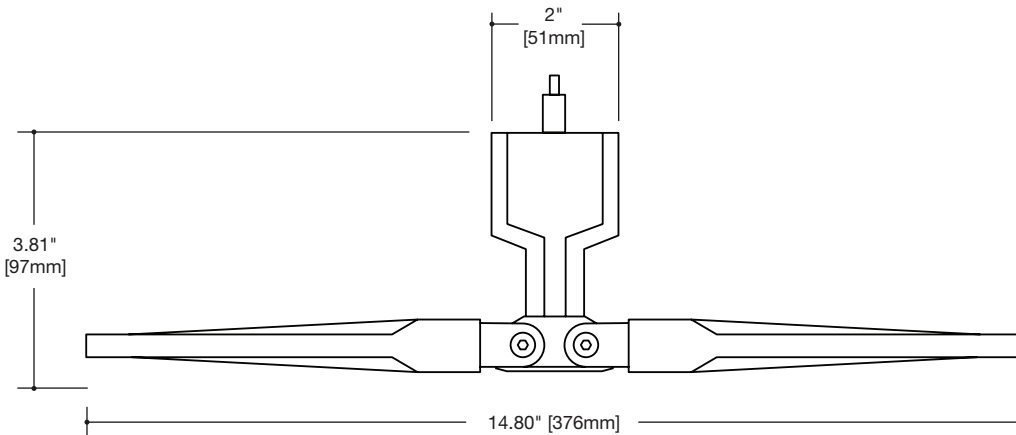

ORDERING INFORMATION

Sample Number: 901DIP-2L35-UR1004-SCSTG-12DD-5LTEC-WP20

901	P							DD				
Series 901 = Index	Mounting P = Pendant	LED Color Temp L30 = LED, 3000K L35 = LED, 3500K L40 = LED, 4000K	Run Length Individual Rxx = Continuous	Mounting Type SCJB = Single Cable SCETG = SC on ETG SCSTG = SC on STG SCFTG = SC on FTG SCSR = SC on Structure	Driver DD = Dimming Driver	Wiring Options EM = Battery Pack EC = Emergency Circuit DS = Daylight Sensor OS = Occupancy Sensor	Light Output DI = Direct/Indirect D = Direct	Light Level LED (3500K) 2ft Panel Pair 1 = Light Level 1 3136 Lumens, 32 Watts 2 = Light Level 2 4291 Lumens, 47 Watts	Wing Aim U = Up F = Flat D = Down	Configuration Type 04 = 4ft O.C. Panel Spacing	Driver Options STD = 0-10V Dimming Driver 5LT = FifthLight DALI Driver LUT = Lutron DALI Driver	Color Options W = Matte White S = Silver
											Options PXX = Perf Perc. UP	

NOTES:

1. Not all options available. Please consult your local Cooper Lighting Solutions Representative for availability.
 2. Specifications and dimensions subject to change without notice.

S901DIP-2L35-D02XXD

Lamp: (84) 3500K LEDS
 Input Watts: 47.08
 Efficacy: 89.7 Lm/W
 Mounting: HORIZONTAL

Test Report: P24119

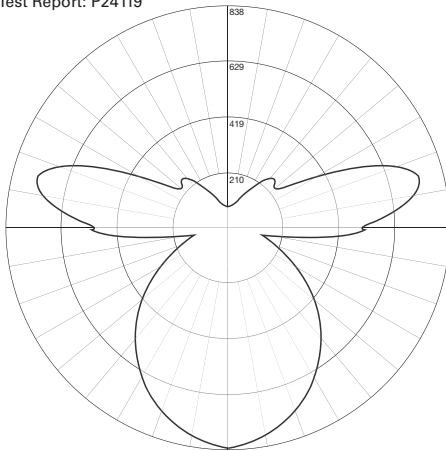

Coefficients of Utilization

Effective floor cavity reflectance 0.20

rc	80%				70%				50%				30%				10%				0%
	rw	70	50	30	10	70	50	30	10	50	30	10	50	30	10	50	30	10	0		
RCR																					
0	110	110	110	110	103	103	103	103	89	89	89	77	77	77	66	66	66	61			
1	99	93	89	85	92	87	83	80	76	73	70	66	63	61	56	54	53	48			
2	89	81	74	68	83	76	70	65	66	61	57	57	53	50	49	46	44	39			
3	81	71	63	57	76	67	59	54	58	52	48	50	46	42	43	40	37	33			
4	74	63	54	48	69	59	51	45	52	45	41	45	40	36	38	35	32	28			
5	68	56	47	41	63	52	45	39	46	40	35	40	35	31	34	31	27	24			
6	63	50	42	35	58	47	39	34	41	35	30	36	31	27	31	27	24	21			
7	58	45	37	31	54	43	35	30	38	31	27	33	28	24	28	24	21	19			
8	54	41	33	27	50	39	31	26	34	28	24	30	25	21	26	22	19	17			
9	50	38	30	24	47	35	28	23	31	25	21	28	23	19	24	20	17	15			
10	47	34	27	22	44	33	26	21	29	23	19	26	21	17	22	18	16	14			

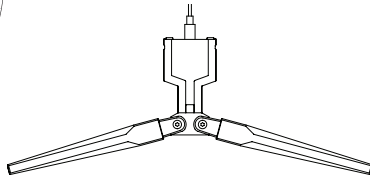

Zonal Lumen Summary

Zone	Lumens	% Fixture
0-30	649	15.4
0-40	1064	25.2
0-60	1878	44.5
0-90	2579	61.1
0-180	4223	100.0

Candela

Angle	0-Deg	45-Deg	90-Deg
0	831	831	831
5	837	826	818
15	828	799	776
25	798	740	700
35	740	656	603
45	650	547	486
55	527	417	355
65	382	282	229
75	221	154	131
85	62	166	450
90	5	172	477
95	77	218	631
105	230	273	738
115	288	268	517
125	251	273	251
135	170	228	250
145	126	166	203
155	106	116	131
165	98	93	91
175	93	85	76
180	84	84	84

S901DIP-2L35-D02XXF

Lamp: (84) 3500K LEDS
 Input Watts: 47.08
 Efficacy: 91.1 Lm/W
 Mounting: HORIZONTAL

Test Report: P24118

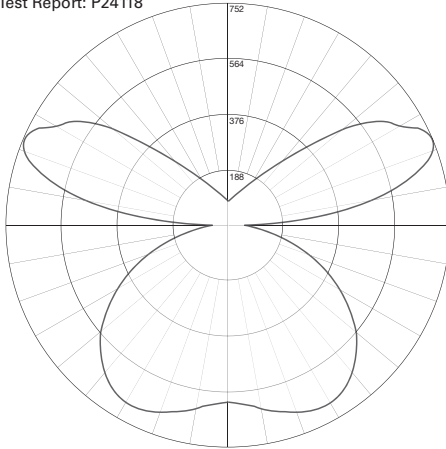

Coefficients of Utilization

Effective floor cavity reflectance 0.20

rc	80%				70%				50%				30%				10%				0%
	rw	70	50	30	10	70	50	30	10	50	30	10	50	30	10	50	30	10	0		
RCR																					
0	109	109	109	109	102	102	102	102	88	88	88	76	76	76	64	64	64	59			
1	99	94	90	86	92	88	84	80	76	73	70	65	63	61	55	54	52	47			
2	89	81	74	69	83	76	70	65	66	61	57	56	53	50	48	45	43	38			
3	81	71	63	56	75	66	59	53	57	52	47	49	45	41	41	38	36	32			
4	74	62	54	47	68	58	50	44	50	44	39	43	38	35	37	33	30	26			
5	67	55	46	40	62	51	44	38	45	38	34	38	33	30	33	29	26	22			
6	62	49	40	34	57	46	38	32	40	34	29	34	29	26	29	25	22	19			
7	57	44	36	30	53	41	34	28	36	30	25	31	26	22	27	22	19	17			
8	53	40	32	26	49	37	30	25	33	27	22	28	23	20	24	20	17	15			
9	49	36	28	23	46	34	27	22	30	24	20	26	21	17	22	18	15	13			
10	46	33	26	20	43	31	24	19	27	22	18	24	19	16	21	17	14	12			

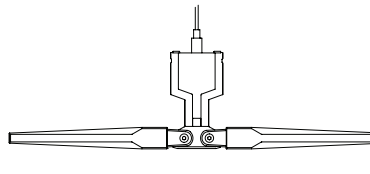

Zonal Lumen Summary

Zone	Lumens	% Fixture
0-30	538	12.5
0-40	941	21.9
0-60	1842	42.9
0-90	2523	58.8
0-180	4291	100.0

Candela

Angle	0-Deg	45-Deg	90-Deg
0	597	597	597
5	597	602	605
15	604	629	651
25	609	655	688
35	600	650	681
45	564	599	616
55	486	498	507
65	367	365	369
75	212	217	224
85	57	82	95
90	3	32	95
95	85	134	272
105	237	282	648
115	296	361	749
125	246	378	622
135	164	262	378
145	120	169	211
155	102	128	142
165	94	105	109
175	90	90	87
180	89	89	89

S901DIP-2L35-D02XXU

Lamp: (84) 3500K LEDS
 Input Watts: 47.08
 Efficacy: 89.4 Lm/W
 Mounting: HORIZONTAL

Test Report: P24120

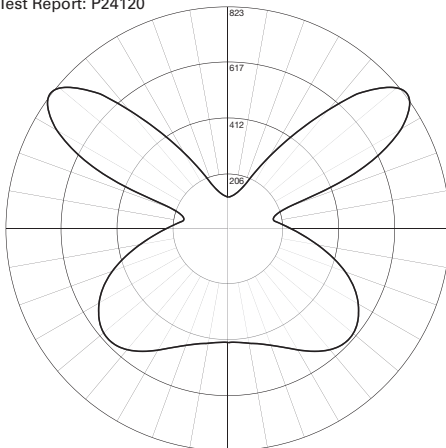

Coefficients of Utilization

Effective floor cavity reflectance 0.20

rc	80%				70%				50%				30%				10%				0%
	rw	70	50	30	10	70	50	30	10	50	30	10	50	30	10	50	30	10	0		
RCR																					
0	109	109	109	109	102	102	102	102	88	88	88	75	75	75	63	63	63	58			
1	97	92	87	82	90	85	81	77	73	70	67	62	60	58	52	50	49	44			
2	87	78	71	65	81	73	66	61	62	57	53	53	49	46	44	41	39	34			
3	79	68	59	52	73	63	55	49	54	48	43	46	41	37	38	34	31	27			
4	71	59	50	43	66	55	47	41	47	41	35	40	35	31	33	29	26	22			
5	65	52	43	36	60	48	40	34	42	35	30	35	30	26	29	25	22	18			
6	60	46	37	31	55	43	35	29	37	30	25	31	26	22	26	22	19	16			
7	55	41	33	26	51	39	31	25	33	27	22	28	23	19	24	19	16	13			
8	51	37	29	23	47	35	27	22	30	24	19	26	20	17	21	17	14	12			
9	47	34	26	20	44	32	24	19	27	21	17	23	18	15	20	15	12	10			
10	44	31	23	18	41	29	22	17	25	19	15	21	17	13	18	14	11	9			

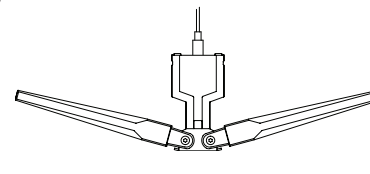

Zonal Lumen Summary

Zone	Lumens	% Fixture
0-30	383	9.1
0-40	698	16.6
0-60	1544	36.6
0-90	2444	58.0
0-180	4213	100.0

Candela

Angle	0-Deg	45-Deg	90-Deg
0	430	430	430
5	433	431	427
15	436	442	446
25	439	466	490
35	442	499	559
45	436	525	607
55	400	504	586
65	321	420	501
75	197	286	376
85	55	190	259
90	2	103	146
95	82	71	98
105	235	177	43
115	315	406	592
125	284	434	823
135	205	375	717
145	152	256	417
155	138	171	212
165	134	138	137
175	130	129	113
180	126	126	126

16-04 Configuration (2) 8ft

S901DIP-2L35-R16-04

Delivered Lumens: 1312
 Total Input Watts: 14.7
 Fixture Weight: ~79 lbs*

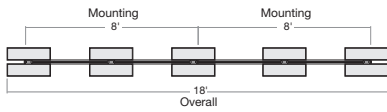

20-04 Configuration 12ft, 8ft

S901DIP-2L35-R20-04

Delivered Lumens: 1260
 Total Input Watts: 14.1
 Fixture Weight: ~95 lbs*

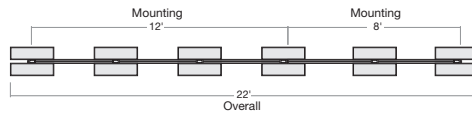

24-04 Configuration (2) 12ft

S901DIP-2L35-R24-04

Delivered Lumens: 1225
 Total Input Watts: 13.7
 Fixture Weight: ~110 lbs*

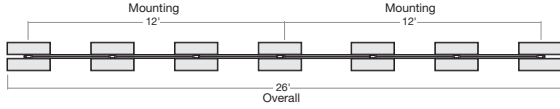

28-04 Configuration (2) 12ft, 4ft

S901DIP-2L35-R28-04

Delivered Lumens: 1200
 Total Input Watts: 13.4
 Fixture Weight: ~113 lbs*

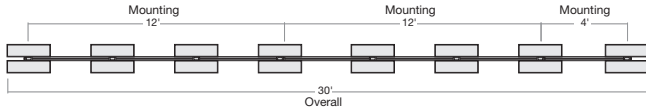

32' Configuration (4) 8ft

S901DIP-2L35-D02XXD

Delivered Lumens: 1181
 Total Input Watts: 13.2
 Fixture Weight: ~138 lbs*

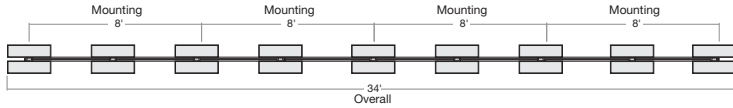

36-04 Configuration (3) 12ft

S901DIP-2L35-R36-04

Delivered Lumens: 1166
 Total Input Watts: 13
 Fixture Weight: ~154 lbs*

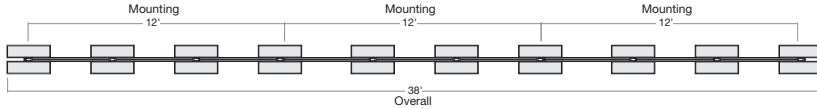

40-04 Configuration (3) 12ft, 4ft

S901DIP-2L35-R40-04

Delivered Lumens: 1155
 Total Input Watts: 13
 Fixture Weight: ~174.5 lbs*

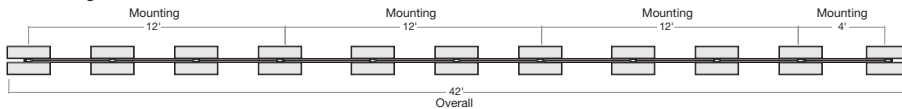

44-04 Configuration (3) 12ft, 8ft

S901DIP-2L35-R44-04

Delivered Lumens: 1145
 Total Input Watts: 12.8
 Fixture Weight: ~181.5 lbs*

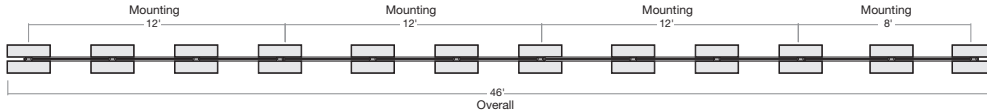

48-04 Configuration (4) 12ft

S901DIP-2L35-R48-04

Delivered Lumens: 1137
 Total Input Watts: 12.7
 Fixture Weight: ~197.5 lbs*

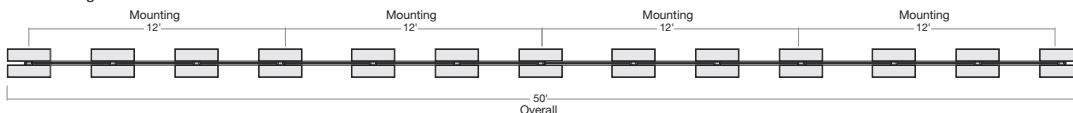

* All weights are approximate; please consult factory drawing for exact weights and dimensions.