

Project		Catalog #		Type	
Prepared by		Notes		Date	

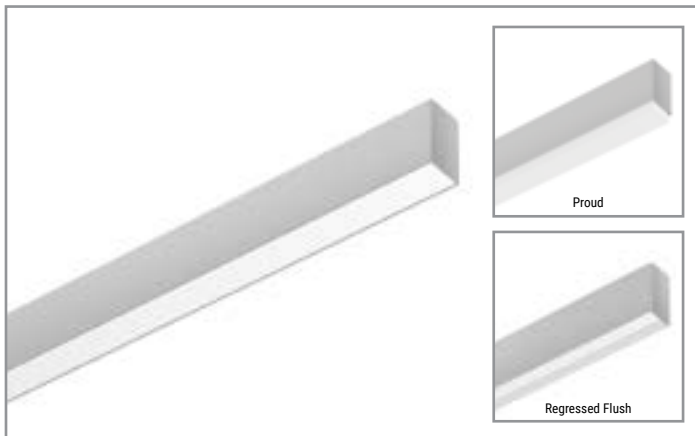

# Neo-Ray

## Define 3

3" LED  
Wall Mount  
Direct

### Typical Applications

Office • Education • Healthcare • Hospitality • Retail

### Product Certification

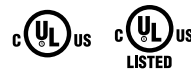

### Product Features



### Interactive Menu

- Order Information [page 2](#)
- Product Specification [page 3](#)
- Photometric Data [page 4](#)
- Performance Data [page 5](#)
- VividTune [page 6](#)

### Top Product Features

- Wall Mount Slot family in 2", 3", 4" and 5" housing sizes
- Specifiable to the nearest foot
- Satin, Asymmetric and Drop Direct Lensing available
- Independently specifiable Direct / Indirect lumen packages
- 0-10V dimming standard; DALI dimming available
- 2700K, 3000K, 3500K, 4000K, and 5000K correlated color temperatures available

### Dimensional and Mounting Details

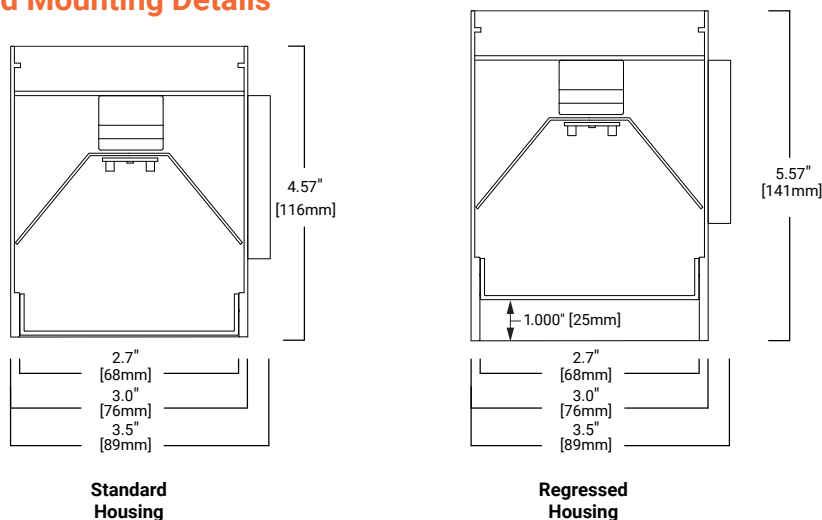

[additional product diagrams](#)

## Order Information

**Icon Key:** ∅ Consult factory for availability

SAMPLE ORDER NUMBER: **S123DW-C775D835-4F0-1E-UDD-D-W**

Series	Light Engine	Lumen Package Down (Lms/ft)	CRI	LED CCT	Luminaire Length (Ft)	Max section length	Circuiting
<b>S123DW</b> =Define 3 Direct Wall <b>S123RDW</b> =Define 3 Regressed Direct Wall	- <b>C</b> =Core - <b>H</b> =High Performance - <b>V</b> =VividTune ∅	<b>340D</b> =340 Lms/ft (2.9W/ft) <b>560D</b> =560 Lms/ft (4.8W/ft) <b>775D</b> =775 Lms/ft (6.7W/ft) <b>1000D</b> =1000 Lms/ft (8.8W/ft) <b>1165D</b> =1165 Lms/ft (10.6W) ___ <b>D</b> =Custom Lms/ft ∅	<b>8</b> =80 <b>9</b> =90	<b>27</b> =2700K <b>30</b> =3000K <b>35</b> =3500K <b>40</b> =4000K <b>50</b> =5000K <b>2765</b> =2700K-6500K <b>3050</b> =3000K-5000K	___ <b>F0</b> =Nominal Length	( <b>blank</b> )=12ft (std) /8=8ft	- <b>1</b> =Single Circuit - <b>S</b> =Secondary Circuit
<b>Notes</b> RDW regress of 1" will add an additional 1" to fixture depth.	<b>Notes</b> See performance table for add'l details. Light engine must be consistent across run length. V option requires lumen package of 775 lms/ft or greater.	<b>Notes</b> 3500K/80CRI/DIP/F Lens. Please refer to scaling data for other variables. For custom lumen output, please refer to additional information on page 3. 340 Lms/ft not available on 2ft fixture length.	<b>Notes</b> Additional lead-time and cost may apply for 927, 930, 935 and 940 configurations. 2765/3050 VividTune configurations require V light engine and W2A driver.	<b>Notes</b> Minimum fixture length is 2ft. Specify to nearest foot in length.	<b>Notes</b> Individual fixtures configured as 12ft max by default. Continuous runs configured as 8ft max (12ft not available).	<b>Notes</b> Secondary circuit similar to A/B switching. Price adder applies for "S" configuration.	

Additional Section Wiring	Voltage	Driver Type	Shielding Down
<b>E</b> =Emergency Circuit <b>B1</b> =Surelite 7W 120-277V EM battery pack (EL7W) <b>B2</b> =Surelite 14W 120-277V EM battery pack (EL14W) <b>T</b> =UL924 EPC Emergency Bypass Relay	<b>U</b> =Universal (120V-277V) <b>1</b> =120V <b>2</b> =277V <b>3</b> =347V	<b>DD</b> =Standard 0-10V Dimming (1%-100%) <b>5L</b> =Fifth Light DALI (5%-100%) <b>L5</b> =Lutron 5 Series (LDE5-Series) 5%-100% EcoSys <b>LH</b> =Lutron HiLume (LDE1 series) 1%-100% EcoSys <b>W2A</b> =White Tuning, 0-10V Dimming (VividTune only)	<b>F</b> =Satin White Diffuser <b>D</b> =Satin Drop diffuser <b>A</b> =Asymmetric Diffuser <b>C</b> =Corridor Diffuser
<b>Notes</b> Battery available on fixture ≥ 4ft in length. B1-B2 and T options not compatible with 347V. Standard battery 4ft battery section located in the beginning of the fixture, but can be relocated using the linear product configurator. When configured with secondary circuit, battery test switch will be located in a plate on the direct side of the fixture.	<b>Notes</b> 347V only available with DD driver option.	<b>Notes</b> DD driver is standard. For non-dimming applications, the driver will default to full brightness if no connection is made to the capped dimming wires in the field.	<b>Notes</b> All lensing options are snap-in lenses. "A" option is asymmetric toward the wall, "C" option is asymmetric away from the wall.

Options	Finish	Integrated Sensor
<b>R</b> =GLR Fuse (Fast) <b>F</b> =GMF Fuse (Slow)	<b>W</b> =White <b>S</b> =Silver <b>B</b> =Black <b>C</b> =Custom Match <b>R</b> =RAL Custom	- <b>WAA</b> =WaveLinX Pro Wireless - <b>WAB</b> =WaveLinX Lite Wireless ∅ - <b>LWIPD1</b> =Enlighted Wireless - <b>SVPD1</b> =Standalone ( <b>Blank</b> )=None
<b>Notes</b> Not available with 347V option	<b>Notes</b>	<b>Notes</b> DD driver must be selected. Please refer to page 5 for additional detail required to specify integrated sensors. Integral option not available with regressed or drop lensing.

## Product Specifications

### Construction

- Available in Flush and Regressed Housing
- Precision cut housing extruded from 6063 aluminum
- Precision cut & welded end-caps ensure a robust and clean construction
- Nominal 2'-12' illuminated sections used in individual fixtures and 2'-8' illuminated sections used in continuous runs

### Finish

- Electrostatically applied polyester powder coat paint

### LED Module

- Modular LED tray assembly comprising reflector and light engine with quick disconnect wire-harness for ease of installation and maintenance over the life of the luminaire

### Light Engine

- Offered with two next generation Neo-Ray light engines delivering industry leading efficacy and long-life
- LED's are available in 2700K, 3000K, 3500K, 4000K or 5000K
- CRI options of either ≥80CRI or ≥90CRI (Lumen output will be affected - please refer to the lumen adjustment factor table)

### LED Drivers

- LED system coupled with electrical driver
- Traditional electronic drivers are available for 120-277V and 347V applications

### Controls and Integrated Sensors

- Equipped standard with a 0-10V continuous dimming driver. Compatible with most standard dimming devices
- Additional control types are available (DALI & Lutron) at an additional cost
- WaveLinX and Enlighted wireless sensors as well as stand-alone sensors available

### Mounting

- Wall

### Lengths

- Available in any length (2ft min) with a resolution of 1 foot. Max section length of 12ft (8ft max used on continuous runs and available for individual fixtures)
- Additional fixture lengths are available please consult factory. All lengths are nominal and do not include end caps.

### Corners and Transition Pieces

- Corners and other transition pieces are fully luminous
- Constructed using precision mitered housing and lens components
- Extrusions are welded to ensure a precise and robust assembly
- Standard 90° horizontal corners as well as custom corners are available
- Consult online linear configurator or the factory for precise corner locations and for ordering
- Alternative transition pieces such as T's, Y's, X's, etc. are also available Ø

### Direct Snap-In lensing Options

- Satin Flush - Flush, high diffusion glare-free lens
- Satin Drop - 1" Drop, high diffusion glare-free lens
- Asymmetric - Flush, low-glare Asymmetric lens
- Flush options ship with our patent-pending underlens solution, the proud lens ships with an injection molded end cap to eliminate light leak

### Reflectors

- Precision formed cold-rolled steel reflectors with high reflectivity
- Ultra high reflectivity used with High Performance light engine

### Lumen Maintenance

- 90% (L90) of initial light output at 61,000+ hrs
- 70% (L70) of initial light output at 237,000+ hrs
- Derived from TM-21 standard @25°C for worst case operating conditions

### Custom Lumen Output

- Custom lumen output expressed option in Lumens per foot (e.g. -725D for 725 Lms/ft down). Refer to additional detail on page 4.

### Electrical

- Dimming provided as standard
- Dimming wires capped with wire-nuts for non-dimming applications
- Optional battery backup options provided
- Default battery location is internal to fixture
- Default emergency section is 4ft in length and located at the beginning of the fixture unless designated elsewhere
- Estimated lumen output = battery wattage \* min efficacy (see performance table)
- The EPC option will bypass local controls and dimming upon loss of normal power. This option is required when the fixture has both integrated sensors and emergency circuiting

### Integrated Sensors

- Please reference page 5 for details

### Weight

- 3.6 lbs per foot

### Approvals

- cULus - listed for damp locations
- Meets NYC requirements
- Meets CCEC requirements
- Tested to IESNA LM-79 and LM-80
- Can be used for State of California Title 24 high efficacy luminaire

### Warranty

- Five year warranty standard.

## Shielding Options



Standard Flush Lens



Regressed Flush Lens



Standard Proud Lens



Asymmetric Lens

## Photometric Data

 View IES files

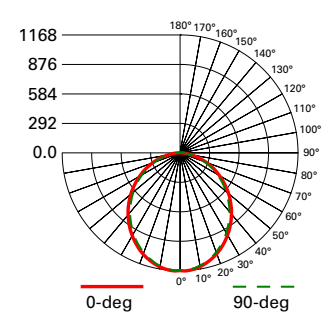
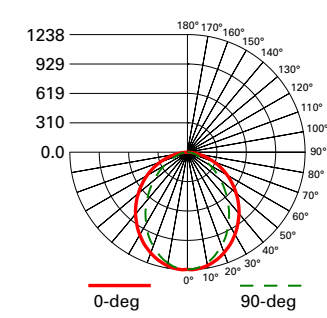
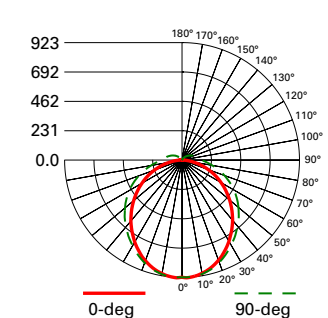
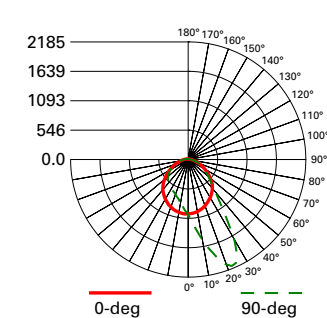
 <p><b>FILE NAME:</b> S123DR-S775D835-GYP4F0-1-UDD-F-W LUMENS: 3027 Lms LPW: 114.7 LPW CCT: 3500K WATTS: 26.4 W <b>TEST NUMBER:</b> G3-1802-639-11</p> <p>SATIN FLUSH LENS</p>	 <p><b>FILE NAME:</b> S123RDR-S775D835-GYP4F0-1-UDD-F-W LUMENS: 2786 Lms LPW: 105.5 LPW CCT: 3500K WATTS: 26.4 W <b>TEST NUMBER:</b> G3-1802-639-25</p> <p>SATIN REGRESSED DIFFUSER</p>
 <p><b>FILE NAME:</b> S123DR-S775D835-GYP4F0-1-UDD-D-W LUMENS: 3085 Lms LPW: 116.9 LPW CCT: 3500K WATTS: 26.4 W <b>TEST NUMBER:</b> G3-1802-639-15</p> <p>SATIN DROP LENS</p>	 <p><b>FILE NAME:</b> S123DR-S775D835-GYP4F0-1-UDD-A-W LUMENS: 3115 Lms LPW: 118.0 LPW CCT: 3500K WATTS: 26.4 W <b>TEST NUMBER:</b> G3-1802-639-20</p> <p>ASYMMETRIC FLUSH LENS</p>

## Photometric Overview and Performance Data

### Direct Performance Per Linear Foot at 3500K/80CRI

Nominal Output	Standard		High Performance		VividTune	
	W/ft	lm/W	W/ft	lm/W	W/ft	lm/W
340	2.9	124	2.9	126	3	120
560	4.8	125	4.4	130	4.9	121
775	6.7	122	6.1	131	6.7	119
1000	8.8	120	8.1	128	8.9	116
1165	10.6	115	9.7	123	10.7	112

### LUMEN ADJUSTMENT CALCULATIONS

**Example 1 - Adjusted Lumen Output**  
 Nominal Lumen Output selected = 1025 lms/ft (based on standard of 3500K/80CRI)  
 Lumen Adjustment Factor = 0.801 (2700K/90CRI desired)

Adjusted Lumen Output = Nominal Lumen Output x Lumen Adjustment Factor  
 Adjusted Lumen Output = 1025 lms/ft x 0.801 = 821 lms/ft

**Example 2 - Custom Lumen Output based on Required Lumens Per Foot**  
 Total light output (4ft) requirement of 2800 lms, desired CCT and CRI of 4000K/80CRI

Total required lumens per foot @ 4000K = 2800 lms / 4 ft = 700 lms/ft  
 Lumen Adjustment Factor = 1.018 (Requirement based on 4000K / 80CRI)

Total required lumens per foot @ 3500K / 80CRI = 700 lms/ft ÷ 1.018 = 688 lms/ft

Estimated efficacy = 121 LPW (find nearest value using table above)  
 Estimated power consumption = 688 lms/ft ÷ 121 lm/W = 5.69 W/ft

### Custom Lumen Output

#### Total Light Output Range (lms/ft)

CCT	Lumen Adj Factors		Direct Output Range	
	80CRI	90CRI	80CRI	90CRI
2700K	N/A	0.792	N/A	269-923
3000K	0.943	0.815	321-1099	277-949
3500K	1.000	0.861	340-1165	293-1003
4000K	1.010	0.892	343-1177	303-1039
5000K	1.010	0.892	343-1177	303-1039

If your requirement is expressed in power consumption (W/ft) rather than light output, you can use the power to lumen output curves to convert power consumption to light output for specification. Efficacy for custom lumen outputs can be estimated using lumen output curves or with the use of our online custom lumen output tool.

## Corner Transitions

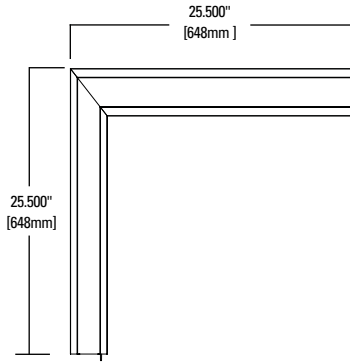

## Integrated Sensor Details and Placement

Sensor Type	Wireless	Sensor Integration	Sensor Mounting	Ordering Code
WaveLinX Pro	Yes	Integral to Fixture	Mounted in solid cover	WAA
WaveLinX Lite	Yes	Integral to Fixture	Mounted in solid cover	WAB
Enlighted	Yes	Integral to Fixture	Mounted in illuminated lens	LWIPD1
Stand-Alone SVPD1	No	Integral to Fixture	Mounted in solid cover	SVPD1

Optional standalone and wireless connected integrated sensors require use of the DD (0-10V) driver. WaveLinX and Enlighted sensors require additional system hardware (not provided) for full functionality.

Standard sensor layout is shown below. Please refer to sensor coverage pattern diagrams to ensure proper coverage for the application. Standard configurations are available in both individual fixtures and in continuous runs. Default spacing is based on the maximum fixture length of 12ft and can be changed to 8ft sensor spacing for additional coverage by selecting the 8ft max fixture length option when ordering.

For additional information integrated sensors and connected lighting, please visit [Cooper Lighting Solutions's Connected Lighting Website](#).

- Standard Sensor with Luminaire Control
- Auxiliary Sensor used for Sensor Coverage (wireless systems only)

### INTEGRAL SENSOR

≤8ft Individual

>8ft Individual

Note: When 8ft max section length is used on individual fixtures > 8ft, sensor placement follows logic for continuous run.

Beginning of Run (BOR)

Intermediate Section (INT)

End of Run (EOR) > 4ft

End of Run (EOR) ≤ 4ft



### Define 3 Pendant LED with VividTune Tunable White

VividTune tunable white luminaires deliver high-quality light in a broad range of continuously variable color temperatures and intensities. Create a dynamic environment by adjusting the ambient light warmer or cooler to influence mood, support the task at hand, or create a dramatic ambience. The ability to control correlated color temperature and intensity separately using simple controls is the next evolution of LED lighting for the commercial, educational, healthcare and hospitality space. The unparalleled flexibility and number of available lighting environments enable users to find the right light with tunable white.

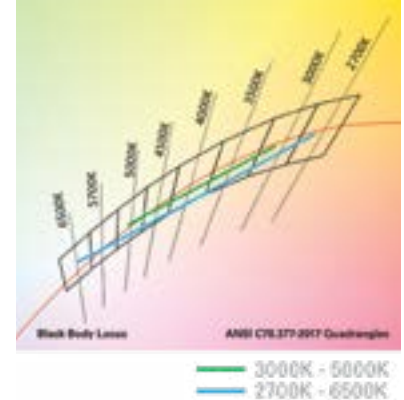

### Performance Data\*

Tunable White - Lumen Adjustment Factors				
CCT	3000K-5000K		2700K-6500K	
	80 CRI	90 CRI	80 CRI	90 CRI
2700K	-	-	0.868	0.741
3000K	0.894	0.736	0.893	0.771
3500K	0.946	0.804	0.924	0.809
4000K	0.993	0.868	0.944	0.835
4500K	1.002	0.883	0.961	0.857
5000K	1.002	0.883	0.974	0.874
6500K	-	-	0.988	0.897

Example of Approximate Lumen Calculation			
	Standard Catalog #	VividTune 80 CRI Catalog #	VividTune 90 CRI Catalog #
	S123DW-C1000D835-UDD-F-W	S123DW-V1000D83050-UW2A-F-W	S123DW-V1030D93050-UW2A-F-W
CCT Setting			
3000K	-	3576	2944
3500K	4000	3784	3216
4000K	-	3972	3472
4500K	-	4008	3532
5000K	-	4008	3532

### Controlling VividTune Tunable White

VividTune luminaires make tunable white more accessible by using simple and familiar controls. From wall dimmers to wireless controls, VividTune tunable white luminaires are compatible with industry standard 0-10V dimming controls. A single 0-10V dimming input is used to control intensity (brightness) while a second 0-10V dimming input is used to adjust CCT. For suggested control configurations, go to [www.cooperlightingsolutions.com](http://www.cooperlightingsolutions.com) for tunable white application guides.

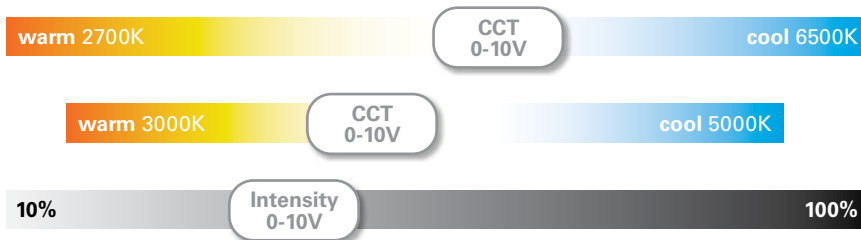

### Example of Lumen Adjustment Calculation

S123DW-V1000D83050-UW2A-F-W at 80 CRI tuned to 3500K

Adjusted Lumen = published lm x adjusted lm factor

Adjusted Lumen = 4000 x 0.946

Adjusted Lumen = 3784 lm

\* Lumen adjustment factors are for reference and may be different for each product selected. Refer to IES files for actual performance data on each.