

# INSTALLATION INSTRUCTIONS

PRODUCT: WARRIOR  
FLOODLIGHT  
IMI-216 SH.1

**IMPORTANT: READ CAREFULLY BEFORE INSTALLING FIXTURE. RETAIN FOR FUTURE REF**  
**GENERAL:** UPON RECEIPT OF FIXTURE THOROUGHLY INSPECT FOR ANY FREIGHT DAMAGE, WHICH SHOULD BE BROUGHT TO THE ATTENTION OF THE DELIVERING CARRIER. COMPARE THE CATALOG DESCRIPTION LISTED ON THE PACKING SLIP WITH THE FIXTURE LABEL ON THE HOUSING TO ASSURE YOU HAVE RECEIVED THE CORRECT MERCHANDISE.  
**SAFETY:** THIS FIXTURE MUST BE WIRED IN ACCORDANCE WITH THE NATIONAL ELECTRICAL CODE AND APPLICABLE LOCAL CODES AND ORDINANCES. PROPER GROUNDING IS REQUIRED TO INSURE PERSONAL SAFETY. CAREFULLY OBSERVE GROUNDING PROCEDURE UNDER INSTALLATION SECTION. ALL WORK SHOULD BE DONE BY A QUALIFIED ELECTRICIAN.

**WARNING:** Make certain power is OFF before starting installation or attempting any maintenance.

## TRUNNION MOUNT

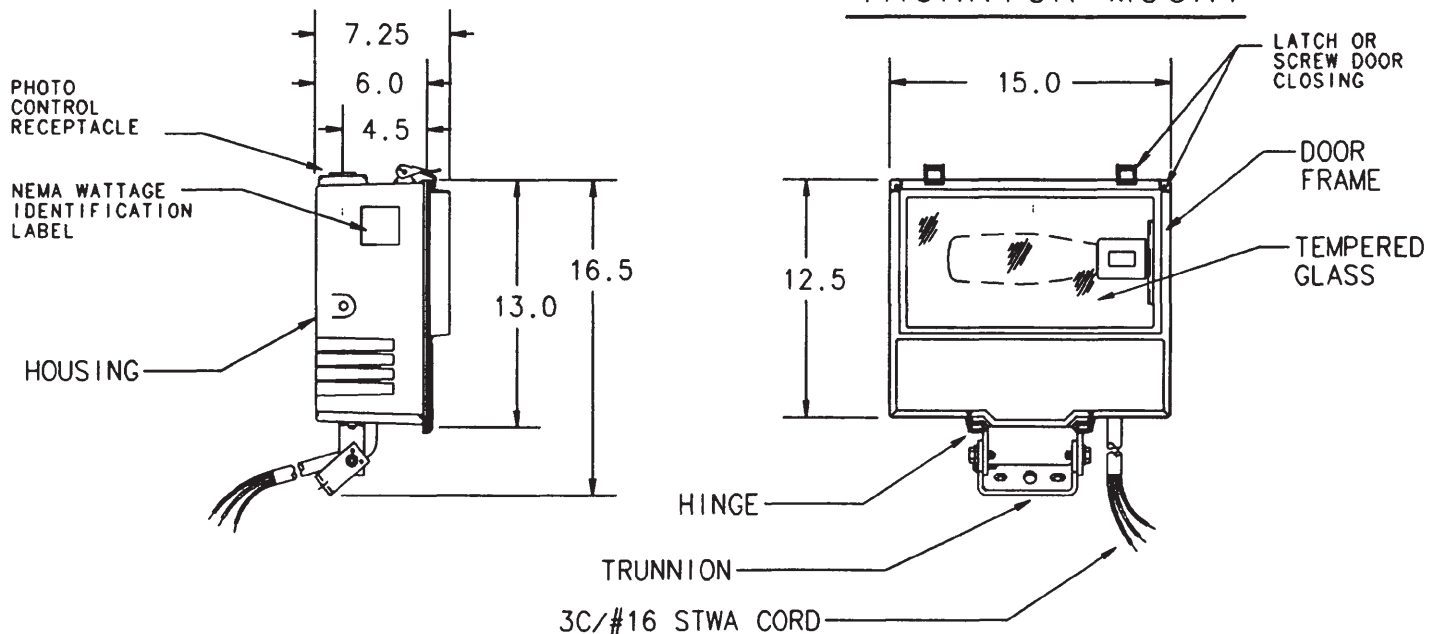

## SLIPFITTER MOUNT

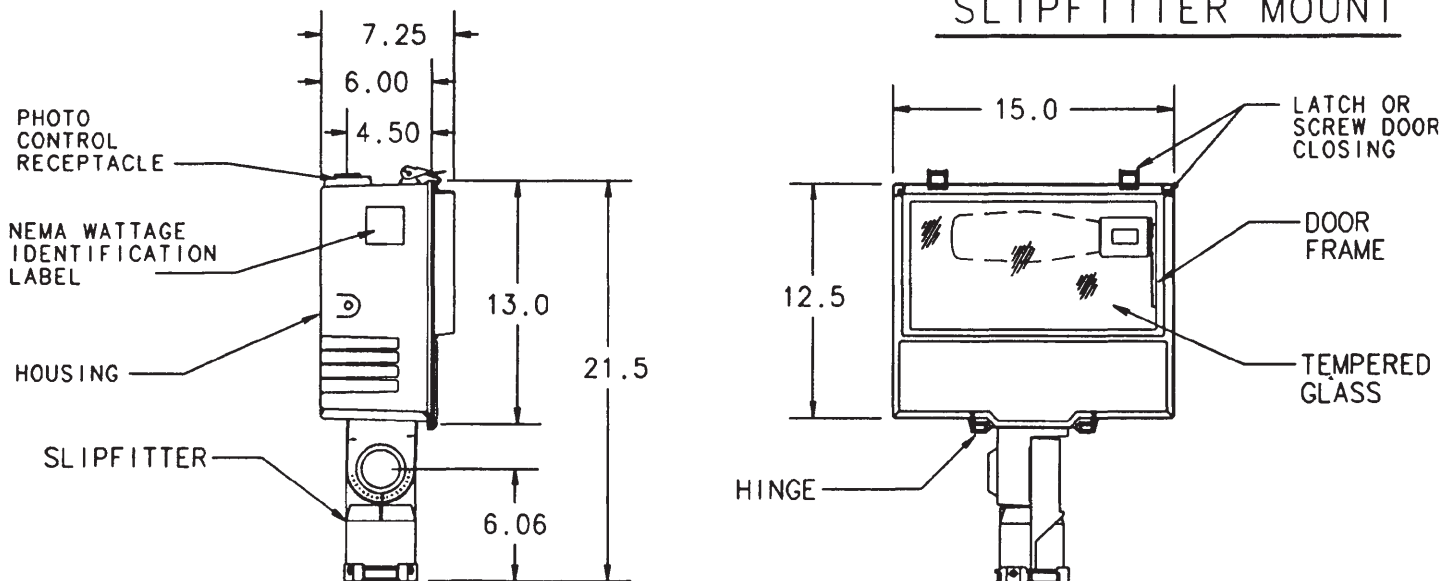

THESE INSTRUCTIONS DO NOT CLAIM TO COVER ALL DETAILS OR VARIATIONS IN THE EQUIPMENT, PROCEDURE, OR PROCESS DESCRIBED, NOR TO PROVIDE DIRECTIONS FOR MEETING EVERY POSSIBLE CONTINGENCY DURING INSTALLATION, OPERATION OR MAINTANCE. WHEN ADDITIONAL INFORMATION IS DESIRED TO SATISFY A PROBLEM NOT COVERED SUFFICIENTLY FOR USER'S PURPOSE, PLEASE CONTACT YOUR NEAREST REPRESENTATIVE.

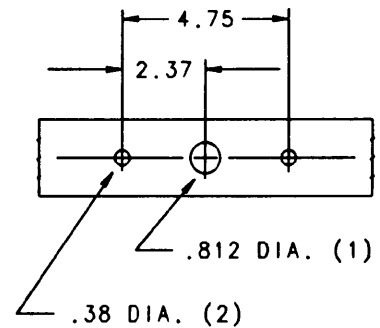
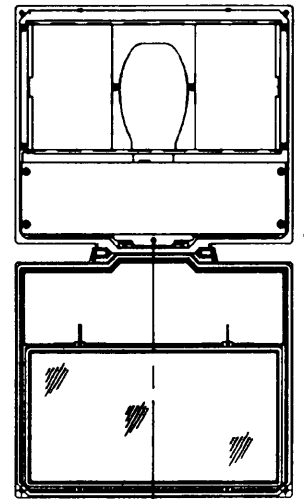
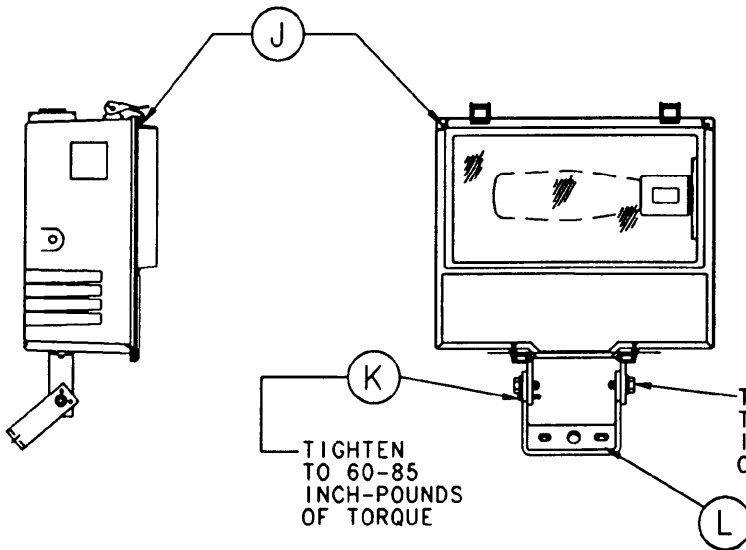
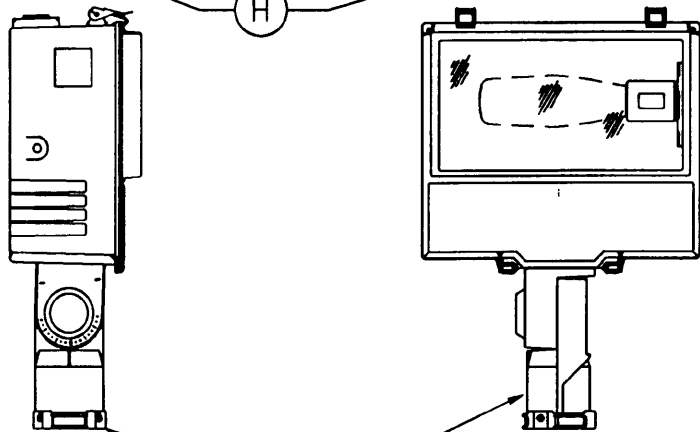
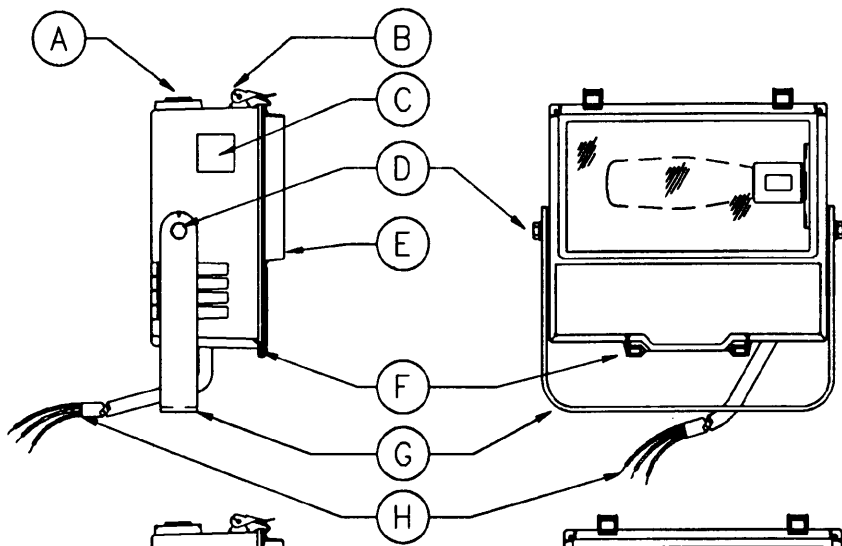

YOKE MOUNTING HOLES

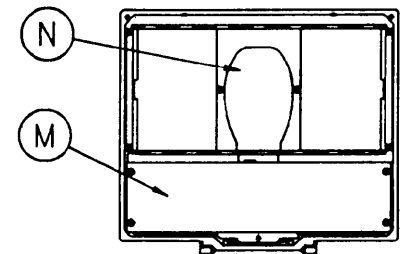

VERTICAL LAMP/  
POWER DRAWER  
ASSEMBLY

A. PHOTOELECTRIC CONTROL RECEPTACLE.  
 B. LATCHES.  
 C. NEMA WATTAGE IDENTIFICATION LABEL.  
 D. YOKE BOLTS.  
 E. LENS FRAME.

F. HINGES.  
 G. MOUNTING YOKE.  
 H. POWER CORD.  
 I. SLIPFITTER  
 J. LATCH SCREW

K. TRUNNION  
 LOCKING SCREW  
 L. TRUNNION  
 M. POWER DRAWER  
 N. VERTICAL LAMP

# YOKE MOUNTING

1. MOUNT FIXTURE USING APPROPRIATE HARDWARE. (HARDWARE BY OTHERS).
2. TO SET DESIRED AIM ANGLE, LOOSEN BOTH .50-13 YOKE BOLTS (D) AND SET AIM ANGLE. TIGHTEN YOKE BOLTS AND TORQUE TO  $45 \pm 5$  FOOT-POUNDS.
3. CONNECT POWER CORD (H) FROM FIXTURE FOLLOWING PROCEDURES THAT COMPLY WITH ALL APPLICABLE CODES.  
NOTE: ALLOW ENOUGH WIRE SLACK SO THAT FIXTURE MAY BE ROTATED THROUGH IT'S COMPLETE RANGE AND TO PROVIDE A DRIP LOOP.
4. RELEASE LATCHES (B) OR LATCH SCREWS (J) AND OPEN LENS FRAME (E).
5. FIXTURES SUPPLIED WITH MULTI-TAP BALLASTS ARE FACTORY WIRED FOR 277 VOLTS. TO CHANGE FACTORY WIRED SUPPLY VOLTAGE, REMOVE BALLAST SUPPLY WIRE FROM 277V<sub>1</sub> TERMINAL AND INSERT ON TERMINAL OF OPERATING VOLTAGE DESIRED.

CAUTION: PHOTOCONTROL MUST BE RATED FOR REWIRED VOLTAGE.

6. INSTALL HID LAMP. MAKE CERTAIN LAMP MATCHES LAMP LABEL. MAKE SURE LAMP IS SCREWED IN TIGHT.
7. CLOSE LENS FRAME (E) AND SECURE WITH LATCHES (B) OR LATCH SCREWS (J).
8. FOR PROPER ORIENTATION OF PHOTOELECTRIC CONTROL RECEPTACLE (A) LOOSEN TWO SCREWS ON PHOTOELECTRIC CONTROL RECEPTACLE. ROTATE RECEPTACLE UNTIL 'N' ON RECEPTACLE FACES NORTH. TIGHTEN RECEPTACLE SCREWS AND INSTALL PHOTOCONTROL (NOT INCLUDED).
9. ENERGIZE POWER CIRCUITS.

# SLIPFITTER POLE MOUNTING

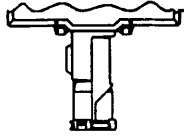

1. FIXTURE SUPPLIED WITH SLIPFITTER, HOUSING HALF ONLY. ASSEMBLE TENON HALF PER INSTRUCTION SUPPLIED WITH FITTER.

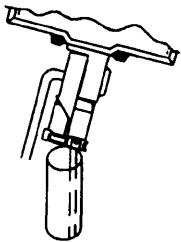

2. FEED POWER SOURCE LEADS FROM TENON UP THROUGH SLIPFITTER AND OUT WIRING CHAMBER OPENING, WHILE PLACING FLOODLIGHT OVER THEM.

## CAUTION

USE CARE TO PREVENT DAMAGING THESE LEADS BETWEEN TENON AND SLIPFITTER.

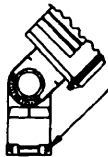

NOTE:  
SET SCREWS ON  
120° SPACING  
AROUND  
SLIPFITTER

3. AIM FLOODLIGHT INTO APPROXIMATE DIRECTION DESIRED AND TIGHTEN SLIPFITTER SET SCREWS TEMPORARILY.

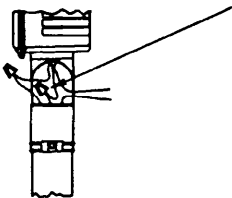

4. CONNECT FLOODLIGHT LEADS TO POWER SOURCE LEADS IN A MANNER THAT WILL COMPLY WITH REQUIREMENTS OF ALL APPLICABLE LOCAL AND NATIONAL ELECTRICAL CODES.

## WARNING

FIXTURE MUST BE PROPERLY GROUNDED TO COMPLY WITH THESE SAME ELECTRICAL CODE REQUIREMENTS FOR GROUNDING.

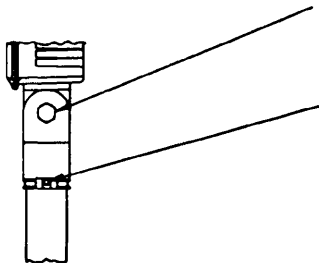

5. LOOSEN SLIPFITTER QUADRANT SCREW AND SLIPFITTER SET SCREWS ONLY ENOUGH TO ALLOW ADJUSTMENT. ADJUST ANGLE AS REQUIRED.

6. TIGHTEN SLIPFITTER QUADRANT SCREW TO 40 FT./LBS. TORQUE TIGHTEN SLIPFITTER SET SCREWS TO NOT MORE THAN 12 FT./LBS. TORQUE.

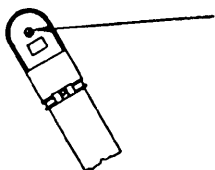

7. PUSH ALL WIRES DOWN INTO SLIPFITTER AND REPLACE WIRING CHAMBER COVER, SECURELY TIGHTENING SCREW(S).