

# Universal Source Controller

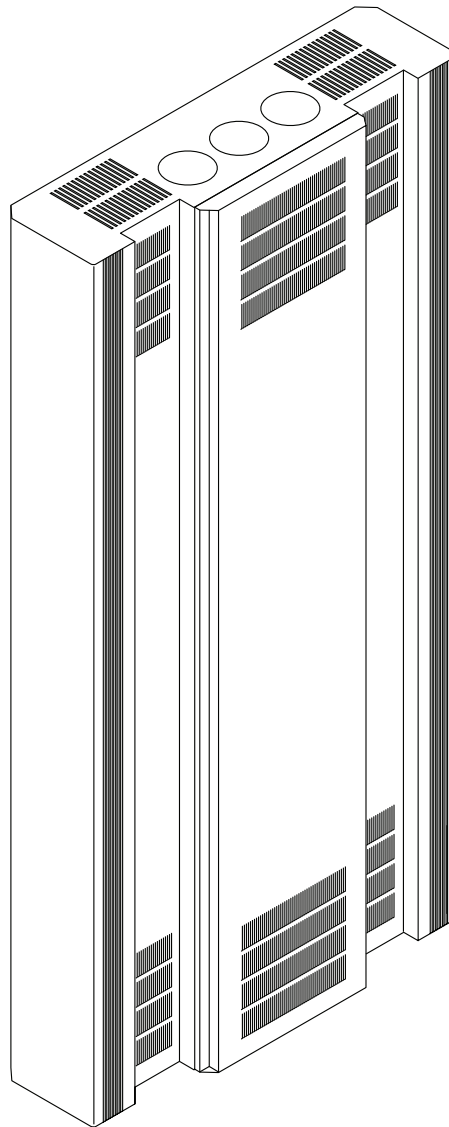

# Contents

## Contents

| <b>Description</b>                                 | <b>Page</b> |
|--|-------------|
| Introduction . . . . .                             | 3           |
| Welcome . . . . .                                  | 3           |
| Range Overview. . . . .                            | 3           |
| Cabinet Dimensions . . . . .                       | 3           |
| Specifications . . . . .                           | 5           |
| Safety . . . . .                                   | 5           |
| Please Read this First. . . . .                    | 5           |
| Important Points for Consideration . . . . .       | 5           |
| Ambient Atmosphere Requirements . . . . .          | 6           |
| Mounting . . . . .                                 | 6           |
| Location and Spacing . . . . .                     | 6           |
| Mounting Holes . . . . .                           | 7           |
| Standard Weights . . . . .                         | 7           |
| Accessing the Mounting Holes. . . . .              | 8           |
| Supply Wiring . . . . .                            | 8           |
| Wiring Flow . . . . .                              | 8           |
| Single Phase Supply. . . . .                       | 9           |
| Connecting the Supply . . . . .                    | 9           |
| Max. Wire Gauge for Input Lugs (1 Phase) . . . . . | 9           |
| Three Phase Supply . . . . .                       | 9           |
| Connecting the Supply . . . . .                    | 9           |
| Max. Wire Gauge for Input Lugs (3 Phase) . . . . . | 9           |
| Phase Distribution to Circuits . . . . .           | 10          |
| Supply to Internal Circuitry . . . . .             | 10          |
| Load Wiring . . . . .                              | 10          |
| High Voltage Load Wiring . . . . .                 | 10          |
| Total Load Per Channel . . . . .                   | 11          |
| Load Wire Gauges . . . . .                         | 11          |
| Earth Connections. . . . .                         | 11          |
| High Voltage Load Wiring Flows. . . . .            | 11          |
| Typical Load Connections . . . . .                 | 11          |
| Low Voltage Load Wiring . . . . .                  | 12          |
| Low Voltage Load Wiring Flows . . . . .            | 12          |
| Indicators. . . . .                                | 12          |
| Control Wiring . . . . .                           | 13          |
| Multiple Control Protocols . . . . .               | 13          |
| Termination . . . . .                              | 13          |
| Control Panel Operation . . . . .                  | 14          |
| Using The Control Panel. . . . .                   | 14          |
| Accessing the Operation Menu . . . . .             | 15          |
| Menu Navigation. . . . .                           | 15          |
| Overriding Channels . . . . .                      | 15          |
| Setting the Time and Date . . . . .                | 15          |
| Viewing Power Data Readings . . . . .              | 16          |
| Setting Communications Options . . . . .           | 16          |
| Changing the Operation Menu Password. . . . .      | 16          |

## Introduction

### Welcome

The iLumin Universal Source Controller range from Eaton's Cooper Controls Business has been designed to provide maximum flexibility in both installation and operation. Every model in the range can accept a variety of industry standard control options, from iCANbus to DMX, from ethernet to RS-485. Similarly, every model can drive a wide range of lighting loads, from incandescents to dimmable fluorescents, from non-dim apparatus to DALI digital modules.

Much care and attention has been applied to the installation and maintenance of the Universal Source Controllers. Each model provides clear, logical cable routing and every high voltage channel is controlled by an individual, easy to replace circuit.

### Range Overview

Each model is specified using a part number in the following format:

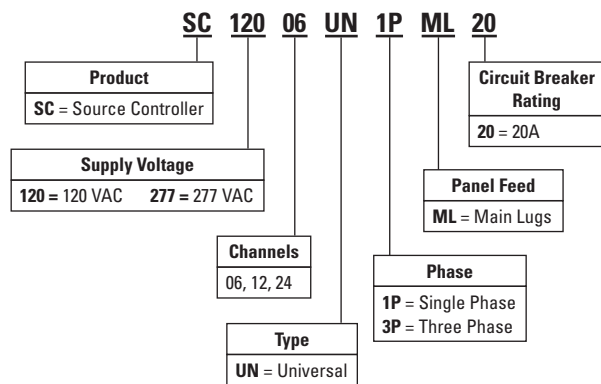

| Model Number         | Supply Voltage | Supply Type | Circuits | Feed      | Maximum Load    |
|----------------------|----------------|-------------|----------|-----------|-----------------|
| SC120-06-UN-1P-ML-20 | 120 VAC        | 1 Phase     | 6        | Main Lugs | 16A per Channel |
| SC120-12-UN-1P-ML-20 |                |             | 12       |           |                 |
| SC120-06-UN-3P-ML-20 |                | 3 Phase     | 6        |           |                 |
| SC120-12-UN-3P-ML-20 |                |             | 12       |           |                 |
| SC120-24-UN-3P-ML-20 | 277 VAC        | 1 Phase     | 24       |           |                 |
| SC277-06-UN-1P-ML-20 |                |             | 3 Phase  |           |                 |
| SC277-06-UN-3P-ML-20 |                | 12          |          |           |                 |
| SC277-12-UN-3P-ML-20 |                |             | 24       |           |                 |

## Cabinet Dimensions

Three overall cabinet sizes are available as shown on this and the following two pages.

### 6 Circuit Cabinet

#### Weight

Packed: 100 lbs (45 Kg)

Unpacked: 88 lbs (40 Kg)

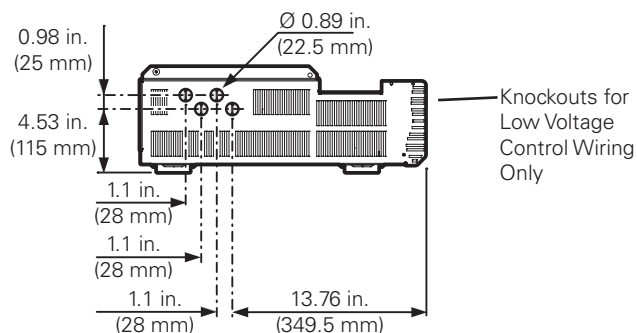
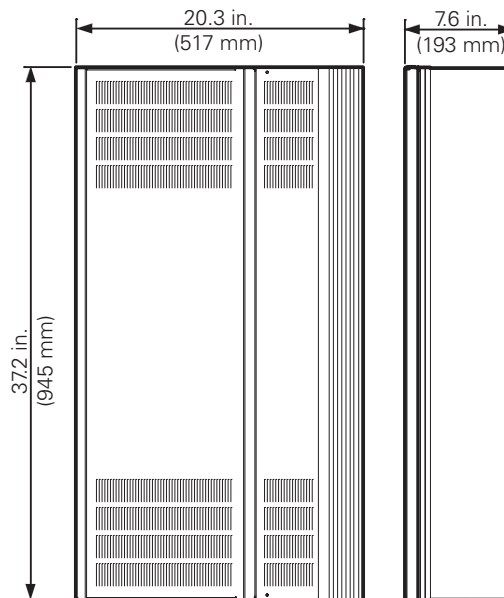
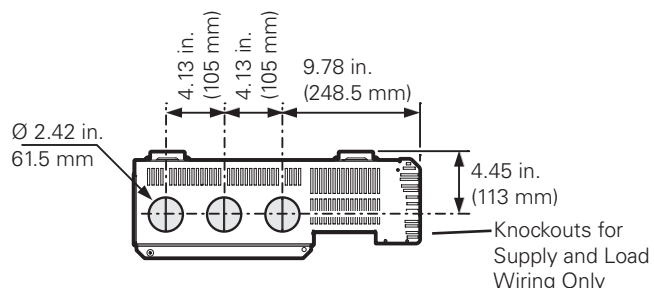

# Introduction

## 12 Circuit Cabinet

### Weight

Packed: 160 lbs (72 Kg)

Unpacked: 132 lbs (60 Kg)

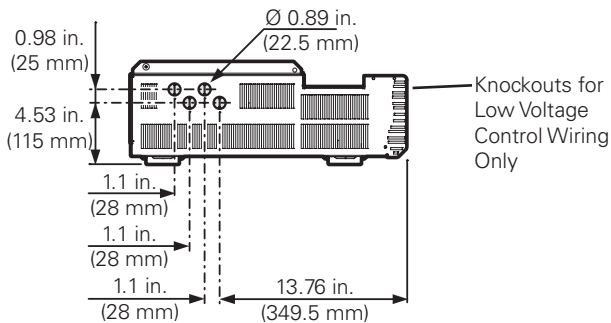
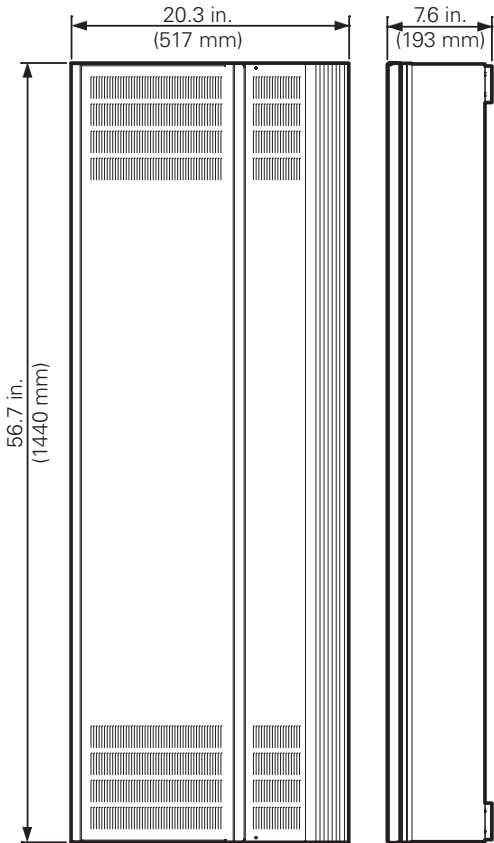
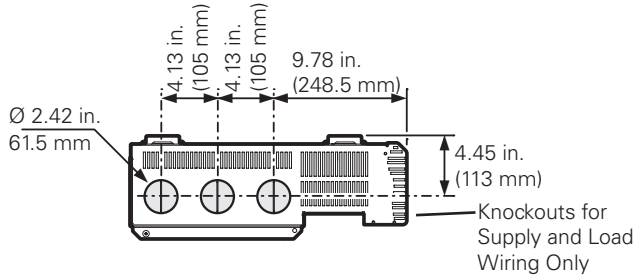

## 24 Circuit Cabinet

### Weight

Packed (24): 220 lbs (100 Kg)

Unpacked (24): 200 lbs (90 Kg)

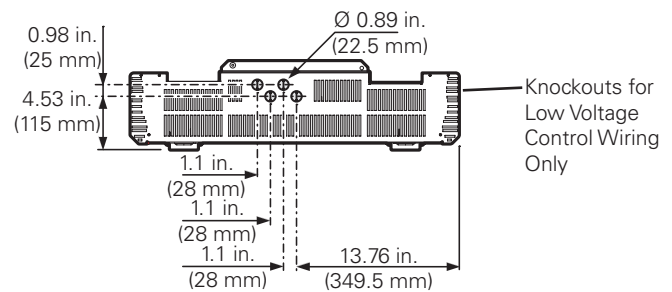
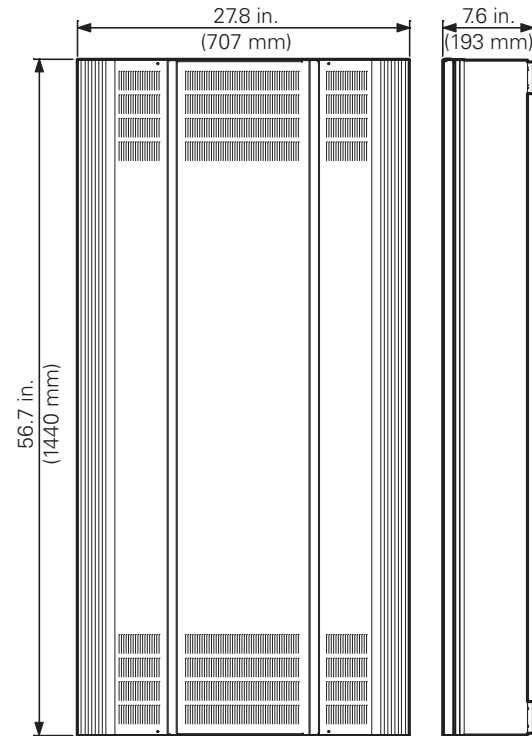
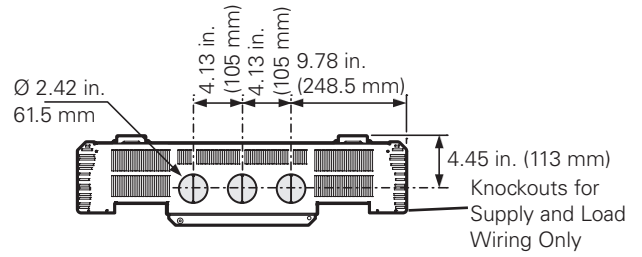

## Specifications

The numerous models within the Universal Source Controller range share the following key specifications. Information specific to each cabinet model are provided elsewhere throughout this guide.

- All channels provide switched (non-dim) and dimmed high voltage load control as standard
- Leading-edge triac dimmer engines capable of withstanding repetitive inrush currents of 50 times operating current without impacting lifetime
- All dimming and switching circuitry for every channel located on individual boards for quick and easy swap out, if necessary
- Voltage and frequency compensation to maintain light level during supply fluctuations
- All channels protected by thermal magnetic circuit breakers
- Power monitoring for each circuit, phase and the total panel
- Bypass jumpering fitted as standard to protect circuits and allow work lighting during installation
- Selectable low voltage load control available per channel for dimmable ballast control
- Low maintenance and quiet operation thanks to fanless, convection cooled operation
- Support for multiple control protocols: iCAN for links to multiple control sources; DMX512A for links with entertainment systems; RS-485 for integration with building management schemes and ethernet for connection to a variety of systems
- Dual volt-free switch inputs, with programmable responses, for integration with emergency control devices, building management systems, etc
- Compact wall mounted design with easy access to all internal items and lockable front panel door for added security
- Intuitive control panel provides straightforward programming and configuration of the system. The control panel allows a base level installation to be configured without the use of separate PC programming

## Safety

### Please Read This First

The Universal Source Controllers are designed, built and tested to strict safety regulations. By following the steps listed below and elsewhere within this guide, you can ensure safe installation and operation of these controller units.

- The Universal Source Controllers must be installed only by a qualified electrician
- The installation must comply with the appropriate electrical codes and regulations in force in your area
- The Universal Source Controllers are designed for indoor installation and use only. The units can, however, be used to control appropriately certified exterior lighting fixtures
- Ensure that all wiring used conforms fully to local specifications and is sufficiently rated for the installation
- All new wiring must be fully verified before applying power
- The high voltage supply should be fed to the Universal Source Controller via an external isolation breaker with sufficient capacity for the planned installation
- All Universal Source Controllers exceed the weight limit for one person lifting - always use at least two people when lifting and mounting the units
- Do not mix load types within a single channel (e.g. 120V tungsten and low voltage ballast control)
- Ensure that the supply is fully isolated at an external breaker before removing the chassis covers. Test that power has been removed before starting to handle conductors
- Ensure that high voltage and low voltage wiring remains separate

### Important Points For Consideration

- The Universal Source Controllers must be mounted flush with the wall, do not recess the controller chassis
- Upper and lower raceways must not be located within 8 inches (200 mm) of the upper and lower panels of the Universal Source Controller. Use suitable conduits and couplers to link the raceways to the controller chassis
- Allow adequate space for future maintenance of the unit. Do not install in a location that will later be difficult to access
- The Universal Source Controllers are designed to be mounted vertically
- During operation, the Universal Source Controllers will produce audible noise caused by electrical noise suppression circuitry and also the circuit relays within the unit. The noise is a low level buzz that varies with the level of dimming and also clicks when relays are energised. Take these matters into consideration when deciding on a suitable mounting position.

## Safety

- The hinged cover must be unscrewed and removed from the front cover when the Universal Source Controller operates at full load in a high ambient environment

### Ambient Atmosphere Requirements

Temperature 32° F to 104° F (0° C to +40° C)

Humidity 0 to 95% non-condensing

## Mounting

### Location and Spacing

The Universal Source Controller models are all fully convection cooled, therefore it is vitally important to ensure that each unit is installed in a ventilated location that permits sufficient airflow and provides the correct ambient conditions.

Ensure that the minimum distances to walls and other equipment shown in the diagrams below are maintained.

Also ensure that the stated ambient atmosphere requirements are not exceeded.

Refer to 'Important points for consideration' when choosing a mounting location.

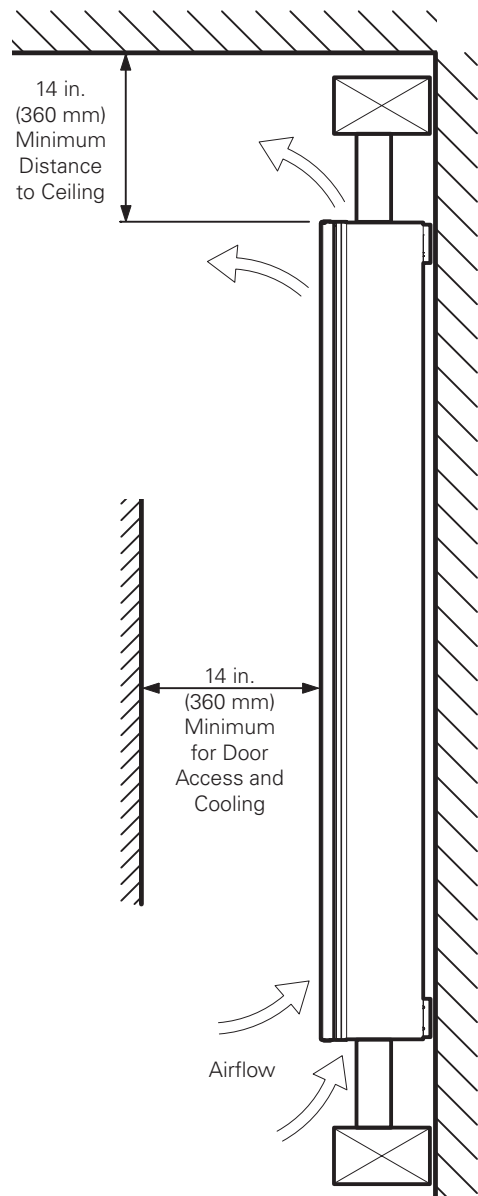
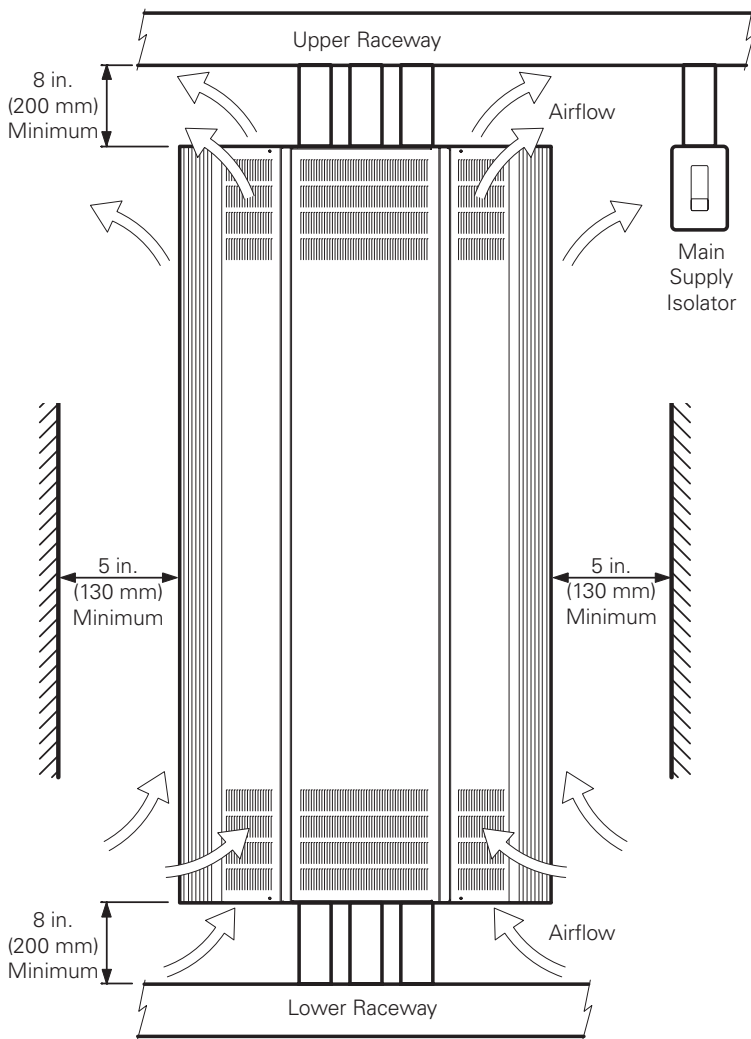

**Mounting Holes**

All models within the Universal Source Controller range are **NEMA Type 1 IP20** rated for indoor use only. Four mounting holes are provided within the rear of each chassis for attachment to a suitable wall.

Ensure that the mounting wall is able to safely support the weight of the unit plus all wiring hardware and that it complies with local codes. Reinforce where necessary.

Ensure also that the mounting bolts and fixings used are of sufficient strength and quality to safely hold the unit.

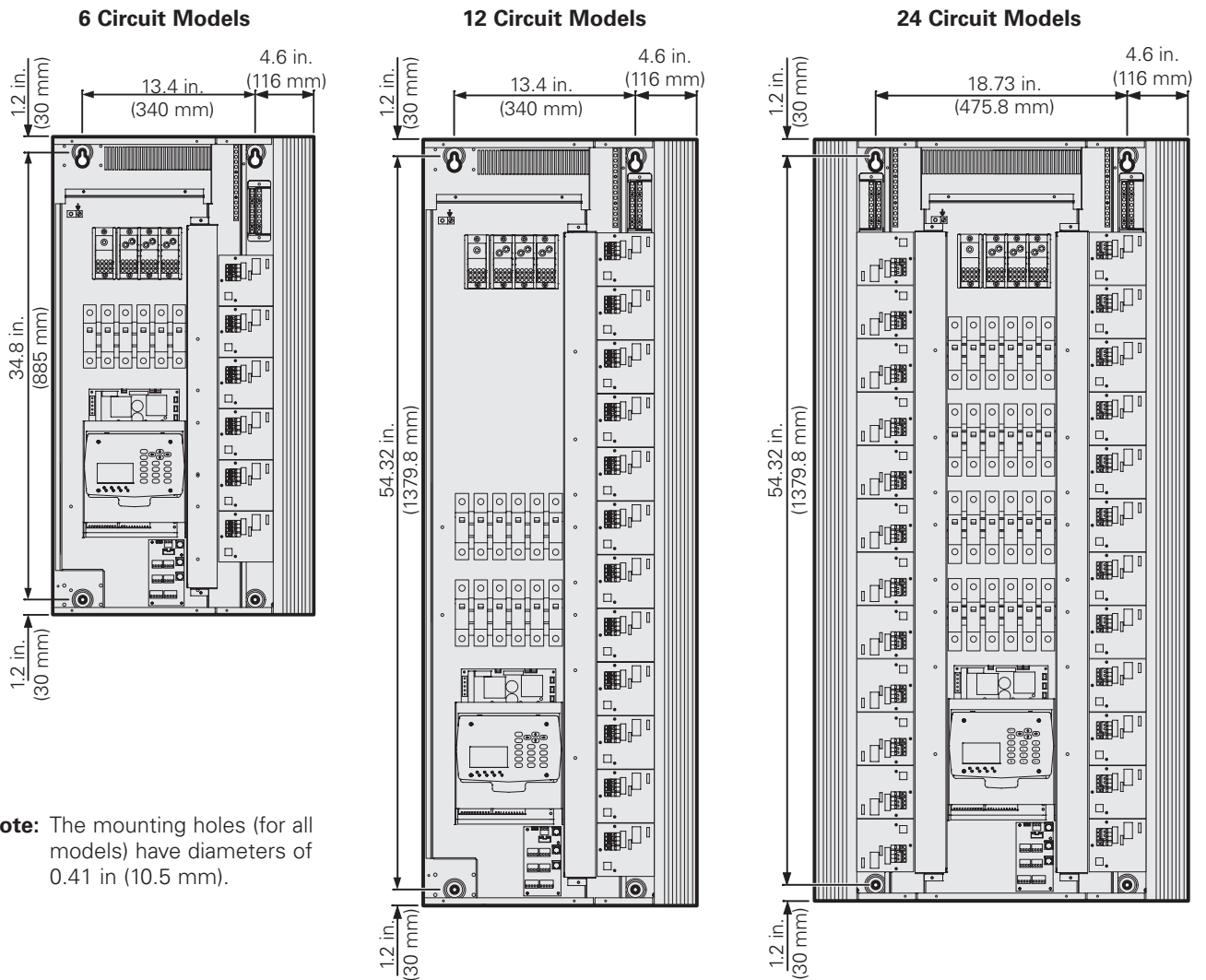

**Note:** The mounting holes (for all models) have diameters of 0.41 in. (10.5 mm).

**Standard Weights**

| Cabinet    | Unpacked Weight |
|------------|-----------------|
| 6 Circuit  | 88 lbs (40 Kg)  |
| 12 Circuit | 132 lbs (60 Kg) |
| 24 Circuit | 200 lbs (90 Kg) |

## Supply Wiring

### Accessing the Mounting Holes

The mounting holes are located within the rear panel of the Source Controller. To access the mounting holes (and circuit wiring terminals) it is necessary to remove the front panels.

### To Remove the Front Panels

**CAUTION:** If removing panels on a previously installed Source Controller, ensure that all power inputs are isolated first.

1. Open the main panel door.
2. Remove the two upper and two lower screws that hold the main panel in place and carefully lift off the complete panel.
3. Now remove the single upper and single lower screw holding the right side panel in place. Carefully lift off the panel.
4. For 24 circuit models, repeat step 3 for the left side panel.

### To Replace the Front Panels

1. Replace the side panel(s) first. Place the right side panel onto the chassis and replace the upper and lower fixing screws.
2. For 24 circuit models, repeat step 1 for the left side panel.
3. Place the main panel onto the chassis and open the door. Replace the two upper and two lower fixing screws.

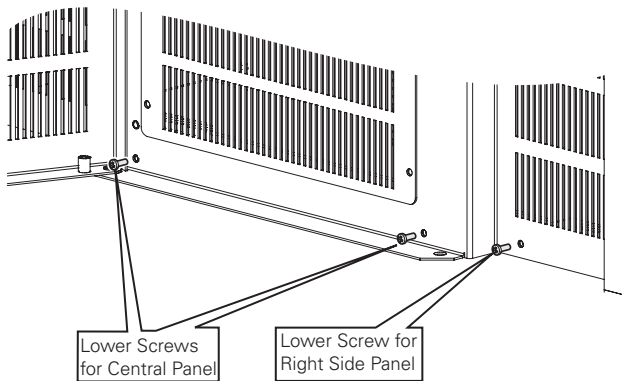

## Supply Wiring

### Wiring Flow

The Universal Source Controller range has been designed to provide a clear layout and logical progression for all power circuits.

The main supply conductors enter at the top panel and connect directly to the input lugs. Input power is then fed to a central bank of breakers and distributed from there to each of the individual circuit cards.

Two vertical wireways (one for 6 and 12 circuit models) provide clear routes from the circuit card outputs up to the earth terminals and the exit knockouts within the top panel of the chassis.

The diagram shown below indicates a typical wiring flow with the high voltage load wiring from the various channels (and their earth connections) exiting from the top panel.

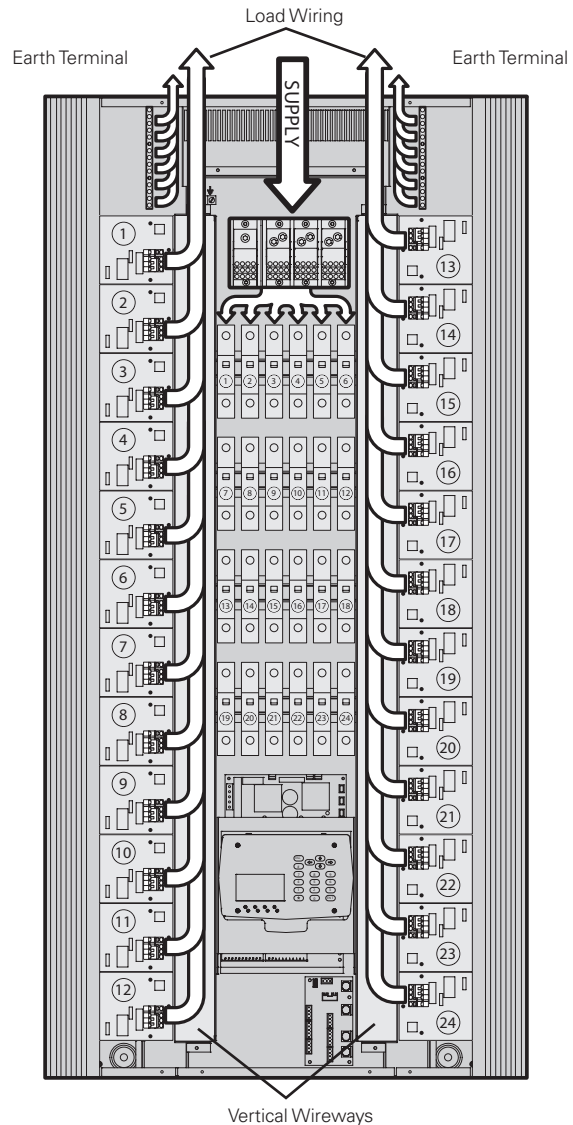



### Single Phase Supply

The Universal Source Controllers are available in single phase supply variants.

**Note:** Check the stated voltage rating of the controller before connecting to the supply and check that it matches the supply voltage.

### Connecting the Supply

The suggested entry point for the supply wiring is via the center knockout on the top panel of the chassis. This provides immediate access to the supply lugs below and also leaves the two knockouts either side for exiting load wiring. Use a suitable conduit and coupler to feed the source wiring safely into the chassis.

See the diagram below for connection details. The main earth terminal is located near to the neutral lug. The earth connection is bonded to the main backplane of the chassis and the outer panels.

Please consult the table below for details about the maximum permissible supply wire gauges for the various controller models.

Top panel knockouts: 3 x 2.42 inches (61.5 mm).

### Maximum Wire Gauge for Input Lugs (Single Phase)

The figures shown below provide the maximum wire gauges that can be used with the input lugs within each Source Controller model. The actual gauges of supply wiring that should be used in any particular installation will depend upon the connected loads, the wire type used, expected ambient temperatures and codes in force within your locality.

| Source Controller | Hot                            | Neutral                        | Earth                       |
|-------------------|--------------------------------|--------------------------------|-----------------------------|
| 6 circuit 120V    | 2/0 AWG (70 mm <sup>2</sup> )  | 2/0 AWG (70 mm <sup>2</sup> )  | 2 AWG (35 mm <sup>2</sup> ) |
| 12 circuit 120V   | 350 MCM (185 mm <sup>2</sup> ) | 350 MCM (185 mm <sup>2</sup> ) | 2 AWG (35 mm <sup>2</sup> ) |
| 6 circuit 277V    | 2/0 AWG (70 mm <sup>2</sup> )  | 2/0 AWG (70 mm <sup>2</sup> )  | 2 AWG (35 mm <sup>2</sup> ) |

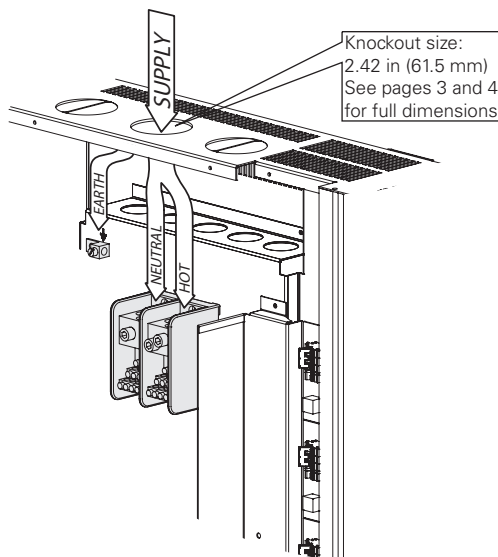

### Three Phase Supply

The Universal Source Controllers are available in three phase supply variants.

**Note:** Check the stated voltage rating of the controller before connecting to the supply and check that it matches the (phase to neutral) supply voltage.

### Connecting the Supply

The suggested entry point for the supply wiring is via the center knockout on the top panel of the chassis. This provides immediate access to the supply lugs below and also leaves the two knockouts either side for exiting load wiring. Use a suitable conduit and coupler to feed the source wiring safely into the chassis.

See the diagram below for connection details. The main earth terminal is located near to the neutral lug. The earth connection is bonded to the main backplane of the chassis and the outer panels.

Please consult the table below for details about the maximum permissible supply wire gauges for the various controller models.

Top panel knockouts: 3 x 2.42 in (61.5 mm).

### Maximum Wire Gauge For Input Lugs (Three Phase)

The figures shown below provide the maximum wire gauges that can be used with the input lugs within each Source Controller model. The actual gauges of supply wiring that should be used in any particular installation will depend upon the connected loads, the wire type used, expected ambient temperatures and codes in force within your locality.

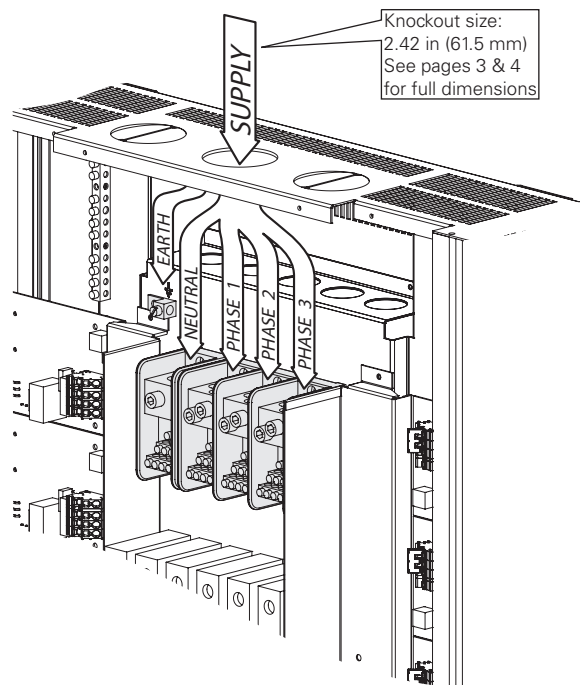

## Load Wiring

| Source Controller | Hot                            | Neutral                        | Earth                       |
|-------------------|--------------------------------|--------------------------------|-----------------------------|
| 6 circuit 120V    | 2/0 AWG (70 mm <sup>2</sup> )  | 2/0 AWG (70 mm <sup>2</sup> )  | 2 AWG (35 mm <sup>2</sup> ) |
| 12 circuit 120V   | 2/0 AWG (70 mm <sup>2</sup> )  | 2/0 AWG (70 mm <sup>2</sup> )  | 2 AWG (35 mm <sup>2</sup> ) |
| 24 circuit 120V   | 4/0 AWG (120 mm <sup>2</sup> ) | 350 MCM (185 mm <sup>2</sup> ) | 2 AWG (35 mm <sup>2</sup> ) |
| 6 circuit 277V    | 2/0 AWG (70 mm <sup>2</sup> )  | 2/0 AWG (70 mm <sup>2</sup> )  | 2 AWG (35 mm <sup>2</sup> ) |
| 12 circuit 277V   | 2/0 AWG (70 mm <sup>2</sup> )  | 2/0 AWG (70 mm <sup>2</sup> )  | 2 AWG (35 mm <sup>2</sup> ) |
| 24 circuit 277V   | 4/0 AWG (120 mm <sup>2</sup> ) | 350 MCM (185 mm <sup>2</sup> ) | 2 AWG (35 mm <sup>2</sup> ) |

### Phase Distribution to Circuits

The available circuits within each Universal Source Controller are evenly distributed between the three phases, as listed here:

| 6 Circuit Controllers  |                                      |
|------------------------|--------------------------------------|
| Phase 1:               | Circuits 1, 4                        |
| Phase 2:               | Circuits 2, 5                        |
| Phase 3:               | Circuits 3, 6                        |
| 12 Circuit Controllers |                                      |
| Phase 1:               | Circuits 1, 4, 7, 10                 |
| Phase 2:               | Circuits 2, 5, 8, 11                 |
| Phase 3:               | Circuits 3, 6, 9, 12                 |
| 24 Circuit Controllers |                                      |
| Phase 1:               | Circuits 1, 4, 7, 10, 13, 16, 19, 22 |
| Phase 2:               | Circuits 2, 5, 8, 11, 14, 17, 20, 23 |
| Phase 3:               | Circuits 3, 6, 9, 12, 15, 18, 21, 24 |

### Supply to Internal Circuitry

The internal power supply that feeds the control panel and associated circuitry can draw its power from any and all phases so that it will still operate in the event that not all supply phases are available.

## Load Wiring

### High Voltage Load Wiring

Each load channel is served by a dedicated control card fed from a designated circuit breaker. For each card, load connections are made using a four-way rapid connection block.

Available at the connection block are a permanent **Hot** (subject to circuit breaker status), **Switched hot** (via relay control), **Dimmed hot** (via triac control) and **Neutral** - see diagram below.

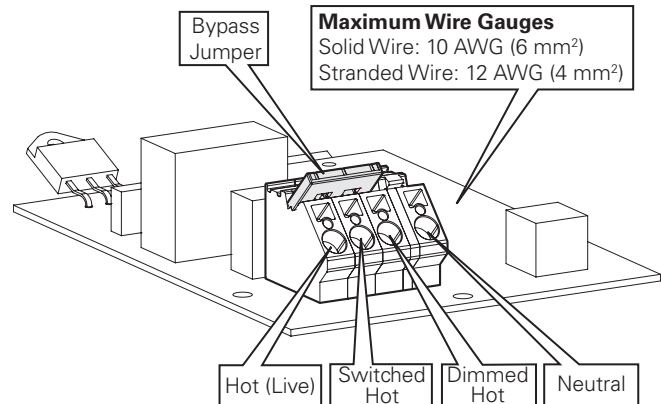

**Note:** Earth connections for each channel are made using the connector blocks located at the top of each wireway.

When supplied, a red 3-way bypass jumper is installed within each connection block to serve three purposes:

- To bind the three outputs in order to protect each channel card from load faults during installation
- To energize each channel output (subject to the status of the associated circuit breaker) for use as work lighting control during installation and
- To assist with circuit testing during commissioning

**IMPORTANT:** The bypass jumper must remain in place on each channel until the commissioning process is complete.

**Total Load Per Channel**

The load on each channel **must not exceed 16A**.

**Load Wire Gauges**

Load wiring must be sized according to the nature of the channel load(s) and with strict regard to regulations and codes in force within your locality. The maximum permissible wire gauges accepted by the connector blocks are:

- Solid wire: 10 AWG (6 mm<sup>2</sup>)
- Stranded wire: 12 AWG (4 mm<sup>2</sup>)

**Earth Connections**

Earth connections for each channel are available at the connector blocks located at the top of each wireway:

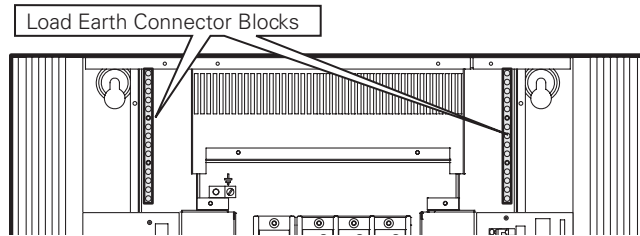

**To Insert a Wire**

1. Strip roughly a quarter inch (6 mm) of insulation from the wire end.
2. Place a small flat blade screwdriver all the way into the upper rectangular hole (keep the tip of the screwdriver against the top edge of the hole).
3. Press the screwdriver tip downwards towards the base of the connection block and push the stripped wire into the large circular hole.
4. When the wire is in place, release the screwdriver and check that the wire is firmly held by the internal spring clip.

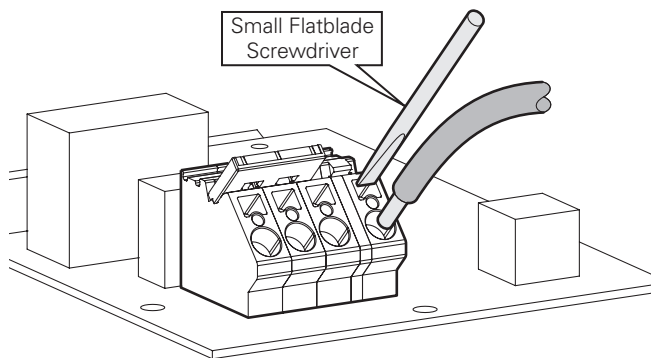

**High Voltage Load Wiring Flows**

A knockout (diameter 2.42 inches /61.5 mm) is provided above each load wireway within the top panel of the chassis. Use suitable conduits and couplers. Please see the wiring flow diagram on page 8.

**Typical Load Connections**

The examples below show some of the most typical loads and the way in which they are connected to a Source Controller circuit.

**Defining Load Types**

The type of load placed upon each channel must be defined within the Configuration menu of the control panel. For further details on how to do this, please refer to the accompanying System manual.

**Standard Dimmable Load**

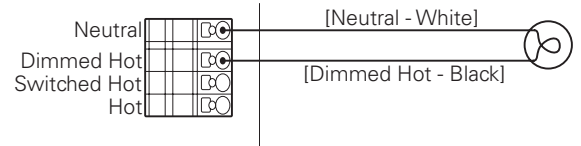

**Non-Dim Load**

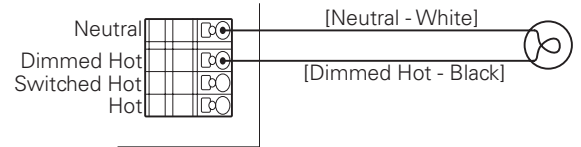

**Constant Load**

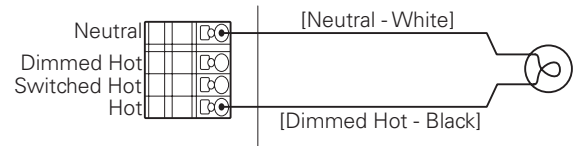

**2 Wire Fluorescent Dimmable Ballast (E.g. Advance Mark X™)**

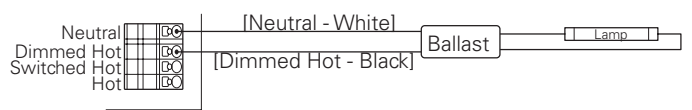

**3 Wire Fluorescent Dimmable Ballast (E.g. Lutron® Hi-Lume® Or Eco-10™)**

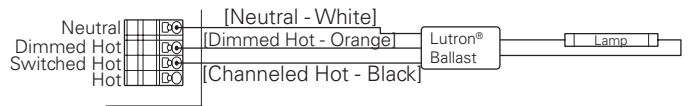

**4 Wire Fluorescent Dimmable Ballast (E.g. 0-10 VDC Control)**

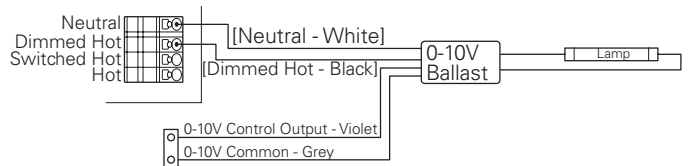

# Load Wiring

## Low Voltage Load Wiring

Each channel can be individually configured to support any of the following low voltage load control standards: 0-10V, DSI or broadcast DALI (DSI and DALI - Canada and Mexico Only). The high voltage sections for each channel continue to provide switched hot outputs to power the controlled loads.

**Note:** Support for multiple low voltage load control standards may not be permissible in certain countries. In such cases, the required control standard must be stated when ordering.

The low voltage load wiring circuits are located just below the control panel, accessible either through a removable mini panel or when the complete casing is removed.

Connections are made easy by using removable plug blocks which snap into terminals mounted on the circuit boards shown below:

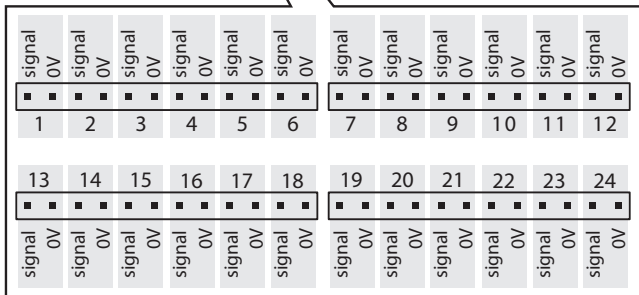
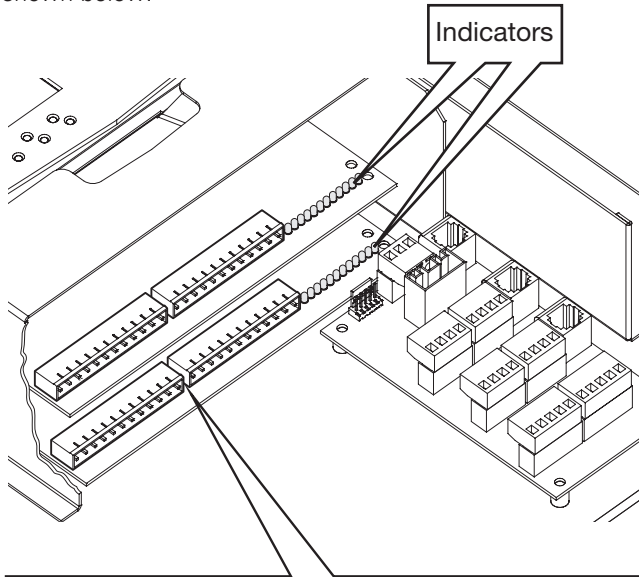

For each circuit, the low voltage control protocol to be used is selected using the configuration menu on the control panel. The programming of the Source Controller channels is covered within the accompanying System Manual.

**Note:** DALI signals for each channel are output in broadcast mode only - it is not possible to individually address multiple DALI luminaires on the same control wire.

The low voltage load control circuits are PELV (Protected Extra Low Voltage).

## Low Voltage Load Wiring Flows

The casing provides four knockouts on the base panel for use by exiting low voltage load cables as well as control wiring. Each knockout is 0.89 inches (22.5 mm) in diameter.

Use appropriate conduits and couplers to link with raceways or cable runs, as necessary.

**IMPORTANT:** Low voltage load wiring should be installed with a suitable separation to parallel high voltage cables, according to local and national codes.

## Indicators

An indicator is assigned to each low voltage output channel to provide quick visual feedback. In each case, the indicator (located next to the output connectors) will mimic the dimmed status of the associated channel, from zero to full brightness.

## Control Wiring

### Multiple Control Protocols

To ensure maximum versatility, the Universal Source Controllers provide full compatibility with a range of control protocols, including:

- iCAN bus
- DMX512A
- RS-485
- Ethernet

Connections for the iCAN bus, DMX512A and RS-485 protocols are made using removable plug blocks which snap into terminals mounted on the control circuit board. A standard RJ45 socket is provided for the ethernet connection.

In addition, a separate connector block (labeled 'Contact closure') allows two volt-free switch inputs from external systems. Subject to configuration menu settings, these inputs can be used to affect selected channels.

The control connections are located just below the control panel, accessible either through a removable mini panel or when the complete casing is removed.

### Termination

The iCAN, DMX and RS-485 are 'daisy-chain' protocols that all require termination on the devices located at either end of the chain.

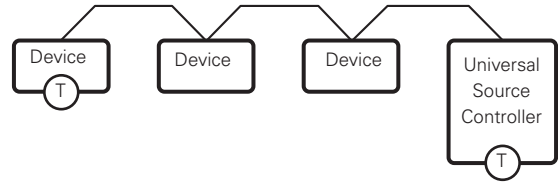

The Switched Relay Controller provide jumper links adjacent to the iCAN, DMX and RS-485 connectors. As standard, all of these interfaces are terminated. To remove termination for a particular bus, move the associated termination jumper from the upper two pins to the lower two pins.

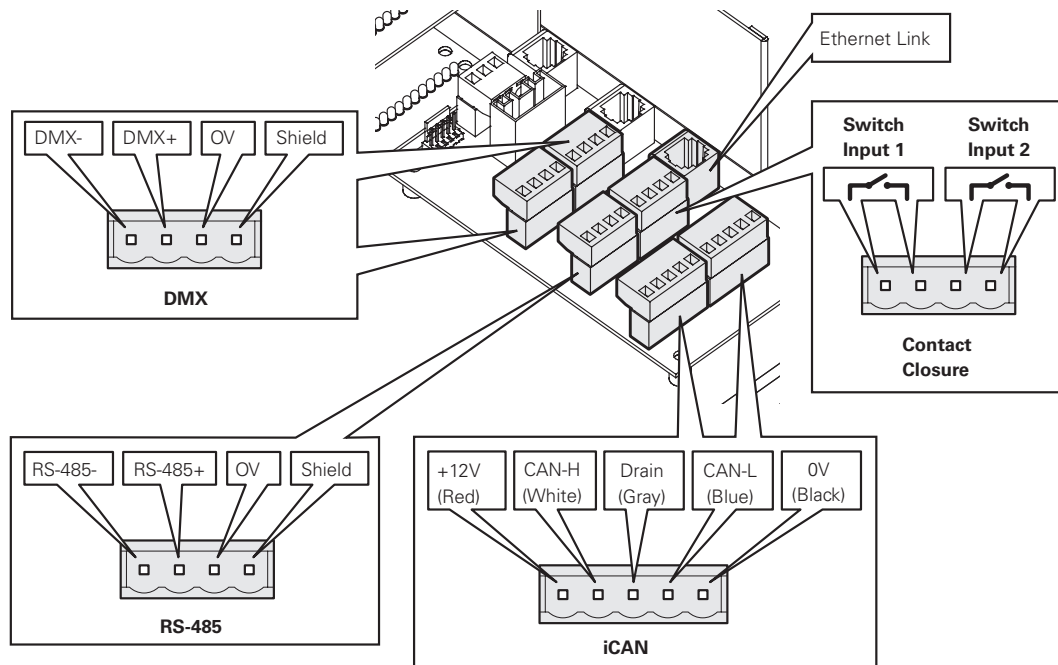
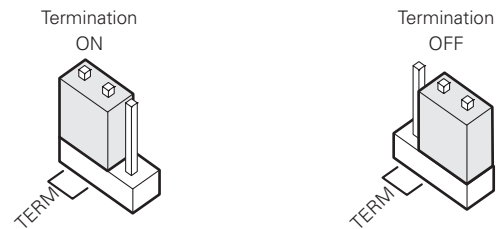

## Control Panel Operation

The main configuration procedures within the control panel are covered within the accompanying System Manual. This section provides a brief overview of the Operation menu.

### Using the Control Panel

Each Universal Source Controller provides a control panel to make configuration and operation as straightforward as possible.

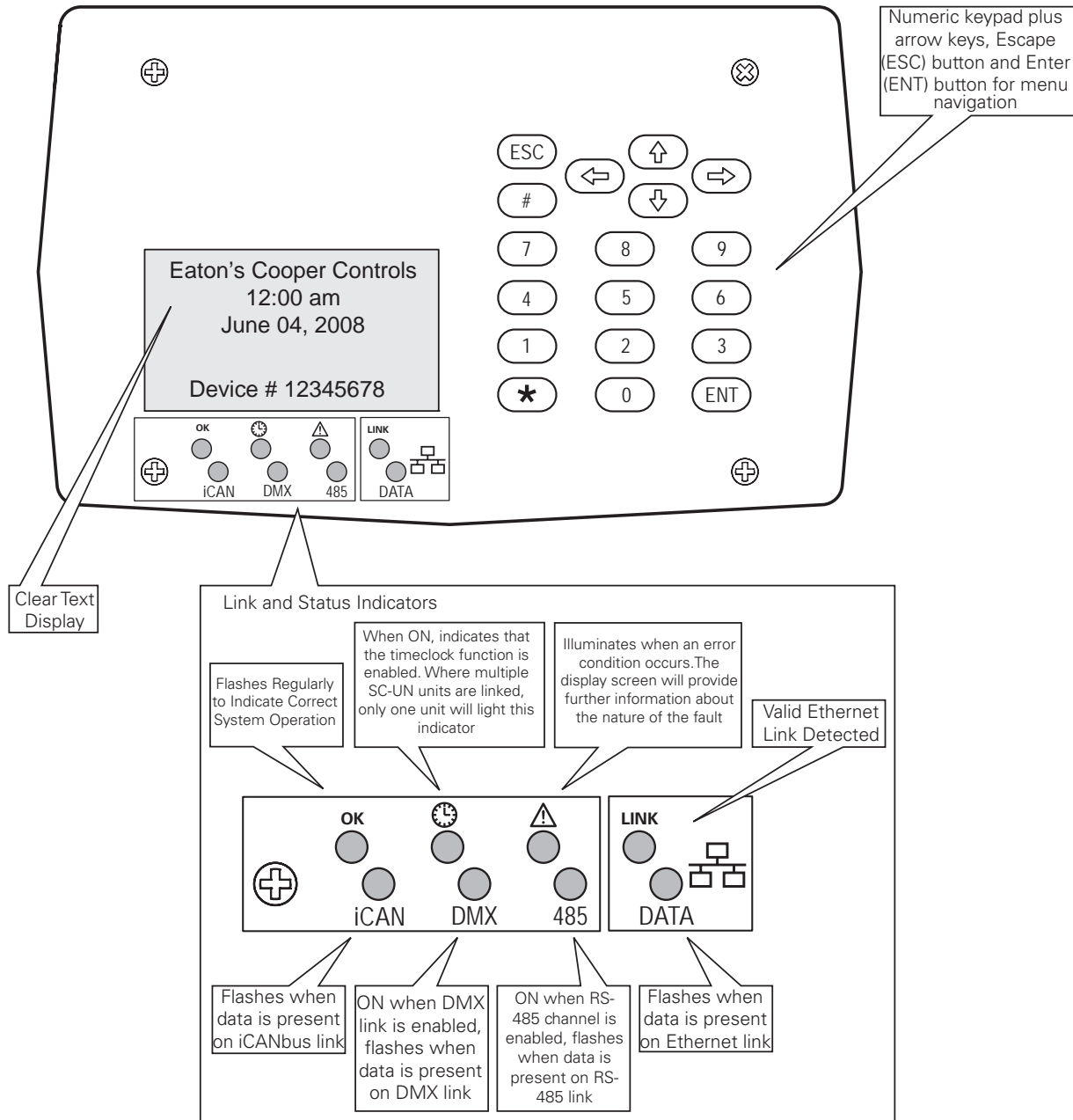

**Accessing the Operation Menu**

During normal service of the Universal Source Controller, the control panel screen shows only the time, date and device number.

**To Access the Operation Menu**

1. Press the **ENT** button to display the Select Access Level menu.
2. With the 'Operation' option highlighted, press the **ENT** button.
3. If requested, enter the four digit operation password and press the **ENT** button.

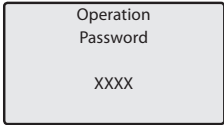
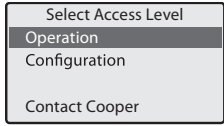

**Note:** When the unit is supplied, there is initially no password - see the section 'Changing the operation menu password' to set one.

4. If the password is accepted, the main 'Operation Menu' will be displayed.

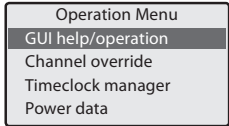

**Menu Navigation**

Within the control panel menu system, use the following buttons to navigate:

**←** **→** **↓** **↑** Use the arrow buttons to move highlight bar to the required option.

**ENT** Press to enter an option or to save your changes to an item.

**ESC** Press to escape from an option to the previous level.

**Operation Menu Contents**

The operation menu provides the following options:

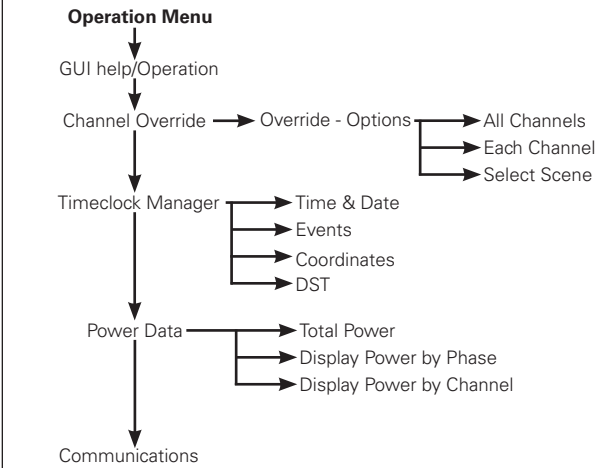

**Overriding Channels**

The override options allow you to alter the output levels on channels directly from the control panel. You can choose to alter all channels collectively, alter selected channels or request a particular pre-programmed scene.

**To Override Channels**

1. From the 'Operation' menu, select the 'Channel override' option and press the **ENT** button. The screen will show the three options:

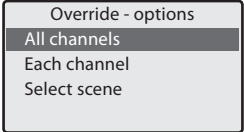

2. Highlight the required option and press the **ENT** button. Depending on the chosen option you will be able to affect outputs as follows:

**All Channels** - Use the **↓** and **↑** buttons to adjust the output level (0 to 100%) for all channels. When the required output level is displayed, press the **ENT** button.

**Each Channel** - Highlight the required channel number using the **↓** and **↑** buttons, then press the **ENT** button. For the chosen channel, use the **↓** and **↑** buttons to adjust the output level (0 to 100%). When the required output level is displayed, press the **ENT** button.

**Select Scene** - Highlight the required scene number using the **↓** and **↑** buttons, then press the **ENT** button.

**Setting the Time and Date**

The Timeclock manager option contains numerous features related to the time and date, including daylight saving time, global coordinates and the selection of changes to channel outputs at set times. For further information about the other Timeclock manager features, please refer to the accompanying System Manual.

**To Adjust the Time and Date**

1. From the 'Operation' menu, select the 'Timeclock manager' option and press the **ENT** button. The screen will show the four options:

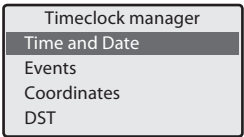

## Control Panel Operation

- Highlight the 'Time and Date' option and press the **(ENT)** button. The current time and date settings will be displayed with the hour entry highlighted:

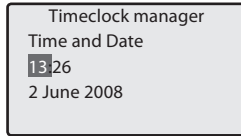

- Use the up and down buttons to move the highlight to the required item. Then use the left and right buttons to alter the highlighted item.
- Press the **(ENT)** button to save and return to the Timeclock manager menu screen.

### Viewing Power Data Readings

The Power data section provides useful feedback and confirmation of the total power demanded by the controller as a whole, the power demand on each phase and also the power drawn on each channel.

#### To Access Power Data

- From the 'Operation' menu, select the 'Power data' option and press the **(ENT)** button. The screen will show the total power currently being drawn as well as two options:

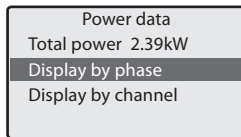

- Highlight the 'Display by phase' option and press the **(ENT)** button to view the phase power distribution:

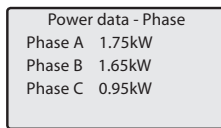

Press the **(ESC)** button to return to the previous level.

- Highlight the 'Display by channel' option and press the **(ENT)** button to view the channel power distribution:

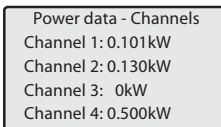

Press the **(↓)** button to view further channels and press the **(ESC)** button to return to the previous level.

### Setting Communications Options

The Communications options section allows you to determine which control protocols should be enabled.

#### To Set Communications Options

- From the 'Operation' menu, select the 'Communications' option and press the ENT button. The screen will show the available control protocols and their current settings:

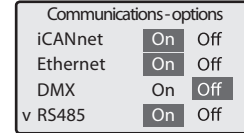

- Highlight the option that you wish to alter and then press the **(★)** button to change its ON/OFF status.
- Press the **(ENT)** button to save your changes and exit.

### Changing the Operation Menu Password

The unit uses two passwords, one for the operation menu and another for the configuration menu. When the unit is supplied, there are initially no passwords. You are strongly recommended to set separate operation and configuration menu passwords at the earliest opportunity. After doing so, ensure that the relevant users are informed of the new passwords.

#### To Set/Change the Operation Menu Password

- From the 'Configuration' menu, select the 'Password Manager' option and press the **(ENT)** button. If a previous password has been set, the screen will prompt you to enter the current password:

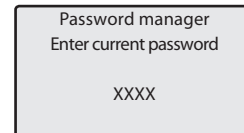

Use the keypad to enter the current password. As you type, each digit will be represented by an 'X'.

If you enter a character incorrectly, press the **(ESC)** button to erase it.

When you have entered the code, press the **(ENT)** button.

- Highlight the required password to set/change: Operation or Config, then press the ENT button.

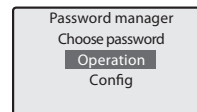

- Enter your new code (4 digits) and press the **(ENT)** button. Then re-enter the code again and press the **(ENT)** button. If the two new codes match, you will be given the option to save.
- Highlight the 'Yes' option and press the **(ENT)** button.

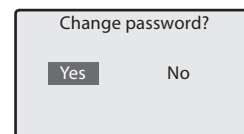



## WARRANTIES AND LIMITATION OF LIABILITY

Please refer to [www.coopercontrol.com](http://www.coopercontrol.com) under the Legal section for our terms and conditions.

**Eaton**  
1000 Eaton Boulevard  
Cleveland, OH 44122  
United States  
[Eaton.com](http://Eaton.com)

Eaton's Cooper Controls Business  
203 Cooper Circle  
Peachtree City, GA 30269  
[CooperControl.com](http://CooperControl.com)

© 2014 Eaton  
All Rights Reserved  
Printed in USA  
P/N: 9850-00020-01

Eaton is a registered trademark.

All trademarks are property  
of their respective owners.