

DESCRIPTION

Art glass pendants offer the opportunity to add a truly unique touch to lighting needs in both commercial and residential spaces. They can add a pleasant free flowing accent in reception or hospitality areas or they can be used for general lighting with their inviting pools of muted illumination. Large haloid 12V pendants use MR16 or T4 lamps. Four styles are available in small and large sizes.

| | | |
|-------------|--|------|
| Catalog # | | Type |
| Project | | |
| Comments | | Date |
| Prepared by | | |

SPECIFICATION FEATURES

A ... Electrical Quick Lock Adapter - Linea

Polycarbonate housing. Attaches electrically and mechanically anywhere along Linea Track.

B ... Canopy - Surface Mount

Aluminum canopy with integral 12V transformer. Attaches to standard junction box.

C ... Shade

Hand crafted art glass. Art Glass Shades may vary in color, pattern and shape due to their handmade nature. Slight imperfections add to their charm. Art Glass Shades are made in the United States of America.

D ... Finial

Machined brass finial.

E ... Cord

Field adjustable 8' long 18AWG clear-jacketed cord.

Labels

ETL Classified.

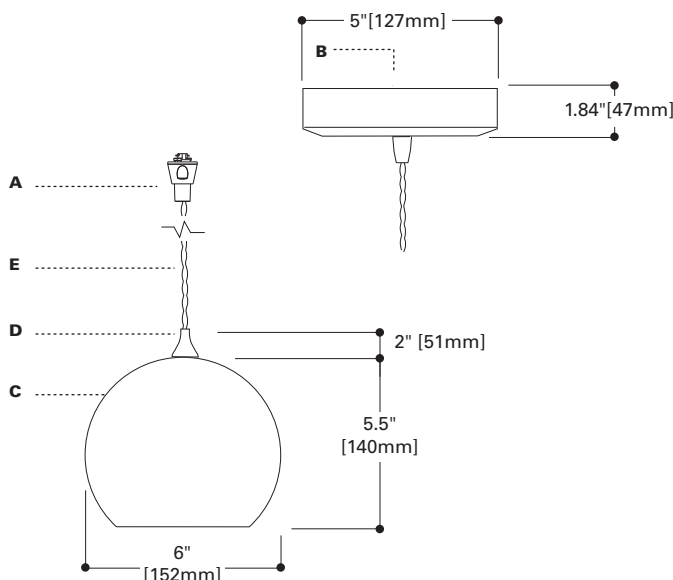

LV2HALOSML H2HALOSML

**Art Glass Low Voltage
Pendant
Small Haloid
50W MR16/T4**

Linea
Surface

ORDERING INFORMATION

| | | | | | | |
|--|-----------------------------|--|---|---|--------------------------------|---|
| HALO | | 4 | | SML | | |
| Track LV2= Linea Track H2=Low Voltage Surface Mount (includes electronic transformer) | Style HALO=Haloid | Finial Finish AH=Aluminum Haze BRZ=Bronze (H2 only) | Lamp Type (not included) 4=12V MR16, T4 | Adapter/Canopy Finish Blank=Same as Finial BRZ=Bronze (H2 only) P=White MB=Black | Shade Size SML=Small | Shade Colors AmberIce=Amber Ice AmberWeb=Amber Web Blueberry=Blueberry Swirl Butterscotch=Butterscotch Twist Candy=Candy Apple Caramel=Caramel Cherries=Cherries Jubilee Coconut-Tahitian Coconut Indigo=Indigo Irish=Irish Coffee Licorice=Black Licorice Marshmallow=Marshmallow Swirl MossyIce=Mossy Ice MossyWeb=Mossy Web Plum=Plum Wine Rocky=Rocky Road Sandstone=Sandstone Sea Moss=Sea Moss Smoke=Smoke Spumoni=Spumoni |

SHADE COLORS

Halo Art Glass shades may vary in color, pattern and shape due to their handmade nature. Slight imperfections add to their charm and unique character.

Shown below are swatches of available shade finishes. Please note that the representations of these color swatches are subject to certain limitations due to variations of printing and viewing equipment.

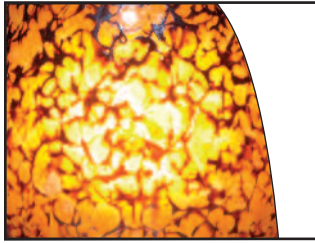

Amber Ice

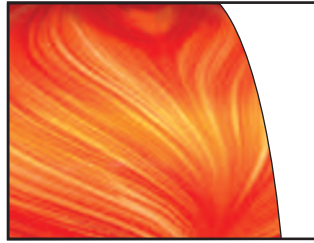

Candy Apple



Marshmallow Swirl

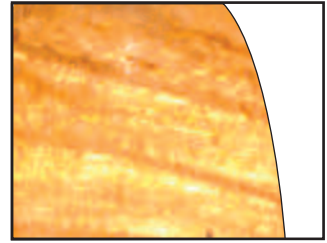

Sandstone

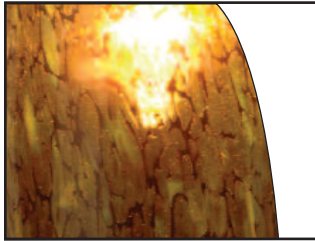

Amber Web



Caramel

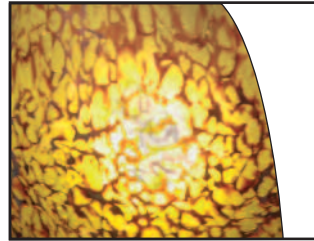

Mossy Ice

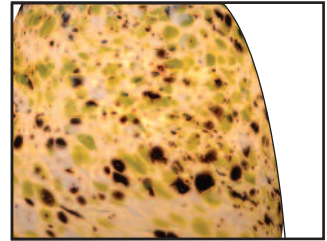

Sea Moss

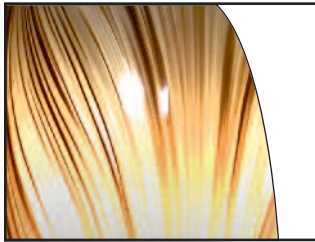

Black Licorice

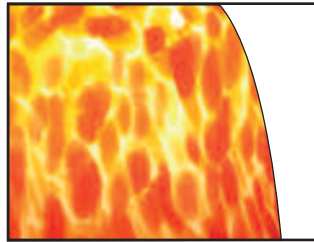

Cherries Jubilee

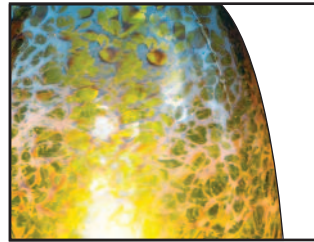

Mossy Web



Smoke

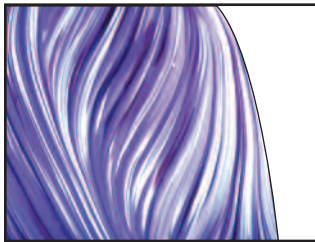

Blueberry Swirl

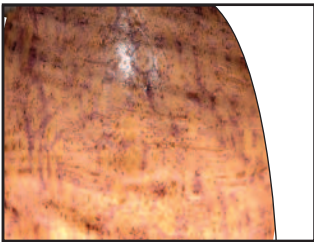

Indigo

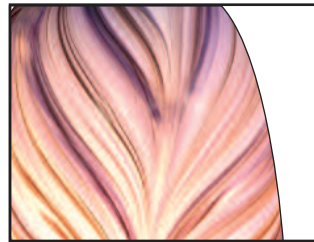

Plum Wine

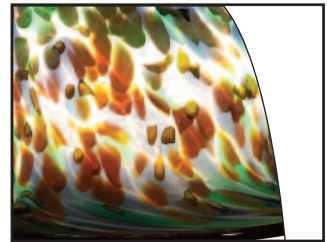

Spumoni



Butterscotch Twist

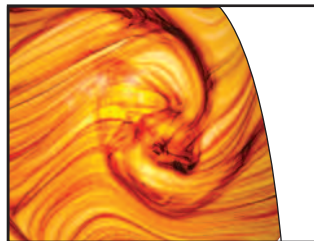

Irish Coffee



Rocky Road



Tahitian Coconut