

**LZRC201, LZRC203**  
**Current Limiter - End and Center Feeds**

End-feed and Center-feed capable:  
Five breaker sizes are available. Consult factory if other sizes are required. Can be utilized on hard or grid ceilings. Can be used with pendant suspended track. Breaker can be used as an on-off switch. Breaker features a "tripped" condition indicator. Approved by the California Energy Commission – meets Title 24 requirements. cULus Listed

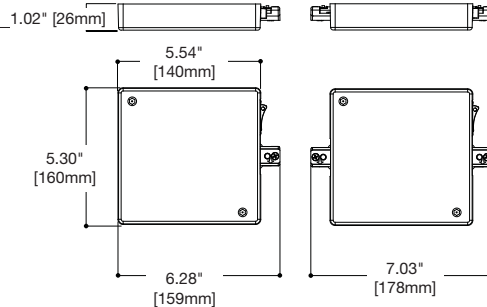

**LZRC201**  
**LZRC203**

Feed Type	Circuit Breaker	Finish
<b>LZRC201</b> = Lazer 1-Circuit End Feed	<b>CB120</b> = 120W (1A @ 120V) <b>CB300</b> = 300W (2.5A @ 120V) <b>CB600</b> = 600W (5A @ 120V) <b>CB960</b> = 960W (8A @ 120V) <b>CB1200</b> = 1200W (10A @ 120V)	<b>P</b> = White <b>MB</b> = Black
<b>LZRC203</b> = Lazer 1-Circuit Center Feed		

Sample catalog number: LZRC201CB120P  
(Field assembly of feed and circuit breaker required)

Consult factory for Single Circuit Center-feed requiring two circuit breakers

Connectors specifically for Lazer-by-Halo Track sections. Use for forming almost any configuration of track layouts.

**LZR208 Cord and Plug Feed**

10' three-wire cord with grounded plug. Maximum capacity 5 AMPS.

Finish Codes: P, MB

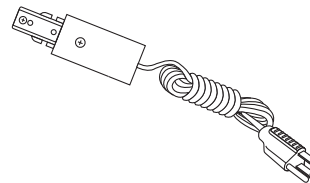

**LZR208**

**ORDERING INFORMATION**

Connector	Finish
<b>LZR208</b>	

**LZR211 Flexible Connector Feed**

To connect two track sections at any angle up to 90° or for connecting wall and ceiling mounted track. Can be used as electrical feed point.

Finish Codes: P, MB

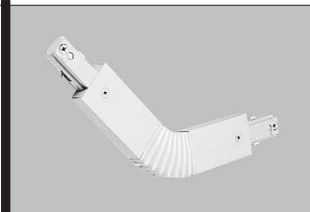
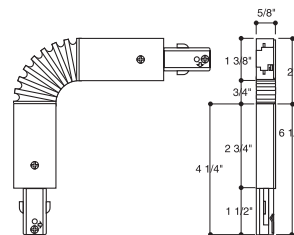

**LZR211**

**ORDERING INFORMATION**

Connector	Finish
<b>LZR211</b>	

**LZR212 Mini Connector**

For joining two track sections end-to-end. LZR212 is not an electrical feed.

Finish Codes: P, MB

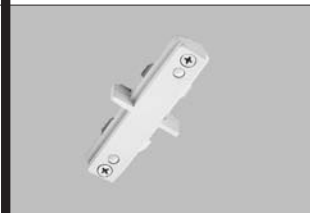
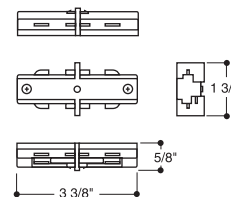

**LZR212**

**ORDERING INFORMATION**

Connector	Finish
<b>LZR212</b>	

**LZR200 Live End Feed with Junction Box Cover**

For starting a track run at beginning of track and when connector is mounted to a junction box.

Finish Codes: P, MB

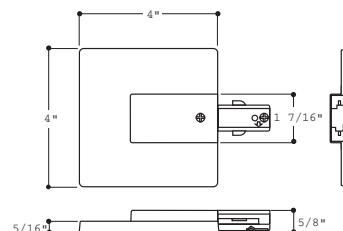

**LZR200**

**ORDERING INFORMATION**

Connector	Finish
<b>LZR200</b>	

**LZR201 Live End Feed**

For starting a track run at beginning of track.

Finish Codes: P, MB

**ORDERING INFORMATION**

Connector	Finish
<b>LZR201</b>	

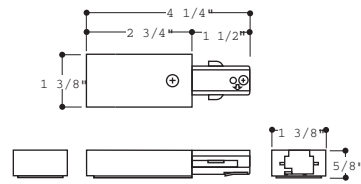

**LZR201**

**LZR202 Floating Canopy and Connector Feed**

Track can be connected to existing outlet box located anywhere along the track. Comes with canopy cover, connector, dead end and mounting hardware.

Finish Codes: P, MB

**ORDERING INFORMATION**

Connector	Finish
<b>LZR202</b>	

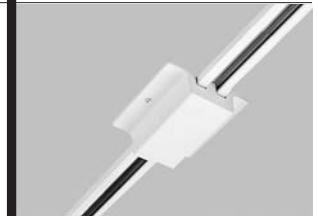
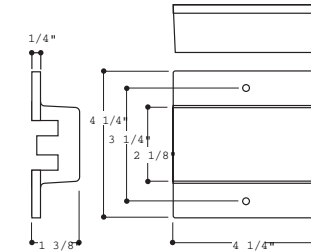

**LZR202**

**LZR203 Adjustable "L" and Straight Connector Feed**

To connect two track sections at right angles or straight end-to-end. Includes straight and right angle covers. Can be used as an electrical feed.

Finish Codes: P, MB

**ORDERING INFORMATION**

Connector	Finish
<b>LZR203</b>	

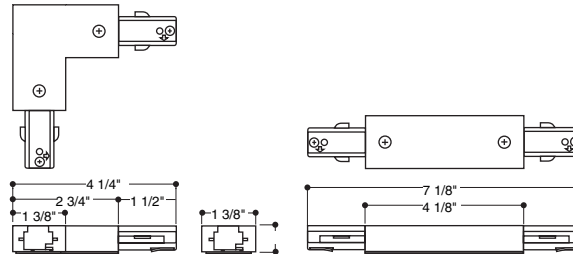

**LZR203**

**LZR213R "T" Connector (Right)**

**LZR213L "T" Connector (Left)**

Use for joining three track sections. Select Right(R) or Left (L) Handed versions to maintain proper polarity. May be used as an electrical feed point.

Finish Codes: P, MB

**ORDERING INFORMATION**

Connector	Finish
<b>LZR213R</b>	
<b>LZR213L</b>	

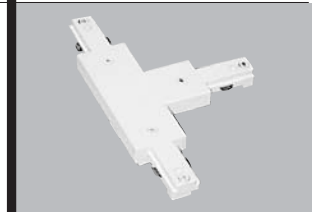
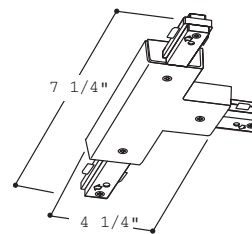

**LZR213**

**LZR214 "X" Connector**

Use for joining four track sections. May be used as an electrical feed point.

Finish Codes: P, MB

**ORDERING INFORMATION**

Connector	Finish
<b>LZR214</b>	

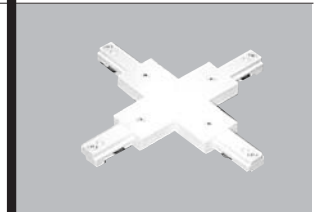
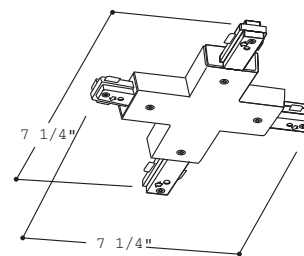

**LZR214**

**LZR204 Conduit Adapter Feed**

Designed to accept 1/2" trade size conduit fitting (not supplied). Use when feeding to track through surface conduit system.

Finish Codes: P, MB

**ORDERING INFORMATION**

Connector	Finish
<b>LZR204</b>	

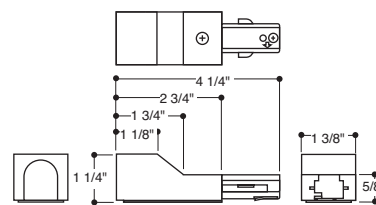

**LZR204**

**LZR205 Conduit Continuation Feed**

Includes one left feed and one right feed to continue a run around obstructions. Requires 1/2" trade size fitting (not included).

Finish Codes: P, MB

**ORDERING INFORMATION**

Connector	Finish
<b>LZR205</b>	

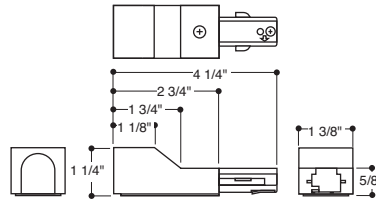

**LZR205**

**LZR206 T-Bar Canopy Feed**

For installing track on T-Bar ceilings. LZR201 or LZR203 also required.

Finish Codes: P

**ORDERING INFORMATION**

Connector	Finish
<b>LZR206</b>	

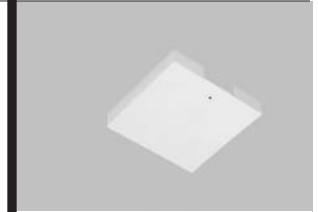
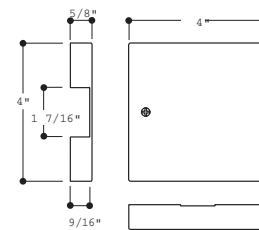

**LZR206**

**LZR207 T-Bar Mounting Clip**

For installing track to a suspended ceiling. Kit contains 3 clips for mounting 2', 4', 6', or 8' track. Order one kit for each track section. Compatible with Halo and Lazer track.

**ORDERING INFORMATION**

Connector	Finish
<b>LZR207</b>	

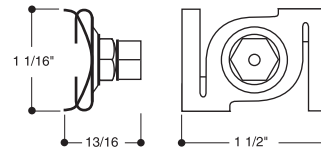

**LZR207**

Lazer monopoints allow the installation of a single lampholder without using a complet track instalaltion

**LZR209 Monopoint Feed**

For installing one Halo or Lazer track lampholder. Mounts directly to junction box. 500 watt maximum. Not compatible with Halo or Lazer low voltage lampholders with integral solid state power supplies.

Finish Codes: P, MB

**ORDERING INFORMATION**

Connector	Finish
<b>LZR209</b>	

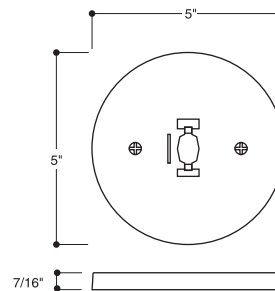

**LZR209**

**LZR210 Monopoint Feed - Low Voltage**

For installing one Halo or Lazer low voltage lampholder. Mounts directly to junction box. 500 watt maximum.

Finish Codes: P, MB

**ORDERING INFORMATION**

Connector	Finish
<b>LZR210</b>	

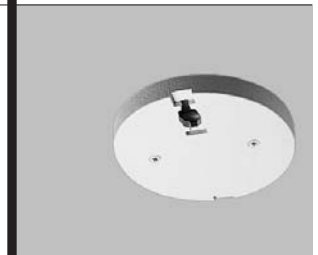
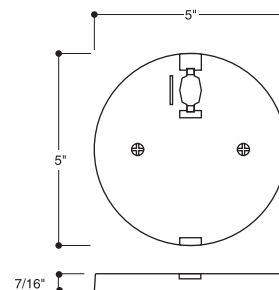

**LZR210**