

DESCRIPTION

The Corelite Hugo LED combines architectural quality construction and performance in a cost effective linear solution. Designed for individual or continuous row applications, the Hugo utilizes advanced LED technology in a clean, slim profile and delivers up to 145 lumens per watt. Available in up to 2,000 lumens per foot with a wide array of optional features, the Hugo is easy to use in a variety of building environments including retail, supermarket, commercial office, and educational facilities.

Catalog #		Type
Project		
Comments		Date
Prepared by		

SPECIFICATION FEATURES

Construction

Compact extruded aluminum housing forming a 3.5" x 3.4" profile. Replaceable gear tray is die-formed 20 gauge galvanized steel and provides access to drivers from above. Removable top access plates located on both ends for ease of wiring/joining.

End Caps

End caps are die-cast aluminum with decorative cover plate to conceal fasteners. End cap adds 1" to each end.

Light Engine

LED's are available in 3000K, 3500K or 4000K with CRI options of either ≥80CRI or ≥90CRI. Lumen output will be affected - please refer to the lumen adjustment factor table.

Electrical

Long-Life LED system coupled with integral electronic drivers to deliver optimal performance. Standard with 120-277V 0-10V dimming drivers (1% standard). 347V 0-10V drivers are available. Dimming wires come standard but can be capped in the field for standard switched operation. A single power feed drop supplied as standard.

Controls

Options compatible with Cooper Lighting Solutions' Connected Lighting Systems:

- WaveLinX sensor
- LumaWatt Pro sensor
- Fifth Light DALI driver

Refer to the Connected Lighting options page and ordering information for more details.

Mounting

Surface mount fixture mounts directly to structure over a 2" x 4" standard electrical box (by others) mounted parallel to fixture into the ceiling. All sections are continuously wired with snap quick connects for fast installation. Refer to installation instructions for various ceiling interface details. Suspended mount available - see suspended specification sheet.

Finish

Electrostatically applied polyester powder coat paint in white, silver, or black. RAL custom colors are available.



HUGO - HGL

LED

Surface Mounted
Direct / Semi-Direct

cULus - 1598
Damp Location Listed
LM79/LM80 Compliant
ROHS Compliant
DesignLights Consortium® Qualified
Assembled in USA

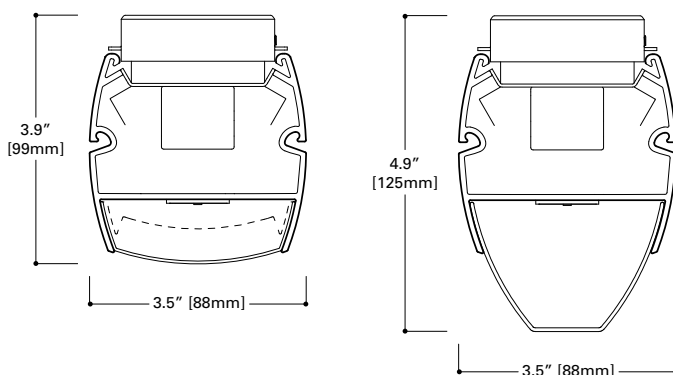

ORDERING INFORMATION

Sample Number: HGL-S-BF-40L835-1D-UNV-STD-SWPD1-ILB12-W-SU-24

Series	Size	Shielding/Optics	Lumen Package Nominal per 4' section	CRI / Color Temperature	Circuiting	Specialty Wiring	Input Voltage
HGL = HUGO Linear LED	S = Small	FR = Frosted Lens BF = Baffle with Frosted Diffuser BA = Baffle with Aisle/Stack Optic UF = Frosted Drop Lens (12% Uplight)	30L = 3,000 Lms (750 lms/ft) 40L = 4,000 Lms (1,000 lms/ft) 50L = 5,000 Lms (1,250 lms/ft) 60L = 6,000 Lms (1,500 lms/ft) 80L = 8,000 Lms (2,000 lms/ft)	830 = LED 3000K, 80 CRI 835 = LED 3500K, 80 CRI 840 = LED 4000K, 80 CRI 930 = LED 3000K, 90 CRI 935 = LED 3500K, 90 CRI 940 = LED 4000K, 90 CRI	1 = 1 Circuit	D = None E = Emergency Circuit S = Secondary Circuit N = Emergency + Secondary Circuit	UNV = Universal (120V-277V) 347 = 347V
			Refer to performance table on Page 3 for more detail. 80L lumen package not available with 347V "STD" driver.	Additional lead-time may apply for 930, 935 and 940 configurations.	Refers to wiring in cross section.	Select "D" wiring for individual fixtures. Emergency and Secondary circuit section wiring are configured per unit (4ft, 8ft, or 12ft). Secondary circuit not available with integrated sensor options.	Integral 347V driver with STD 0-10V option only. Factory supplied 347V remote transformer for all other driver options.

Driver/Dimming Options	Integrated Sensor	Integral Emergency	Finish	Mounting	Run Length
STD = Standard 0-10V (1%-100%) 5LT = Fifth Light DALI (5%-100%) LH = Lutron HiLume 1% EcoSystems L5 = Lutron 5-Series 5% EcoSystems	SWPD1 = WaveLinX Wireless Integrated Sensor LWIPD1 = LumaWatt Pro Wireless Integrated Sensor	ILB12 = 12-watt battery pack, 120V-277V, Iota ILB-SL-CP12 EPC = UL924 Bypass Relay	W = White S = Silver B = Black CC = Custom Color	SU = Ceiling Surface Mount	4 = 4 ft. 8 = 8 ft. XX = Specify Row Length
	Must be used with "STD" driver. Integrated sensor not available with UF shielding option. Integrated Sensors combined with Emergency Circuit require one UL924 Bypass Relay per emergency fixture.	30°C max ambient temperature rating when integral battery selected.		Surface mount bracket is pre-installed on luminaire. Consult factory for grid ceiling mounting.	12' unit not available for surface mounting. Standard row configurations over 8' consist of 4' and 8' luminaires.

Lengths

Available in 4-ft and 8-ft sections. All sections are modular eliminating the need for starter, joiner and end sections. Standard row configurations over 8-ft consist of 4-ft and 8-ft luminaires unless otherwise specified.

Shielding

FR: High transmission 0.05" thick frosted acrylic snap-in lens.

BF: Continuous injection molded cross baffles with 1" opening for brightness management and frosted acrylic diffuser to shielding direct view of LEDs.

BA: Continuous injection molded cross baffles with 1" opening for brightness management and precision aisle/stack linear optic to deliver optimal vertical illumination in aisle applications.

UF: High transmission 0.05" thick frosted acrylic snap-in lens that drops below fixture housing for luminous sides and 12% upright.

Lumen Maintenance

Projected lumen maintenance based on TM-21 standards is L84 > 60,000 hours at 25°C ambient conditions.

Emergency Options

Optional 120V-277V integral emergency battery pack is 12W maximum, 90 minute output, and powers a 4-foot section. Test switch/indicator button located in side mount attachment. For approximate delivered lumens multiply the lumens per watt of the desired fixture by the wattage of the emergency battery pack (100 lm/W x 12 = 1200 lumens). The combination of integrated sensor and emergency circuit options require an EPC UL924 bypass relay that disables sensor control of emergency fixtures when normal power is lost.

Integrated Sensing and Control Systems

Integrated options must be used in conjunction with the associated system and may not be compatible with other options or accessories. Please consult WaveLinx and LumaWatt Pro system pages for additional details and compatibility. Consult

Marketplace Options - Lutron system pages for additional details and compatibility. Requires field commissioning to operate or dim. Contact Lutron at www.lutron.com.

Weight

4.0 lbs per foot.

Compliance

Modules are UL recognized components and indoor luminaires are cULus listed for 40°C ambient environments, damp location listed, and RoHS compliant. LED modules comply with IESNA LM-79 and LM-80 standards. FR version is DesignLights Consortium® Qualified and classified for both DLC Standard and DLC Premium, refer to www.designlights.org for details.

Warranty

Five year warranty.

SHIELDING OPTIONS



Frosted Lens (FR)



Baffle / Frosted Diffuser (BF)



Baffle / Aisle Optic (BA)



Frosted Drop Lens (UF)

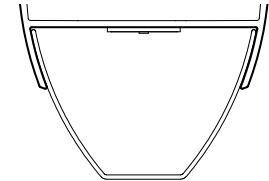
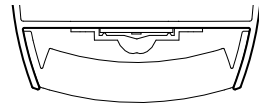
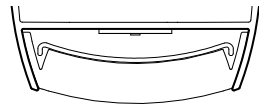
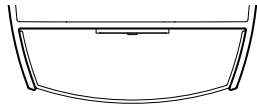

Fixture Lengths

48" [1219 mm]

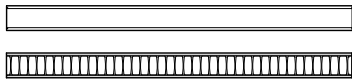

96" [2483 mm]

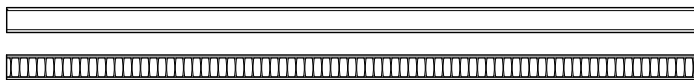

SENSOR INTEGRATION

Integrated sensors are located in the middle of each section (4', 8', or 12') for individual and continuous runs. Minor field adjustments of the sensor location are possible along the length of the fixture. Each section can be individually controllable with the integrated sensors.

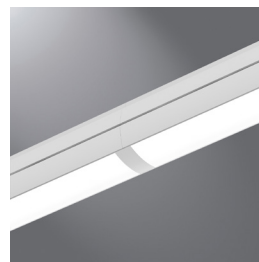

JOINTS (FR/UF VERSIONS ONLY)

Powdercoat paint white spring steel joint snaps into housing between fixture sections to eliminate lens gaps and light leaks.

Hugo HGL LED Performance (3500K/80CRI)				4 ft.			8 ft.*		
Series/ Distribution	Lumen Package	Delivered Lumens		Wattage		Efficacy LPW	Wattage		Efficacy LPW
		4FT	Per FT	4FT	Per FT		8FT	Per FT	
HGL-FR	30L	3150	788	23	5.8	136	45	5.6	141
	40L	3978	995	30	7.4	134	58	7.3	137
	50L	4979	1245	39	9.6	129	75	9.3	133
	60L	6016	1504	49	12.2	124	95	11.8	127
	80L	8131	2033	71	17.7	115	141	17.6	115
HGL-BF	30L	2679	670	23	5.8	115	45	5.6	120
	40L	3383	846	30	7.4	114	58	7.3	117
	50L	4234	1058	39	9.6	110	75	9.3	114
	60L	5116	1279	49	12.2	105	95	11.8	108
	80L	6914	1729	71	17.7	98	141	17.6	98
HGL-BA	30L	3025	756	23	5.8	130	45	5.6	136
	40L	3820	955	30	7.4	129	58	7.3	132
	50L	4781	1195	39	9.6	124	75	9.3	128
	60L	5777	1444	49	12.2	119	95	11.8	122
	80L	7808	1952	71	17.7	110	141	17.6	111
HGL-UF	30L	3185	796	23	5.8	137	45	5.6	143
	40L	4022	1006	30	7.4	136	58	7.3	139
	50L	5034	1258	39	9.6	131	75	9.3	135
	60L	6082	1521	49	12.2	125	95	11.8	129
	80L	8221	2055	71	17.7	116	141	17.6	117

*Delivered lumens for 8ft units are multiples of 4ft values. Input wattages per foot vary per unit length.

LUMEN ADJUSTMENT FACTORS

CCT	80 CRI	90 CRI
3000K	0.964	0.830
3500K	1.000	0.861
4000K	1.015	0.883

Example Calculation:

FR / 40L / 3500K / 80 CRI

Lumen Output selected = 995 lms/ft

3500K / 90 CRI Desired

Lumen Adjustment Factor = 0.861

Adjusted Lumen Output = 995 lms/ft x 0.861 = 857 lms/ft

LUMEN MAINTENANCE

Ambient Temperature	TM-21 Lumen Maintenance (60,000 hours)	Theoretical L70 (Hours)
25°C	>85%	129,000
40°C	70%	60,000

PHOTOMETRICS

HUGO SURFACE MOUNT - HGL

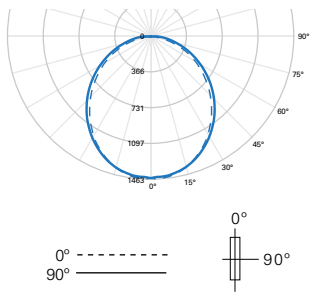

FILE NAME: HGL-S-FR-40L835-UNV-4.IES

ZONAL LUMENS SUMMARY

LUMINANCE DATA (cd/M²)

CCT: (LD5) LED 3500K
LUMENS: 3978 Lm
WATTS: 29.6 W
EFFICACY: 134 Lm/W
TEST NO.: P231393

Zone	Lumens	% Fixture
0°-30°	1108	27.8
0°-40°	1791	45.0
0°-60°	3093	77.7
0°-90°	3952	99.3

Vertical Angle	0°	45°	90°
45°	14360	14449	14657
55°	13308	13402	13714
65°	12171	12222	12664
75°	10095	10615	11569
85°	6779	10275	13040

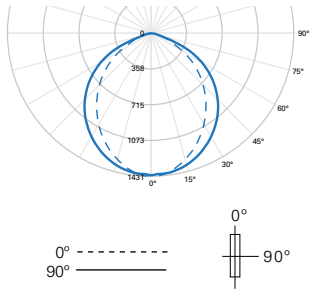

FILE NAME: HGL-S-BF-40L835-UNV-4.IES

ZONAL LUMENS SUMMARY

LUMINANCE DATA (cd/M²)

CCT: (LD5) LED 3500K
LUMENS: 3383 Lm
WATTS: 29.6 W
EFFICACY: 114 Lm/W
TEST NO.: P256939

Zone	Lumens	% Fixture
0°-30°	1058	31.3
0°-40°	1695	50.1
0°-60°	2859	84.5
0°-90°	3383	100

Vertical Angle	0°	45°	90°
45°	12144	12990	14956
55°	1027	11548	13799
65°	6657	9519	10976
75°	5295	5875	3321
85°	3939	3981	2120

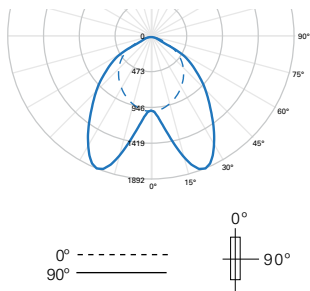

FILE NAME: HGL-S-BA-40L835-UNV-4.IES

ZONAL LUMENS SUMMARY

LUMINANCE DATA (cd/M²)

CCT: (LD5) LED 3500K
LUMENS: 3820 Lm
WATTS: 29.7 W
EFFICACY: 129 Lm/W
TEST NO.: G3-1803-682-1

Zone	Lumens	% Fixture
0°-30°	1141	29.9
0°-40°	1944	50.9
0°-60°	3301	86.4
0°-90°	3820	100

Vertical Angle	0°	45°	90°
45°	7939	14131	13531
55°	7473	11024	10944
65°	6042	8572	4340
75°	4772	5876	2885
85°	3596	5076	2221

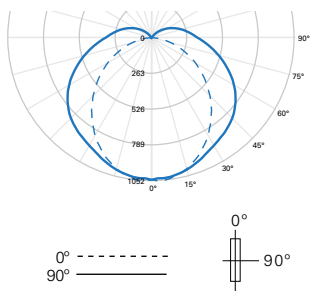

FILE NAME: HGL-S-UF-40L835-UNV-4.IES

ZONAL LUMENS SUMMARY

LUMINANCE DATA (cd/M²)

CCT: (LD5) LED 3500K
LUMENS: 4022 Lm
WATTS: 29.6 W
EFFICACY: 136 Lm/W
TEST NO.: P257051
 12% UP / 88% DOWN

Zone	Lumens	% Fixture
0°-30°	800	19.9
0°-90°	3546	88.2
90°-130°	461	11.5
90°-180°	477	11.8
0°-180°	4022	100

Vertical Angle	0°	45°	90°
45°	9820	8830	9539
55	8834	8448	9323
65°	7722	8093	8974
75°	6325	7759	8619
85°	4263	7716	8491

COLOR DATA (3500K)

		80CRI
TM-30-15	R _f	82.6
	R _g	94.9
CRI/CIE	R _a	83.8
	R _g	15.5