

NOTE: THIS VERSION OF THE DEFINE SERIES HAS BEEN REPLACED WITH OUR SECOND GENERATION PRODUCT

DESCRIPTION

The Define series by Neo-Ray characterizes the ultimate in minimalist simplicity by providing clean, uniform lines of illumination in virtually any architectural environment. Powered by Cooper Lighting Solutions' most advanced linear LED technology, the Define series delivers outstanding efficacy in a variety of profile widths. 2", 3", 4" and 5" luminaire widths are all specifiable to the nearest foot as standard product and can be fitted with flush, regress and drop lensing. Custom corners and transitions are also available. Robust construction and adaptable, modular components make installation simple and ensure laser straight runs.

Catalog #		Type
Project		
Comments		Date
Prepared by		

SPECIFICATION FEATURES

Construction

Housing extruded from 6063 aluminum. Nominal 2' -12' illuminated sections. Used in run configuration and/or individual fixtures. All components are RoHS compliant.

Lens

Snap in lens available in flush and drop lens profiles. Snap in end clips eliminate light leak and prevent moisture and insect ingress.

Finish

Fixture housings are high reflectance white using electrostatically applied polyester powder coat paint.

Electrical

Long-life LED system coupled with electrical driver to deliver optimal performance. LED's are available in 2700K, 3000K, 3500K or 4000K with a typical CRI ≤ 85. Projected life is 153,000 hours at >79% lumen output. Electronic drivers are available for 120-277V applications. Fixtures and electrical components certified to UL and CUL standards. Fixtures are damp location listed.

Controls

Equipped standard with a 0-10V continuous dimming driver compatible with most standard dimming devices (refer to website for specific compatibility reference).

Combine with FifthLight DALI and other energy saving products like sensors, daylighting controls and building management systems to maximize energy savings.

Mounting

Wall.

Pendant with single aircraft cable and circular canopy. Standard length of canopy is 48".

Warranty

Five year warranty.



Define 2

Wall

LED

Direct/Indirect

CERTIFICATION DATA
cULus - 1598
Damp Location Listed
LM79/LM80 Compliant
RoHS Compliant
Lumawatt Pro Wireless

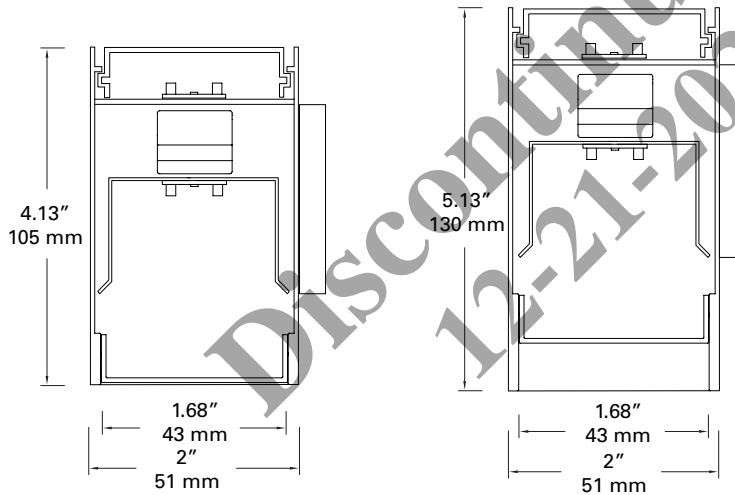

ORDERING INFORMATION

Sample Number: S122DIW-ULO-235-0048-1D-UDD-1-NA-W

SERIES	LIGHT DISTRIBUTION	LIGHT LEVEL UP ¹	LIGHT LEVEL DOWN ¹	COLOR TEMP	LENGTH ³	CIRCUITING >>
S122 = Define 2	DIW = Direct / Indirect Wall RDIW = Regressed Direct / Indirect Wall	-ULO = Light Level ULO 437 Lm/Ft* -U1 = Light Level U1 851 Lm/Ft* -U2 = Light Level U2 1225 Lm/Ft* <small>See page 2 for lumen output *Tested with no lens up</small>	-LO = Light Level LO 299 Lm/Ft* -1 = Light Level 1 582 Lm/Ft* -2 = Light Level 2 838 Lm/Ft* <small>See page 2 for lumen output *Tested with satin lens down</small>	27 = 2700K 30 = 3000K 35 = 3500K 40 = 4000K	-0048 = 4' Individual -0096 = 8' Individual -0144 = 12' Individual -XXXX = Configurable Run ⁵	-1 = Single Circuit -2 = Dual Circuit
CIRCUIT TYPE	VOLTAGE	LED DRIVER	SHIELDING DOWN	SHIELDING UP	COLOR	OPTIONS ⁹
>> D = Dimming (std) C = Non-Dimming B = Battery Pack ⁸ E = Emergency G = Bodine GTD	-1 = 120V -2 = 277V -U = Universal 120V-277V -3 = 347V ⁶	ED = Non-Dimming DD = 0-10V Dimming (std) HCD = 1% 0-10V Dimming 5L = DALI Dimming ⁷	-1 = Satin White Diffuser -3 = Asymmetric Flush -4 = Satin Drop Diffuser	-NA = No Lens (std) -5 = Satin White Diffuser	-W = Matte White -S = Silver -B = Black -C = Custom Color	SVPD1 = Integrated Sensor ¹³ LWIPD1 = Lumawatt Pro Wireless Integral Sensor ¹³ -90 = 90-CRI (Lower Lumens) -R = GLR Fast Fusing -F = GMR Slow Fusing

Notes:
* See page 4 for specific notes

Photometric Data - All data certified to LM-79 standards in a NAVLAB approved testing facility

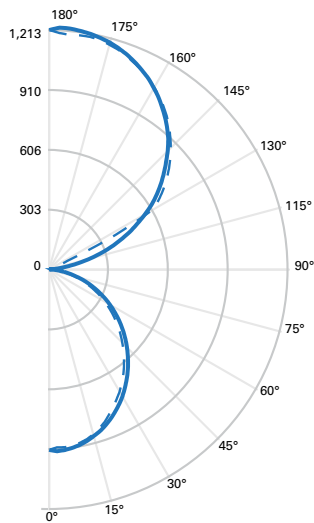

Filename: S122DIP-U1-135-SC48-SR0048-1D-UDD-1-NA-W
 Test Number: P189501
 Lumens: 5731.6 Lms
 Watts: 52 W
 LPW: 110.2 Lm/W
 CCT: 3500K

ZONAL LUMEN STUDY		
Zone	Lumens	% Fixture
0-30	684	11.9
0-40	1100	19.2
0-60	1880	32.8
0-90	2330	40.6
90-180	3402	59.4

LUMINANCE DATA (cd / sq.m)			
Angle	0-Deg	45-Deg	90-Deg
45	12336	3863	12226
55	11529	2767	11377
65	10528	1804	10269
75	8830	923	8574
85	5807	211	5553

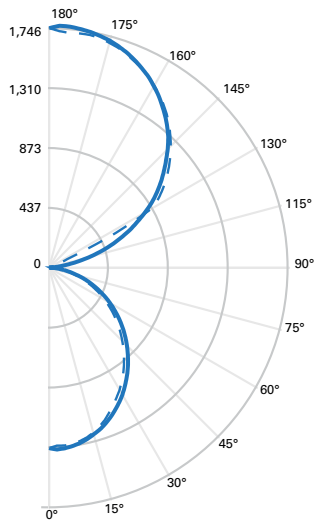

Filename: S122DIP-U2-235-SC48-SR0048-1D-UDD-1-NA-W
 Test Number: P27986
 Lumens: 8252 Lms
 Watts: 80.3 W
 LPW: 102.8 Lm/W
 CCT: 3500K

ZONAL LUMEN STUDY		
Zone	Lumens	% Fixture
0-30	985	11.9
0-40	1583	19.2
0-60	2706	32.8
0-90	3354	40.6
90-180	4898	59.4

LUMINANCE DATA (cd / sq.m)			
Angle	0-Deg	45-Deg	90-Deg
45	17760	5562	17603
55	16600	3983	16380
65	15157	2597	14783
75	12711	1328	12344
85	8348	304	7985

Discontinued
12-21-2017

LIGHT OUTPUT, 3500K, ≤85CRI Typical

Light Level Up: ULO							Light Level Up: U1							Light Level Up: U2						
Light Level	Lm Total	% Dn	% Up	Lm/ft Down	Lm/ft Up	Total Watts	Light Level	Lm Total	% Dn	% Up	Lm/ft Down	Lm/ft Up	Total Watts	Light Level	Lm Total	% Dn	% Up	Lm/ft Down	Lm/ft Up	Total Watts
	0	2495	40.6%	59.4%	299	437		26.9	0	4600	26.0%	74.0%	299		851	38.8	0	6097	19.6%	80.4%
1	4076	57.1%	42.9%	582	437	40.1	1	5732	40.6%	59.4%	582	851	52.0	1	7229	32.2%	67.8%	582	1225	65.5
2	5100	65.7%	34.3%	838	437	55.2	2	6755	49.6%	50.4%	838	851	67.0	2	8252	40.6%	59.4%	838	1225	80.5

Correlation based on 4' luminaire S122DIP-U2-235-SC48-ST0048-1D-UDD-1-NA-W, Report: P27986

Mounting Information - Refer to installation instructions for detailed mounting information

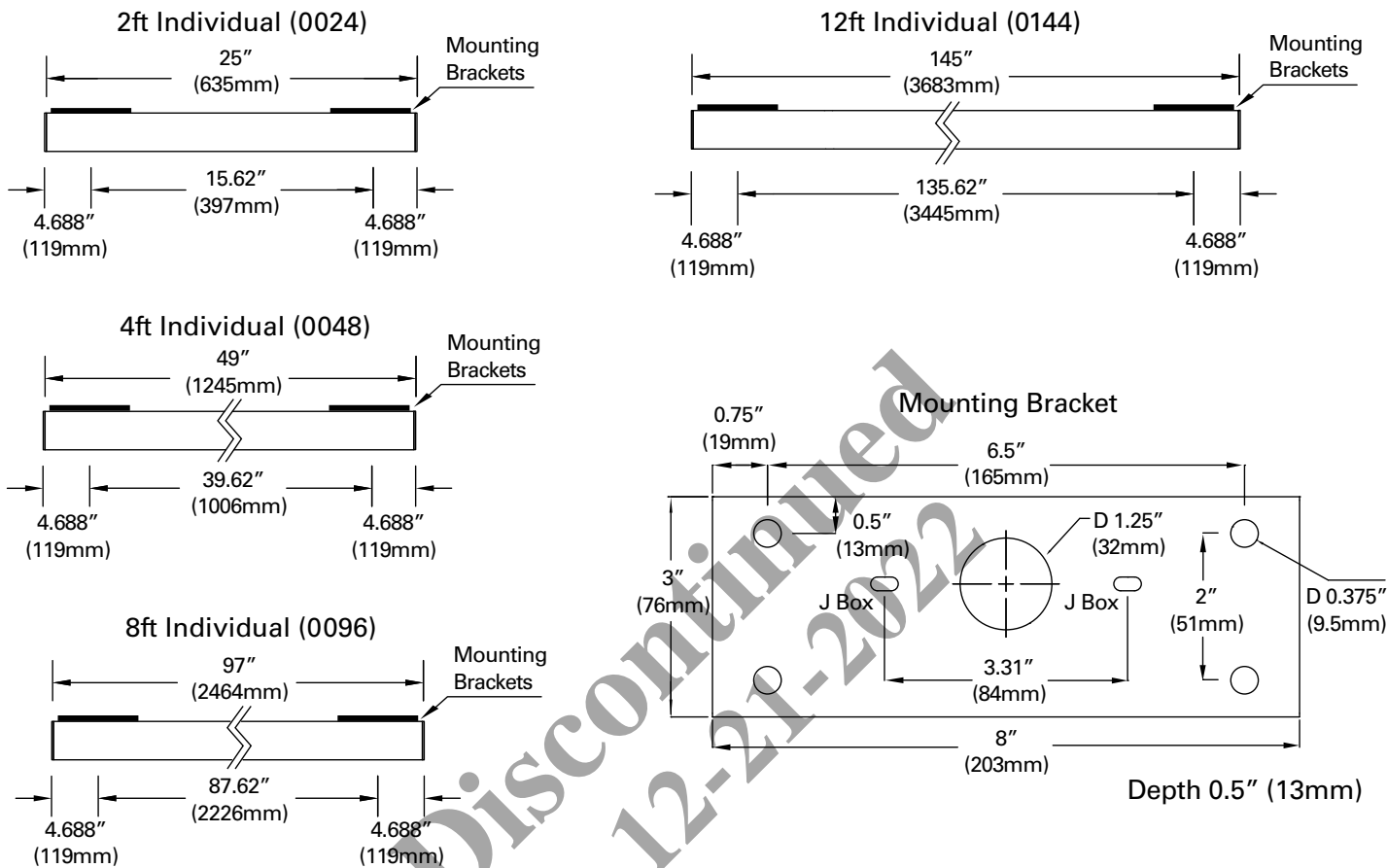

Lens Information - Direct (Downward) Lens Details

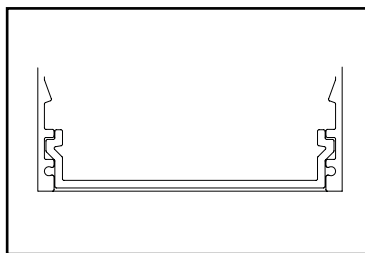

1 - Flush Satin Lens

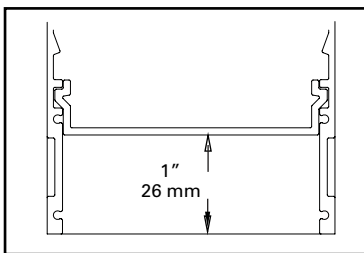

Regressed Satin Lens

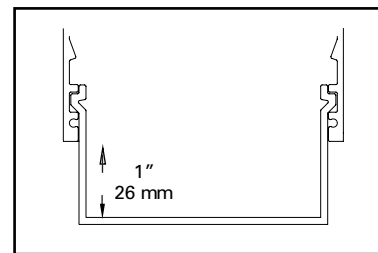

4 - Satin Drop Down Lens

Lens Information - Indirect (Upward) Lens Details

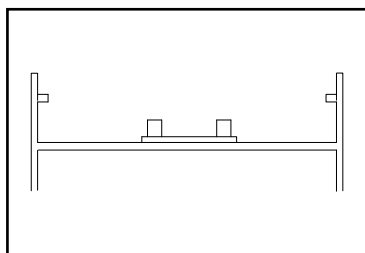

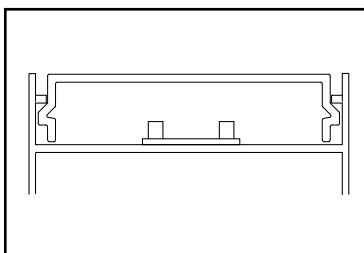

NA - No Lens (standard)



5 - Flush Satin Lens

INTEGRATED SENSOR DETAILS AND PLACEMENT¹³

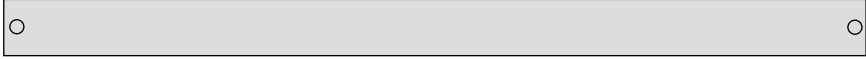
		Sensor Series		Occupancy Technology		Sensing Technology		Coverage Pattern	
4ft Individual		SV	Integrated Sensor for Local Control	P	Passive Infrared	D	Dimming Daylight Harvesting (Closed Loop)	1	~144 ft ²
8ft Individual		LWI	Lumawatt Pro Wireless Integral						
12ft Individual									

NOTES

1. Additional lower light levels available. Please consult factory for specific details.
2. Not all ceiling types are shown; consult factory for specific ceiling types not listed.
3. All lengths are nominal. Refer to submittal drawings for actual sizes.
4. Not all dimming options available for every length; please consult factory for specific details.
5. For configurable runs specify length to nearest foot. Standard runs ship in 12ft increments. Ensure to specify 8ft increments if 12ft are too large to receive. Additional charges may apply; please consult factory for details.
6. 347V is achieved using remote transformer.
7. FifthLight DALI is achieved using digital analog converter.
8. Battery pack options are not available in every length; please consult factory for specific details. Battery pack is remote installation only.
9. For all options; consult factory for specific requirements.
10. Not available with 347V circuit.
11. Asymmetric lens is not available as standard product on regressed housing RDR.
12. Standard product is configured with snap-in lens end caps at the beginning and end of a run or individual fixture. End caps are provided for ease of installation and removal of the lens and eliminate light leak from the end of the fixture when flush satin lens is selected. Please contact factory if lens end-caps are not desired as alternate configurations are available.
13. Integrated LumaWatt Pro Sensor available as a PDR in 4ft, 8ft, and 12ft configurations. Continuous runs and alternate lengths are also available. Please consult factory for details. One sensor for every 8ft of fixture length. Standard configurations include Universal voltage, single circuit and 'DD' driver selection. Not available with regressed housing or emergency options. Coverage pattern limited by proximity to wall.

Discontinued
12-21-2022