

**DESCRIPTION**

Recessed medium distribution LED open downlight luminaire with 4 inch square aperture utilizing a LED array. Modular platform can be reconfigured from below the ceiling to accept a broad range of lamp modules and optical elements. Platform is suitable for 2x6 residential or shallow plenum commercial applications. Insulation must be kept 3" from top and sides of housing. Platform + module + element combination produces square distribution with excellent light control and low aperture brightness.

<b>Catalog #</b>		<b>Type</b>
<b>Project</b>		
<b>Comments</b>		<b>Date</b>
<b>Prepared By</b>		

**SPECIFICATION FEATURES**

**Frame**

Galvanized steel plaster frame with integral bar hanger receivers. Setscrews provide positive horizontal locking.

**Collar**

Matte black aluminum collar adjusts vertically for 1/2" - 1" thick ceilings and can be rotated ± 7.5° thru the aperture. Integral gun sights facilitate the use of guide strings or laser lines. Shipped with a paint overspray protector.

**Housing**

Steel housing painted matte black for a visually dark interior. Removable hinged cover allow for top access. All fasteners are captive.

**Bar Hangers**

Captive preinstalled bar hangers adjust from 8-1/2" to 24" wide; pass thru allows shortening without removal. Captive nail penetrates standard and engineered lumber. Mounting flange levels platform with ceiling. Integral clip attaches direction to tee grid.

**Universal Mounting Bracket**

Accepts 1/2" EMT, C channel and bar hangers and adjusts 3" vertically from above the ceiling.

**Gaskets**

Closed cell gaskets achieve restrictive airflow requirements without additional caulking.

**Lamp Module**

Integral mounting clips facilitate installation from top access or thru the aperture. Locking screws (provided) lock lamp module to the housing. Electrical quick disconnect facilitates installation and field service.

**LED Array**

Field interchangeable and upgradable light engine provides a uniform source with high efficiency and no pixilation. Available in remote or proximity phosphors in various color temperatures. Select color rendering index (CRI) of 90, 95 or 97 minimum providing excellent color quality. Color accuracy within 2 SDCM.

**Primary Reflector**

Segmented Miro® upper reflector yields a smooth square beam with uniform distribution. Diffuse glass mixing dome provides shielding to source and excellent color over angle uniformity over rated life.

**Lower Reflector**

Die cast aluminum parabolic reflector is seamless and provides for 55° cutoff. Self-flanged standard; may be installed rimless with optional rimless adapter.

**Trim Retention**

Mousetrap type springs pull flange tight to ceiling. Light trap eliminates spill light at edge of flange and reflector.

**Junction Box**

(7) 1/2" trade size pry outs, (3) non-metallic cable. Listed for (8) #12 AWG (four in, four out) 90°C conductors and feed thru branch wiring. Wago® quick connects for field wiring.

**Driver**

Integral 120 or 120-277V 50/60 Hz constant current driver provides noise free operation. Continuous, flicker-free leading or trailing edge phase cut dimming from 100 to 1% with select controls.

**Compliance**

cULus listed for damp locations. UL1598 wet location labeled, covered ceiling mount only. Restrictive airflow per ASTM E283. EMI/RFI emissions per FCC 47CFR Part 15 class B limits and suitable for residential and commercial use. Contains no mercury or lead and RoHS compliant. Zhaga certified luminaire. Photometric testing in accordance with IES LM79. LED life testing in accordance with LM80.

**Warranty**

5 year warranty.



**P406TAT  
MH4LED  
E4DC**

**Medium Distribution  
LED Open Downlight**

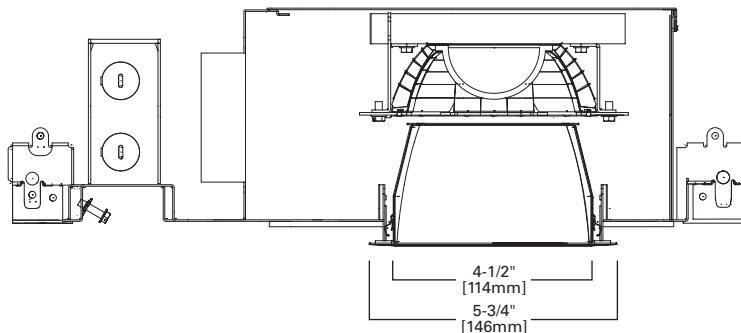
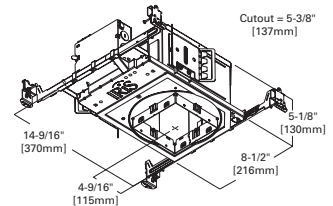

**4-Inch Square Aperture**



Refer to ENERGY STAR® Qualified Products List. Can be used to comply with California Title 24 High Efficacy requirements. Certified to California Title 20 Appliance Efficiency Database.



Cooper Lighting Solutions is a founding member of the Zhaga Consortium

Delivered Performance		V927	V930	V935	V940	D927	D930	A927	A930	
	CRI (Min)	90	90	90	90	97	97	95	95	
	R9 (Min)	50	50	50	50	95	95	90	90	
	CCT (K5)	2700	3000	3500	4000	2700	3000	2700	3000	
	SDCM	2-Step								
	Life (L70)	50,000 Hours						40,000 Hours*		
	LPW**	54	57	63	70	43	47	43	46	
	Lumens	15W	775	822	902	1015	614	672	615	656
		20W	1051	1116	1224	1376	833	912	835	890
		33W	1710	1781	1879	2198	1279	1400	1282	1366
Performance data based on goniometer measurements with 'E' driver option and E4DCMW lower shielding reflector. *Projected lumen maintenance. **LPW based on 15W and 'E' driver option.										

**ORDERING INFORMATION**

(Order housing platform, lamp module and optical element separately)

Platform	Accessories
<p><b>P406TAT</b> = 4" square housing platform, non-IC, airtight  <b>P406TCP</b> = 4" square housing platform, non-IC, CCEA listed for City of Chicago plenum requirements</p>	<p><b>RA4X4</b> = Rimless adapter for 4" housing platforms  <b>EDC4X41</b> = Extended depth collar for 1" - 1-1/2" thick ceilings  <b>EDC4X42</b> = Extended depth collar for 1-1/2" - 2" thick ceilings  <b>L4X4HEX</b> = Matte black hex cell louver</p>

Lamp Module	Wattage	Light Engine	Driver
<p><b>MH4LED</b> = 4" square LED module</p>	<p><b>15</b> = 15 Watts  <b>20</b> = 20 Watts  <b>33</b> = 33 Watts</p>	<p><b>V927</b> = Bridgelux Vero Series, Zhaga certified, 90 CRI min, 2700 K CCT  <b>V930</b> = Bridgelux Vero Series, Zhaga certified, 90 CRI min, 3000 K CCT  <b>V935</b> = Bridgelux Vero Series, Zhaga certified, 90 CRI min, 3500 K CCT  <b>V940</b> = Bridgelux Vero Series, Zhaga certified, 90 CRI min, 4000 K CCT  <b>D927</b> = Bridgelux Décor Series, Zhaga certified, 97 CRI min, 2700 K CCT  <b>D930</b> = Bridgelux Décor Series, Zhaga certified, 97 CRI min, 3000 K CCT  <b>A927</b> = Xicato XTM Artist Series, Zhaga compatible, 95 CRI min, 2700 K CCT  <b>A930</b> = Xicato XTM Artist Series, Zhaga compatible, 95 CRI min, 3000 K CCT</p>	<p><b>E</b> = 120 - 277V 50/60 Hz LE/TE phase cut dimming to 1% (dimming at 120V input only, available in 15 and 20 watt only)  <b>1ELTE</b> = 120V 60 Hz LE phase cut dimming to 1%, Lutron A-Series</p>

Element	Texture	Finish	Flange Style
<p><b>E4DC</b> = 4" Open Die Cast Reflector</p>	<p>[Blank] = Smooth</p>	<p><b>Painted Finishes</b>  <b>MB</b> = Matte Black  <b>MW</b> = Matte White  <b>W</b> = Gloss White  <b>MMS</b> = Matte Metallic Silver</p>	<p>[Blank] = Self-flanged  <b>RL</b> = Rimless, Use with Rimless Adapter</p>

WIRING DIAGRAM

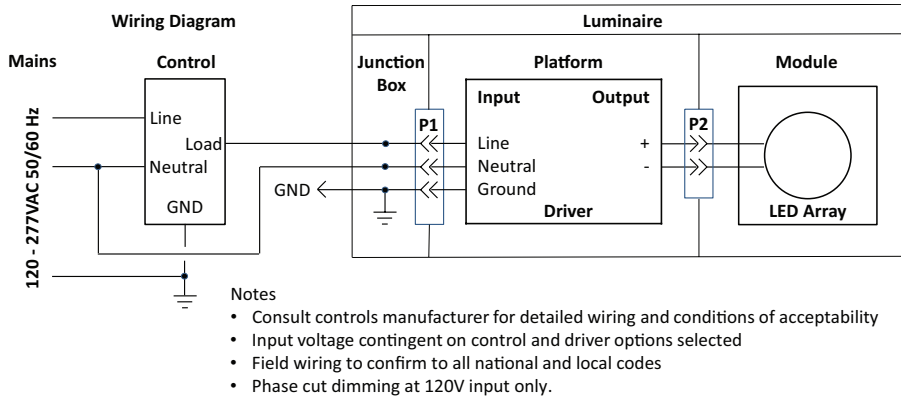

ENERGY

ENERGY DATA			
E = LE & TE Phase Cut			
Input Voltage	120V	277V	
15W	Input Power (W)	14.4	15.4
	Input Current (A)	0.121	0.059
	Inrush (A)	0.16	0.288
20W	Input Power (W)	21.2	21.8
	Input Current (A)	0.178	0.082
	Inrush (A)	0.218	0.403
T Ambient -40 - +40°C			
Power Factor ≥ 0.90			
Sound Rating Class A			
THD ≤ 20%			

COMPATIBLE CONTROLS

Manufacturer	Series	Model	15W				LE Start Time	20W				LE Start Time
			Minimum Luminaires (per Circuit)	Maximum Luminaires (per Circuit)	Minimum Measured Light Output	Maximum Measured Light Output		Maximum Luminaires (per Circuit)	Minimum Measured Light Output (per Circuit)	Maximum Measured Light Output	Minimum Luminaires	
Lutron	Ariadni	AY-600P	1	37	9%	98%	<1s	1	27	11%	98%	<1s
Lutron	Contour	CT103P	1	62	1%	98%	>1s	1	45	4%	98%	<1s
Lutron	Contour	CT-600P	1	37	1%	98%	>1s	1	27	3%	98%	<1s
Lutron	Rotary	D-600P	1	37	1%	98%	>1s	1	27	3%	98%	>1s
Lutron	Diva	DV-600P	1	37	1%	98%	>1s	1	27	2%	98%	<1s
Lutron	Glyder	GL-600P	1	37	2%	99%	<1s	1	27	7%	98%	<1s
Lutron	Lumia	LG-600PH	1	37	1%	98%	>1s	1	27	1%	98%	>1s
Lutron	Nova	N-600	1	37	0%	99%	>1s	1	27	1%	99%	<1s
Lutron	Skylark	S-600P	1	37	1%	98%	>1s	1	27	1%	98%	>1s
Lutron	Centurion	C-600P	1	37	3%	99%	>1s	1	27	5%	99%	>1s
Lutron	Ariadni	AYLV-600P	1	28	4%	98%	<1s	1	20	9%	98%	<1s
Lutron	Glyder	GLV600	1	28	1%	99%	<1s	1	20	3%	99%	<1s
Lutron	Diva	DVLV-600P	1	28	2%	97%	<1s	1	20	6%	98%	<1s
Lutron	Lumina	LG-103P	1	62	5%	98%	<1s	1	45	10%	98%	<1s
Lutron	Skylark	SLV-600P	1	28	1%	98%	>1s	1	20	3%	98%	>1s
Lutron	Nova	NTLV600	1	28	9%	99%	<1s	1	20	12%	99%	<1s
Lutron	Nova	NT600	1	37	2%	99%	>1s	1	27	4%	99%	>1s

## COMPATIBLE CONTROLS

Manufacturer	Series	Model	15W		Minimum Measured Light Output	Maximum Measured Light Output	LE Start Time	20W		Minimum Measured Light Output	Maximum Measured Light Output	LE Start Time
			Minimum Luminaires (per Output)	Maximum Luminaires (per Output)				Minimum Luminaires (per Output)	Maximum Luminaires (per Output)			
Lutron	Maestro	MACL-153M(_)*	1	10	20%	98%	<1s	-	-	-	-	-
Lutron	Maestro Wireless	MRF2-6ND	1	10	20%	99%	>1s	1	7	19%	100%	>1s
Lutron	Maestro Wireless	MRF2-6ELV	-	-	-	-	-	1	7	19%	100%	>1s
Lutron	RadioRA2 1000 W	RRD-10ND	1	10	20%	99%	>1s	1	7	19%	100%	>1s
Lutron	RadioRA2 Adaptive Dimmer	RRD-6NA	-	-	-	-	-	1	7	19%	100%	>1s
Lutron	HomeWorks QS 600 W	HQRD-6ND	1	10	20%	99%	>1s	1	7	19%	100%	>1s
Lutron	HomeWorks QS 1000 W	HQRD-10ND	1	10	20%	99%	>1s	1	7	19%	100%	>1s
Lutron	HomeWorks QS Adaptive Dimmer	HQRD-6NA	-	-	-	-	-	1	7	19%	100%	>1s
Lutron	HomeWorks 600 W Dimmer	HxD-6ND	1	23	19%	99%	>1s	1	15	20%	99%	>1s
Lutron	"Grafik Eye 3000/ HomeWorks"	"Grafik Eye 3000 Family/ HWI-WPM-6D-120"	1	35	20%	98%	>1s	1	22	20%	100%	>1s
Lutron	"Grafik QS/ Wallbox Power Module"	"Grafik Eye QS Main Unit Family/ LQRJ-WPM-6P"	1	35	20%	98%	>1s	1	22	20%	100%	>1s
Lutron	RPM-4U Module (LCP, HomeWorks, GRAFIK Systems, Quantum)	HW-RPM-4U-120, LP-RPM-4U-120	1	86	20%	96%	>1s	1	55	18%	97%	>1s
Lutron	RPM-4A Module (LCP, HomeWorks, GRAFIK Systems, Quantum)	HW-RPM-4A-120, LP-RPM-4A-120	1	53	19%	99%	>1s	1	34	19%	98%	>1s
Lutron	Panel module	GP (Harrier) Card	-	-	-	-	-	1	50	19%	97%	>1s
Lutron	Stanza	SZ-6ND	1	23	19%	99%	>1s	1	15	20%	99%	>1s
Lutron		"PHPM-PA with Grafik Eye QS Main Unit"	1	71	19%	98%	>1s	1	55	20%	99%	>1s
Lutron		"PHPM-WBX with 3-wire fluorescent control"	1	71	19%	98%	>1s	1	55	20%	99%	>1s

COMPATIBLE CONTROLS

Manufacturer	Series	Model	15W		Maximum Measured	Minimum Measured	LE Start Time(s)	20W		Maximum Measured	Minimum Measured	LE Start Time(s)
			Minimum Luminaires (per circuit)	Maximum Luminaires (per circuit)				Minimum Luminaires	Maximum Luminaires			
Vantage	Enclosure Module	SDM12 EM	1	25	96.1%	1.7%	3.4s	1	17	95.9%	0.2%	5s
Vantage	Enclosure Module	EDIMMOD	1	37	98.8%	3.8%	2.4s	1	25	95.8%	4.9%	1.9s
Vantage	ScenePoint	DS / RD	1	8	96.1%	1.7%	3.4s	1	7	95.9%	0.2%	5s
Vantage	RFLC	DRD4	1	8	100%	6.3%	2.3s	1	7	100%	8.4%	1.9s
Crestron	Green Light	GLX-DIM6	--	--	100%	15%	--	--	--	100%	9%	--
Crestron	Green Light	GLXX-2DIM8	--	--	100%	15%	--	--	--	100%	9%	--
Crestron	Green Light	CLS-EXP-DIMU	--	--	100%	8%	--	--	--	100%	11%	--
Crestron	Green Light	DIN-1DIM4	--	--	100%	6%	--	--	--	100%	7%	--
Crestron	Green Light	DIN-1DIMU4	--	--	100%	14%	--	--	--	100%	9%	--
Savant		LMD-4120	--	--	100%	3.5%	<1s	--	--	100%	2.7%	<1s
Savant		LMD-8120	--	--	100%	10.1%	<1s	--	--	100%	10.4%	<1s
Savant		LMD-IN120	--	--	100%	3.5%	<1s	--	--	100%	3.1%	<1s

Manufacturer	Series	Model	15W		Maximum Measured	Minimum Measured	LE Start Time	20W		Maximum Measured	Minimum Measured	LE Start Time
			Minimum Luminaires (per circuit)	Maximum Luminaires (per circuit)				Minimum Luminaires	Maximum Luminaires			
CWD	Ilumen	SC277-06-UN	1	38	100%	13%	<1s	1	28	99.40%	16.58%	<1s
CWD	Aspire	9530AW	1	30	100%	5%	<1s	1	21	100.00%	13.07%	<1s
CWD	Skye	DE06P	1	30	98%	11%	<1s	1	21	96.78%	14.81%	<1s
CWD	Devine	RI061	1	30	99%	21%	>1s	1	21	98.81%	24.23%	>1s
CWD	Devine	TAL06P	1	37	100%	10%	<1s	1	27	99.22%	11.91%	<1s
CWD	Toggle	DAL06P	1	37	100%	4%	<1s	1	27	99.16%	5.66%	<1s
CWD	Skye	SAL06P	1	37	100%	9%	<1s	1	27	99.16%	13.00%	<1s
CWD	Skye	SLC06P	1	37	99%	2%	>1s	1	27	98.27%	1.76%	>1s
CWD	Devine	DLC06P	1	18	99%	2%	>1s	1	13	98.57%	3.09%	<1s
CWD	Toggle	TI061	1	30	97%	5%	<1s	1	21	96.36%	12.58%	<1s
CWD	Smart	AAL06	1	37	99%	10%	<1s	1	27	98.51%	13.33%	<1s

WIRING DIAGRAM

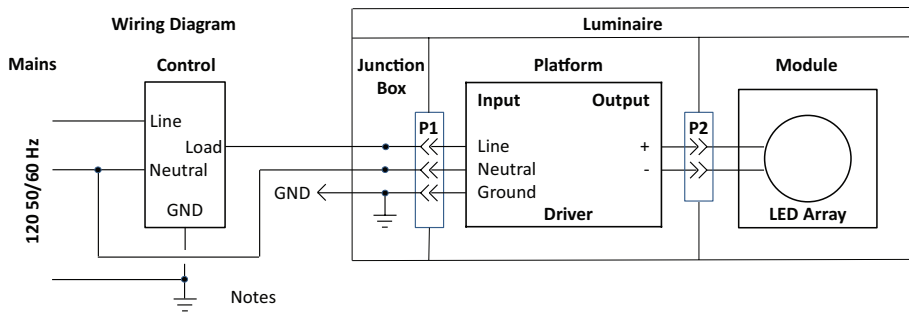

- Notes
- Consult controls manufacturer for detailed wiring and conditions of acceptability
  - Input voltage contingent on control and driver options selected
  - Field wiring to confirm to all national and local codes

ENERGY

ENERGY DATA		
1ELTE = LE Phase Cut		
Input Voltage	120V	
15W	Input Power (W)	16.3
	Input Current (A)	0.14
	Inrush (A)	1.128
20W	Input Power (W)	23.2
	Input Current (A)	0.195
	Inrush (A)	1.112
33W	Input Power (W)	33.7
	Input Current (A)	0.283
	Inrush (A)	0.072
T Ambient -40 - +40°C		
Power Factor ≥ 0.90		
Sound Rating Class A		
THD ≤ 20%		

Discontinued  
09-20-2021

COMPATIBLE CONTROLS

Manufacturer	Series	Model	15W		Maximum Measured	Minimum Measured	LE Start Time	20W		Maximum Measured	Minimum Measured	LE Start Time	33W		Maximum Measured	Minimum Measured	LE Start Time
			Minimum Luminaires	Maximum Luminaires				Minimum Luminaires	Maximum Luminaires				Minimum Luminaires	Maximum Luminaires			
Lutron	Nova T	NTLV-600-CPN0199	1	8	100%	1%	<1s	1	8	100%	1%	<1s	1	8	100%	1%	<1s
Lutron	Maestro Wireless	MRF2-6ND-120	1	8	100%	1%	<1s	1	8	100%	1%	<1s	1	8	100%	1%	<1s
Lutron	RadioRA2 1000 W	RRD-10ND	1	13	100%	1%	<1s	1	13	100%	1%	<1s	1	13	100%	1%	<1s
Lutron	RadioRA2 Adaptive Dimmer	RRD-6NA	1	8	100%	1%	<1s	1	8	100%	1%	<1s	1	8	100%	1%	<1s
Lutron	RadioRA 600 W	RA-6ND	1	8	100%	1%	<1s	1	8	100%	1%	<1s	1	8	100%	1%	<1s
Lutron	RadioRA 1000 W	RA-10ND	1	13	100%	1%	<1s	1	13	100%	1%	<1s	1	13	100%	1%	<1s
Lutron	HomeWorks QS 600 W	HQRD-6ND	1	8	100%	1%	<1s	1	8	100%	1%	<1s	1	8	100%	1%	<1s
Lutron	HomeWorks QS 1000 W	HQRD-10ND	1	13	100%	1%	<1s	1	13	100%	1%	<1s	1	13	100%	1%	<1s
Lutron	HomeWorks QS Adaptive Dimmer	HQRD-6NA	1	8	100%	1%	<1s	1	8	100%	1%	<1s	1	8	100%	1%	<1s
Lutron	HomeWorks QS WPM	HQRJ-WPM-6D-120	1	10	100%	1%	<1s	1	10	100%	1%	<1s	1	10	100%	1%	<1s
Lutron	HomeWorks 600 W Dimmer	HRD-6ND	1	8	100%	1%	<1s	1	8	100%	1%	<1s	1	8	100%	1%	<1s
Lutron	HomeWorks 1000 W dimmer	HWD-10ND, HRD-10ND	1	8	100%	1%	<1s	1	8	100%	1%	<1s	1	8	100%	1%	<1s
	HomeWorks WPM	HWI-WPM-6D-120	1	10	100%	1%	<1s	1	10	100%	1%	<1s	1	10	100%	1%	<1s
Lutron	GRAFIK Eye QS	QSGR-, QSGRJ-	1	10	100%	1%	<1s	1	10	100%	1%	<1s	1	10	100%	1%	<1s
	GRAFIK Eye 3000	GRX-3100, GRX-3500	1	10	100%	1%	<1s	1	10	100%	1%	<1s	1	10	100%	1%	<1s
Lutron	RPM-4U Module (LCP, HomeWorks,	HW-RPM-4U-120,	1	26	100%	1%	<1s	1	26	100%	1%	<1s	1	26	100%	1%	<1s
	GRAFIK Systems, Quantum)	LP-RPM-4U-120															
Lutron	RPM-4A Module (LCP, HomeWorks,	HW-RPM-4A-120,	1	13	100%	1%	<1s	1	13	100%	1%	<1s	1	13	100%	1%	<1s
	GRAFIK Systems, Quantum)	LP-RPM-4A-120															
Lutron	GP Panels	Various	1	26	100%	1%	<1s	1	26	100%	1%	<1s	1	26	100%	1%	<1s
Lutron	Stanza	SZ-6ND	1	8	100%	1%	<1s	1	8	100%	1%	<1s	1	8	100%	1%	<1s
Lutron	"Ariadni® C•L® 250 W dimmer"	AYCL-253P-	1	8	100%	1%	<1s	1	8	100%	1%	<1s	1	8	100%	1%	<1s
Lutron	"Diva® C•L® 250 W dimmer"	DVCL-253P- S	1	8	100%	1%	<1s	1	8	100%	1%	<1s	1	8	100%	1%	<1s
		DVSCCL-253P	1	8	100%	1%	<1s	1	8	100%	1%	<1s	1	8	100%	1%	<1s

COMPATIBLE CONTROLS

Manufacturer	Series	Model	15W		Maximum Measured	Minimum Measured	LE Start Time	20W		Maximum Measured	Minimum Measured	LE Start Time	33W		Maximum Measured	Minimum Measured	LE Start Time
			Minimum Luminaires	Maximum Luminaires				Minimum Luminaires	Maximum Luminaires				Minimum Luminaires	Maximum Luminaires			
Vantage	Enclosure Module	SDM12 EM	1	21	95.1%	1.0%	1.90s	1	17	95.3%	1.0%	1.70s	1	17	98.7%	1.1%	1.7s
Vantage	Enclosure Module	EDIMMOD	1	31	95.8%	0.9%	1.90s	1	25	96.2%	1.0%	1.80s	1	30	95.8%	1.1%	2.2s
Vantage	ScenePoint	DS / RD	1	7	95.1%	1.0%	1.90s	1	4	95.3%	1.0%	1.70s	1	7	98.7%	1.1%	1.7s
Crestron	Green Light	GLX-DIM6	--	--	100%	1%	--	--	--	100%	1%	--	--	--	100%	1%	--
Crestron	Green Light	CLX-2DIM8	--	--	100%	1%	--	--	--	100%	1%	--	--	--	100%	1%	--
Crestron	Green Light	GLXX-2DIM8	--	--	100%	1%	--	--	--	100%	1%	--	--	--	100%	1%	--
Crestron	Green Light	CLS-EXP-DIM	--	--	100%	1%	--	--	--	100%	1%	--	--	--	100%	1%	--
Crestron	Green Light	CLS-C6	--	--	100%	1%	--	--	--	100%	1%	--	--	--	100%	1%	--
Crestron	Green Light	CLW-DIMEX	--	--	100%	1%	--	--	--	100%	1%	--	--	--	100%	1%	--
Crestron	Green Light	CLX-1DELV4	--	--	100%	1%	--	--	--	100%	1%	--	--	--	100%	1%	--
Crestron	Green Light	DIN-1DIMU4	--	--	100%	1%	--	--	--	100%	1%	--	--	--	100%	1%	--
Cooper Lighting Solutions	ilumin	SC277-06-UN-1P	1	38	99%	0%	>1s	1	28	99%	0%	<1s	1	17	100	1%	<1s
Savant	--	LMD-8120	--	--	100%	3.0%	<1s	--	--	100%	3.0%	<1s	--	--	100%	2%	<1s
Savant	--	LMD-IN120	--	--	100%	4.0%	<1s	--	--	100%	4.0%	<1s	--	--	100%	2%	<1s
Savant	--	WCD-101xx	--	--	100%	3%	<1s	--	--	100%	0.03	<1s	--	--	1	2%	<1s

FINISH MULTIPLIERS

	MB	MW	W	MMS
[Blank] = Smooth	0.76	1.04	1.04	0.82

LIGHTING FACTS

**LED lighting facts**  
A Program of the U.S. DOE

Light Output (Lumens) **822**  
Watts **14.46**  
Lumens per Watt (Efficacy) **56.85**

Color Accuracy **90**  
Color Rendering Index (CRI)

Light Color **3000 (Bright White)**  
Correlated Color Temperature (CCT)

2700K 3000K 4500K 6500K

All results are according to IESNA LM-79-2008: Approved Method for the Electrical and Photometric Testing of Solid-State Lighting. The U.S. Department of Energy (DOE) verifies product test data and results.

Visit [www.lightingfacts.com](http://www.lightingfacts.com) for the Label Reference Guide.

Registration Number: F4QJ-DBYTUE (8/25/2015)  
Model Number: P406TAT MH4LED15V930E E4DCMW [Upgrade : 9/25/2015]  
Type: Luminaire - Downlight

**LED lighting facts**  
A Program of the U.S. DOE

Light Output (Lumens) **650**  
Watts **15**  
Lumens per Watt (Efficacy) **43.33**

Color Accuracy **97**  
Color Rendering Index (CRI)

Light Color **3000 (Bright White)**  
Correlated Color Temperature (CCT)

2700K 3000K 4500K 6500K

All results are according to IESNA LM-79-2008: Approved Method for the Electrical and Photometric Testing of Solid-State Lighting. The U.S. Department of Energy (DOE) verifies product test data and results.

Visit [www.lightingfacts.com](http://www.lightingfacts.com) for the Label Reference Guide.

Registration Number: F4QJ-L8BAVT (7/27/2015)  
Model Number: P406TAT MH4LED15D930E E4DCMW  
Type: Luminaire - Downlight

**LED lighting facts**  
A Program of the U.S. DOE

Light Output (Lumens) **698**  
Watts **13**  
Lumens per Watt (Efficacy) **53.74**

Color Accuracy **97**  
Color Rendering Index (CRI)

Light Color **2953 (Warm White)**  
Correlated Color Temperature (CCT)

2700K 3000K 4500K 6500K

All results are according to IESNA LM-79-2008: Approved Method for the Electrical and Photometric Testing of Solid-State Lighting. The U.S. Department of Energy (DOE) verifies product test data and results.

Visit [www.lightingfacts.com](http://www.lightingfacts.com) for the Label Reference Guide.

Registration Number: F4QJ-PY16RH (7/30/2015)  
Model Number: P406TAT MH4LED15A930E E4DCMW  
Type: Luminaire - Downlight

PHOTOMETRICS

Test Number	P128321
Platform	P406TAT
Element	MH4LED15V930E E4DCMW
Lumens	822
Efficacy	57.1 Lm/W
SC	1.19

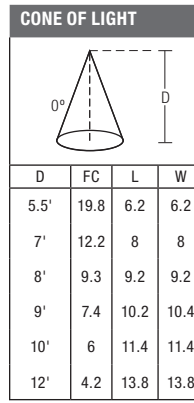
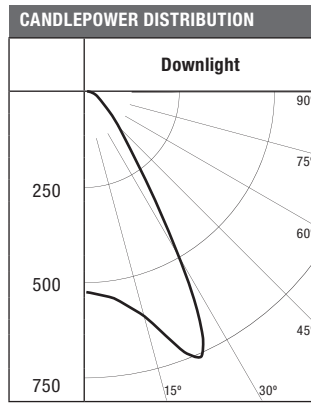
**CANDELA TABLE**

Degrees Vertical	Candela
0	527
5	536
15	618
25	728
35	242
45	107
55	53
65	34
75	18
85	5
90	0

**ZONAL LUMEN SUMMARY**

Zone	Lumens	%Fixture
0-30	488	59.3
0-40	643	78.1
0-60	764	92.9
0-90	822	100
90-180	0	0
0-180	822	100

**COEFFICIENTS OF UTILIZATION**

Ceiling Wall % RCR	80%				70%				50%	
	70	50	30	10	50	30	10	50	10	
Zonal cavity method -- floor reflectance = 20%										
0	119	119	119	119	116	116	116	111	111	
1	112	108	105	102	106	103	101	102	98	
2	105	99	94	90	97	92	89	94	87	
3	98	91	85	80	89	84	79	86	78	
4	92	83	77	72	82	76	71	80	70	
5	87	77	70	65	76	70	65	74	64	
6	82	72	65	60	71	64	60	69	59	
7	78	67	60	55	66	60	55	65	55	
8	73	63	56	51	62	56	51	61	51	
9	70	59	52	48	58	52	48	57	47	
10	66	55	49	45	55	49	45	54	44	

Test Number	P128655
Platform	P406TAT
Element	MH4LED20V930E E4DCMW
Lumens	1116
Efficacy	52.4 Lm/W
SC	1.19

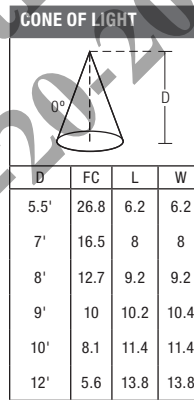
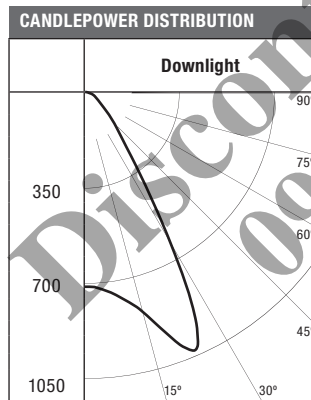
**CANDELA TABLE**

Degrees Vertical	Candela
0	715
5	727
15	838
25	988
35	328
45	145
55	72
65	46
75	24
85	7
90	0

**ZONAL LUMEN SUMMARY**

Zone	Lumens	%Fixture
0-30	662	59.3
0-40	872	78.1
0-60	1037	92.9
0-90	1116	100
90-180	0	0
0-180	1116	100

**COEFFICIENTS OF UTILIZATION**

Ceiling Wall % RCR	80%				70%				50%	
	70	50	30	10	50	30	10	50	10	
Zonal cavity method -- floor reflectance = 20%										
0	119	119	119	119	116	116	116	111	111	
1	112	108	105	102	106	103	101	102	98	
2	105	99	94	90	97	92	89	94	87	
3	98	91	85	80	89	84	79	86	78	
4	92	83	77	72	82	76	71	80	70	
5	87	77	70	65	76	70	65	74	64	
6	82	72	65	60	71	64	60	69	59	
7	78	67	60	55	66	60	55	65	55	
8	73	63	56	51	62	56	51	61	51	
9	70	59	52	48	58	52	48	57	47	
10	66	55	49	45	55	49	45	54	44	

PHOTOMETRICS

Test Number	P167732
Platform	P406TAT
Element	MH4LED33V9301ELTEE4DCMW
Lumens	1781
Efficacy	48.6 Lm/W
SC	1.19

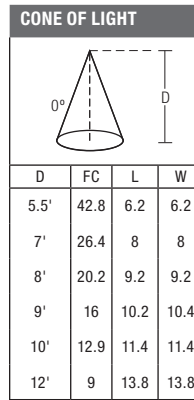
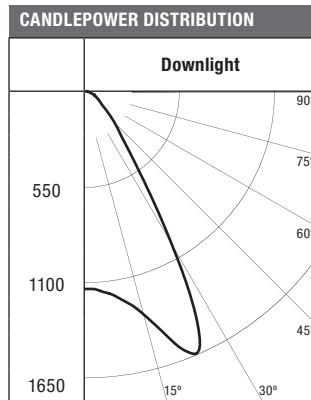
**CANDELA TABLE**

Degrees Vertical	Candela
0	1142
5	1162
15	1339
25	1578
35	523
45	231
55	115
65	73
75	38
85	11
90	0

**ZONAL LUMEN SUMMARY**

Zone	Lumens	%Fixture
0-30	1057	59.3
0-40	1392	78.1
0-60	1656	92.9
0-90	1781	100
90-180	0	0
0-180	1781	100

**COEFFICIENTS OF UTILIZATION**

Ceiling Wall % RCR	80%				70%				50%	
	70	50	30	10	50	30	10	50	10	
	Zonal cavity method -- floor reflectance = 20%									
0	119	119	119	119	116	116	116	111	111	
1	112	108	105	102	106	103	101	102	98	
2	105	99	94	90	97	92	89	94	87	
3	98	91	85	80	89	84	79	86	78	
4	92	83	77	72	82	76	71	80	70	
5	87	77	70	65	76	70	65	74	64	
6	82	72	65	60	71	64	60	69	59	
7	78	67	60	55	66	60	55	65	55	
8	73	63	56	51	62	56	51	61	51	
9	70	59	52	48	58	52	48	57	47	
10	66	55	49	45	55	49	45	54	44	

Test Number	P128325
Platform	P406TAT
Element	MH4LED15D930E E4DCMW
Lumens	672
Efficacy	46.7 Lm/W
SC	1.19

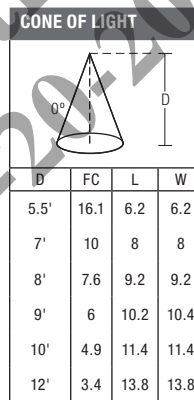
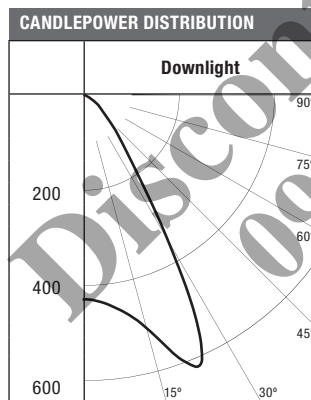
**CANDELA TABLE**

Degrees Vertical	Candela
0	431
5	438
15	505
25	595
35	197
45	87
55	43
65	28
75	14
85	4
90	0

**ZONAL LUMEN SUMMARY**

Zone	Lumens	%Fixture
0-30	399	59.3
0-40	525	78.1
0-60	625	92.9
0-90	672	100
90-180	0	0
0-180	672	100

**COEFFICIENTS OF UTILIZATION**

Ceiling Wall % RCR	80%				70%				50%	
	70	50	30	10	50	30	10	50	10	
	Zonal cavity method -- floor reflectance = 20%									
0	119	119	119	119	116	116	116	111	111	
1	112	108	105	102	106	103	101	102	98	
2	105	99	94	90	97	92	89	94	87	
3	98	91	85	80	89	84	79	86	78	
4	92	83	77	72	82	76	71	80	70	
5	87	77	70	65	76	70	65	74	64	
6	82	72	65	60	71	64	60	69	59	
7	78	67	60	55	66	60	55	65	55	
8	73	63	56	51	62	56	51	61	51	
9	70	59	52	48	58	52	48	57	47	
10	66	55	49	45	55	49	45	54	44	

PHOTOMETRICS

Test Number	P128659
Platform	P406TAT
Element	MH4LED20D930E E4DCMW
Lumens	912
Efficacy	42.8 Lm/W
SC	1.19

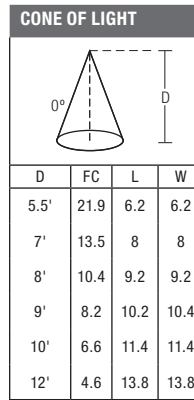
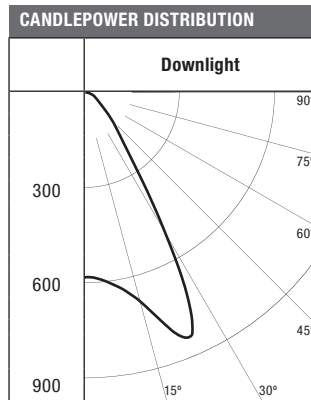
**CANDELA TABLE**

Degrees Vertical	Candela
0	585
5	594
15	685
25	808
35	268
45	118
55	59
65	38
75	20
85	6
90	0

**ZONAL LUMEN SUMMARY**

Zone	Lumens	%Fixture
0-30	541	59.3
0-40	712	78.1
0-60	847	92.9
0-90	912	100
90-180	0	0
0-180	912	100

**COEFFICIENTS OF UTILIZATION**

Ceiling Wall % RCR	80%				70%				50%	
	70	50	30	10	50	30	10	50	10	
Zonal cavity method -- floor reflectance = 20%										
0	119	119	119	119	116	116	116	111	111	
1	112	108	105	102	106	103	101	102	98	
2	105	99	94	90	97	92	89	94	87	
3	98	91	85	80	89	84	79	86	78	
4	92	83	77	72	82	76	71	80	70	
5	87	77	70	65	76	70	65	74	64	
6	82	72	65	60	71	64	60	69	59	
7	78	67	60	55	66	60	55	65	55	
8	73	63	56	51	62	56	51	61	51	
9	70	59	52	48	58	52	48	57	47	
10	66	55	49	45	55	49	45	54	44	

Test Number	P167736
Platform	P406TAT
Element	MH4LED33D9301ELTEE4DCMW
Lumens	1400
Efficacy	38.2 Lm/W
SC	1.19

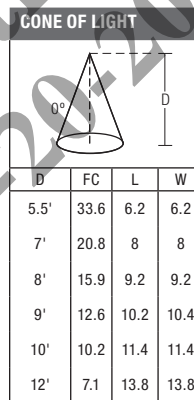
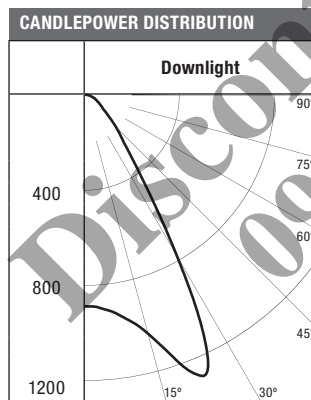
**CANDELA TABLE**

Degrees Vertical	Candela
0	898
5	913
15	1052
25	1240
35	411
45	182
55	90
65	58
75	30
85	9
90	0

**ZONAL LUMEN SUMMARY**

Zone	Lumens	%Fixture
0-30	830	59.3
0-40	1094	78.1
0-60	1301	92.9
0-90	1400	100
90-180	0	0
0-180	1400	100

**COEFFICIENTS OF UTILIZATION**

Ceiling Wall % RCR	80%				70%				50%	
	70	50	30	10	50	30	10	50	10	
Zonal cavity method -- floor reflectance = 20%										
0	119	119	119	119	116	116	116	111	111	
1	112	108	105	102	106	103	101	102	98	
2	105	99	94	90	97	92	89	94	87	
3	98	91	85	80	89	84	79	86	78	
4	92	83	77	72	82	76	71	80	70	
5	87	77	70	65	76	70	65	74	64	
6	82	72	65	60	71	64	60	69	59	
7	78	67	60	55	66	60	55	65	55	
8	73	63	56	51	62	56	51	61	51	
9	70	59	52	48	58	52	48	57	47	
10	66	55	49	45	55	49	45	54	44	