

Project		Catalog #		Type	
Prepared by		Notes		Date	



PrentaLux

205

Integral LED Light Engine
Performance Decorative

Typical Applications

• Office • Education • Healthcare • Hospitality • Retail • National Accounts

Interactive Menu

- Order Information page 2
- Product Specifications & Colors page 3
- Textures page 4
- Mounting page 4
- Lumen Maintenance & Photometric Data page 5
- Lumen/Wattage/LPW & UGR Data page 5

Certifications



Filament only.
See page 6



LIVING BUILDING CHALLENGE

Features



Awards



Top Product Features

- The PrentaLux 200 series of performance decorative fixtures utilizes Cooper Lighting's proprietary 3D printing technology process.
- Integral LED light engine with 8 Light Levels ranging from nominal 1000 to 7000 lumens.
- Designed to promote a sustainable future.
- 3 outer shade texture options and 3 distinct inner shade texture options.
- 9 standard opaque outer shade color options and 3 opaque inner shade color options with additional On-Demand colors available.
- 90+ CRI standard with 4 CCT options (2700K, 3000K, 3500K, 4000K)
- Universal Voltage (120-277V)
- 0-10V integral driver with dimming from 100% to 1%
- [Declare compliant](#)
- LBC Red List Approved
- 5-year limited warranty

Dimensions

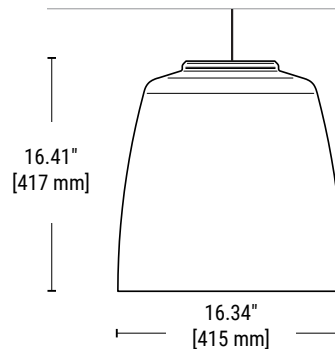

Scale

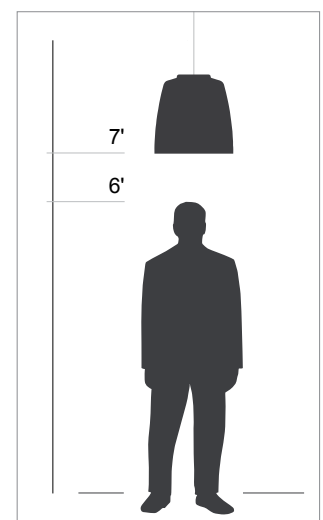

Order Information

SAMPLE CATALOG NUMBER: PRLX-205-935-LL5-C-U-S-GRAY-LF-WHHR-BR-DW

Domestic Preferences	Brand	Series	CRI	Light Level ²	Optics, Lens
[Blank] = Standard BAA = Buy America Act	PRLX	205	927 = 90 CRI, 2700K 930 = 90 CRI, 3000K 935 = 90 CRI, 3500K 940 = 90 CRI, 4000K	LL1 = 1129 lms (at 3500K, 90CRI), 10W LL2 = 1608 lms (at 3500K, 90CRI), 13W LL3 = 2190 lms (at 3500K, 90CRI), 18W LL4 = 2857 lms (at 3500K, 90CRI), 24W LL5 = 3993 lms (at 3500K, 90CRI), 34W LL6 = 4547 lms (at 3500K, 90CRI), 40W LL7³ = 5874 lms (at 3500K, 90CRI), 56W LL8³ = 6807 lms (at 3500K, 90CRI), 73W	C = Standard (84 deg), Clear Lens F^{1,2} = Standard (84 deg), Frosted Lens
1. Only product configurations with this designated prefix are built to be compliant with the Buy American Act of 1933 (BAA). Please refer to DOMESTIC PREFERENCES website for more information. Components shipped separately may be separately analyzed under domestic preference requirements.	Notes	Notes	Notes	Notes 1. Lumen targets above are based on 90 CRI and 3500K values. Use IES files for accurate calculations. 2. See Lumen Table on Page 5 for exact CCT to Lumen table values. 3. Standard Clear Lens only. Not available with Frosted Lens	Notes 1. Frosted lens will decrease delivered lumen output. Contact factory for details 2. Not available with LL7 and LL8

Continue here to make complete selections

Voltage	Dimming	Outer Shade Color ¹	Outer Shade Texture
U = Universal Voltage (120-277V)	S = 0-10V (dimming from 100% to 1%)	Standard Opaque Outer Shade Colors: WHITE = White BLAK = Black GRAY = Gray ROSE = Rose CAPP = Cappuccino SAGE = Sage BRNZ = Bronze BRSS = Brass SLVR = Silver XXXX² = On-Demand Color	Outer Shade Textures: LF = Layered Fine NL = Natural Lines VF = Vertical Fine XX² = Other Shade Texture
Notes	Notes	Notes 1. See page 3 for images of color options. 2. On-Demand colors available with possible extended lead times and additional costs. Consult factory. See page 3 for images of On-Demand color options.	Notes 1. See page 4 for texture details and options. 2. Consult factory to request other textures. Shop drawings may be required. Extended lead times, additional costs, and minimum order quantity may apply.

Continue here to make complete selections

Inner Shade Color	Inner Shade Texture	Canopy Shape and Color
Standard Inner Shade Colors: WHHR = High Reflective White ¹ BRSS = Brass BRNZ = Bronze XXXX² = On-Demand Color	Standard Inner Shade Textures: SR = Smooth layered fine texture BR = Baffle reflector, corrugated texture FL = Floral reflector, decorative texture XX³ = Other Inner Shade Texture	DW = Disk - White DB = Disk - Black DC = Disk canopy matches outer shade color (opaque color only) CW = Conical - White CB = Conical - Black CC = Conical canopy matches outer shade color (opaque color only)
Notes 1. High Reflective White (WHHR) should be selected for maximum light output. 2. On-Demand colors available with possible extended lead times and additional costs. Consult factory. See page 3 for images of on-demand color options.	Notes 1. See page 4 for texture details and options. 2. Consult factory to request other textures. Shop drawings may be required. Extended lead times, additional costs, and minimum order quantity may apply.	Notes 1. Standard length of cord - 10ft [3050 mm]. Max available length is 25ft [7.62 m]. Consult factory for lengths longer than 10ft. 2. Power cord is always silver.

Product Specifications

Construction

- PrentaLux 200s consist of an integral LED light engine and a proprietary additive manufacturing process for the polycarbonate shade and components.
- 200 series shades utilize a proprietary, impact resistant polycarbonate for maximum durability
- The polycarbonate used for PrentaLux fixtures is bio-circular and thermally, mechanically and optically optimized for professional/commercial installations. Designed, engineered, and printed in the United States.

Electrical

- Standard 0-10V driver (with dimming from 100% to 1%) integrated into the pendant head (120/277V/50-60Hz).

LED & Light Engine

- Available in 2700K, 3000K, 3500K, and 4000K CCT
- 90 CRI standard
- 8 Lumen packages ranging from nominal 1000, 1500, 2000, 3000, 4500, 6000, 7000+ lumens. (subject to specific CCT and Light Level).

Driver

- Standard offering is 0-10V with 1% dimming.

Optics

- Clear or frosted lens options available
- Polar plot and UGR data on page 5.

Environment

- Suited for 25° ambient. Dry location only.

Shielding

- Shade optic depth and design provides excellent physical cut off.
- 3D printing enabled personalization allows for easy adjustment of cut off angle (MOQ may apply)

Colors & Textures

- 9 standard outer shade colors available. 3 standard inner shade colors available.
- High Reflective White inner shade color should be selected for maximum light output.
- 3 inner shade textures offered.
- On-Demand colors and textures available with possible extended lead times and additional costs. Please consult factory.

Mounting

- Mounting options include UL certified cord and option of 3D printed disk shape or conical shape, mounting hardware.

Lengths

- Fixture comes with 10ft cord. Lengths up to 25 ft possible. (Consult factory as longer lead times apply).

Weight

- All products are light weight and much easier to install than traditional pendants.
- 205 fixture weighs approximately 9.2lbs

Warranty

- Standard five-year limited warranty on all parts.

Compliance

- Components are UL recognized and luminaires are cULus listed for 25° C ambient environments. Dry Location Listed
- Filament material is UL certified.
- BAA compliant
- RoHS compliant
- Declare Compliant, LBC Red List Approved, ISCC Certified
- Not to be installed in food prep areas and hazardous environments which may expose the product to pollutants such as oil, grease, or VOCs.
- IK02 impact rated. Not for installations in locations such as gymnasiums, arenas, sports complexes, multi-purpose rooms, and any other locations where the fixture potentially will be subject to impacts from external sources.

Sustainability Specifications

- PrentaLux 3D printed parts are produced with at least 75% mass balanced bio-circular materials.
- 61% of the 205 lighting fixture, is made of 3D printed material.
- ISCC certified. Certification applies only to 3D printed material.
- Declare compliant
- LBC Red List Approved

Standard Opaque Outer Shade Colors

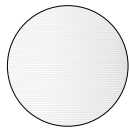

WHITE - White



BLAK - Black



GRAY - Gray

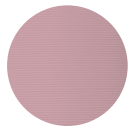

ROSE - Rose



CAPP - Cappuccino



SAGE - Sage



BRNZ - Bronze



BRSS - Brass



SLVR - Silver

Standard Inner Shade Colors

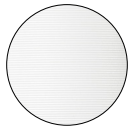

WHHR - White
High Performance
Reflective White



BRSS - Brass



BRNZ - Bronze

On-Demand Colors

These additional color offerings for inner and outer shade may have extended lead times and/or additional costs. Please consult factory.



ENGR - Enamel Green



MEGR - Metallic Green



MCHA - Matcha

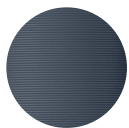

STBL - Steel Blue

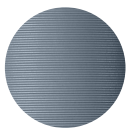

MEBL - Metallic Blue

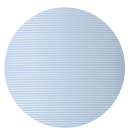

MYBL - Misty Blue



DKGY - Dark Gray



STBR - Stone Brown



MEPU - Metallic Purple



RGLD - Rose Gold



CITR - Citrona



CRWH - Cream White



BURG - Burgundy

Outer Shade Textures



LF - Layered Fine



VF - Vertical Fine



NL - Natural Lines

Inner Shade Textures



SR - Smooth

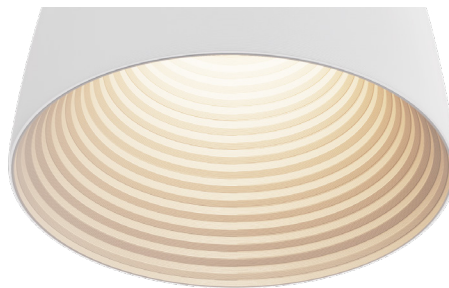

BR - Baffle



FL - Floral

Mounting - Canopy Options

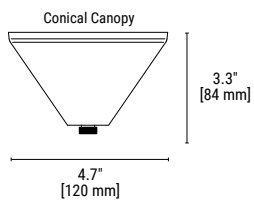
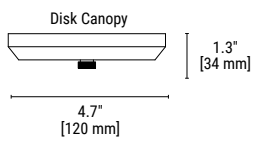

Canopy Colors

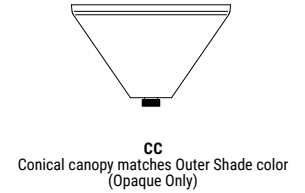
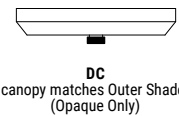

Photometric Data

PRENTALUX - 205 - @ 3500K / 90 CRI WITH CLEAR LENS									
	Light Level 1	Light Level 8							
Filename	205-90-35K-LL1-UNV-STD-X-X-WHHR-SR-X.ies	205-90-35K-LL8-UNV-STD-X-X-WHHR-SR-X.ies	<p>Color Vector Graphic TM-30</p> <table border="1"> <tr> <td>R_i</td> <td>90.6</td> </tr> <tr> <td>R_g</td> <td>101.2</td> </tr> <tr> <td>R9</td> <td>60.2</td> </tr> </table>	R _i	90.6	R _g	101.2	R9	60.2
R _i	90.6								
R _g	101.2								
R9	60.2								
Test No.	P600606	P600627							
Lumcat	205-90-35K-LL1-UNV-STD-X-X-WHHR-SR-X	205-90-35K-LL8-UNV-STD-X-X-WHHR-SR-X							
Lumens	1128.9 Lm	6807.4 Lm							
Input Watts	9.5 W	72.2 W							
Efficacy	118.8 Lm/W	94.3 Lm/W							
CCT	3500K	3500K							
Spacing Criteria (0/90/45)	1.01 / 1.01 / 1.17	1.01 / 1.01 / 1.17							

Lumen/Wattage/LPW Table

LUMEN Table per CRI, CCT, and Light Level			205 ¹ (inner diam nominal 16", inner textures)			WATTS	EFFICACY (Lm/W)
			Smooth	Floral	Baffle		
CRI	CCT	LL	SR	FL	BR		
90	2700	LL1	1031	1027	1036	10	96
		LL2	1468	1463	1475	13	105
		LL3	2000	1992	2009	18	103
		LL4	2609	2599	2621	24	101
		LL5	3646	3633	3663	34	99
		LL6	4152	4137	4172	40	96
		LL7	5364	5344	5389	56	89
		LL8	6215	6193	6245	73	79
	3000	LL1	1093	1089	1098	10	101
		LL2	1556	1551	1564	13	111
		LL3	2120	2112	2130	18	109
		LL4	2766	2756	2779	24	107
		LL5	3865	3851	3883	34	105
		LL6	4402	4386	4422	40	102
		LL7	5686	5666	5713	56	94
		LL8	6589	6565	6620	73	84
	3500	LL1	1129	1125	1134	10	105
		LL2	1608	1602	1616	13	115
		LL3	2190	2182	2201	18	113
		LL4	2857	2847	2871	24	110
		LL5	3993	3979	4012	34	109
		LL6	4547	4531	4569	40	105
		LL7	5874	5853	5902	56	97
		LL8	6807	6783	6840	73	86
4000	LL1	1171	1167	1176	10	109	
	LL2	1668	1662	1676	13	119	
	LL3	2271	2263	2282	18	117	
	LL4	2963	2953	2978	24	114	
	LL5	4141	4126	4161	34	113	
	LL6	4716	4699	4739	40	109	
	LL7	6093	6071	6122	56	101	
	LL8	7060	7035	7094	73	90	

UGR Data Table

Light Level @ 3500K [205] Smooth Reflector		CCT	UGR [CIE 190:2010] (4H, 8H; Reflectance: 70% Ceiling, 50% Wall, 20% Ref. Plane)	MAX LUMINANCE [45-90 DEG FROM NADIR] (2) (CD/M ²)
			90 CRI	90 CRI
			205	205
LL1	1129	3500K	15.7	1608
LL2	1608	3500K	16.9	2289
LL3	2190	3500K	18.0	3119
LL4	2857	3500K	18.9	4069
LL5	3993	3500K	20.1	5687
LL6	4547	3500K	20.5	6476
LL7	5874	3500K	21.4	8366
LL8	6807	3500K	21.9	9694

Lumen Maintenance

Ambient Temperature
25°C
Lumen Maintenance: TM-21-11 (60,000 Hours)
>80%
Theoretical L70 (Hrs)
>=66,000

NOTES

- Frosted lens will decrease delivered lumen output. Contact factory for details