

Project		Catalog #		Type	
Prepared by		Notes		Date	

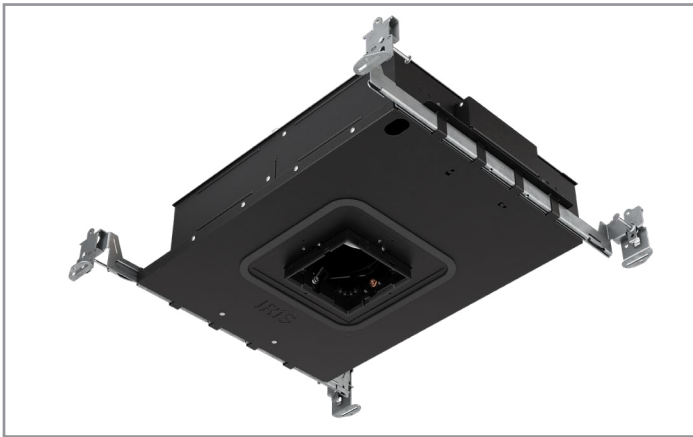

# IRiS

## P3SQAS

3" Shallow Square Adjustable / Accent / Slope Ceiling Downlight

### Typical Applications

Residential • Hospitality • Retail • Office • Education • Healthcare

### Interactive Menu

- Order Information [page 2](#)
- Product Specifications [page 4](#)
- Energy & Performance Data [page 6](#)
- Photometric Data [page 7](#)
- Connected Systems [page 9](#)
- Product Warranty



### Top Product Features

- Shallow housing for 2X4 construction
- Magnetically guided snap in driver for ease of maintenance
- Locking 365° rotation and 35° tilt holds any aiming position
- Interchangeable optics: 8°, 12°, 10°–70° in 5° increments, and asymmetric patterns
- Available in 250 to 1300 lumens
- Offered in 90, 97 and 98 CRI
- Media holder accepts two lens media
- 2400K, 2700K, 3000K, 3500K, 4000K, 5000K; 1 SDCM
- D2W™ Dim-to-Warm option from 3000K to 1850K
- W2N™ Tunable White CCT range 2700K to 6500K or 2000K to 5000K
- BioUp™ Melanopic Lighting in Tunable White (2700K to 5000K) or Static White
- Options to meet Buy American and other domestic preference requirements

### Dimensional and Mounting Details

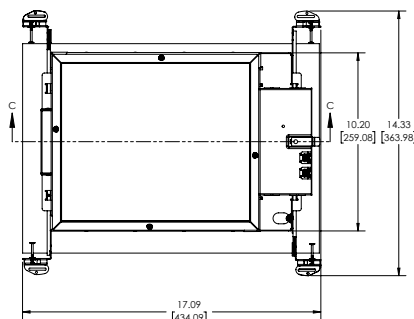

FLANGED TRIM

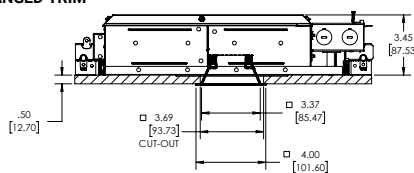

KNIFE EDGE TRIM

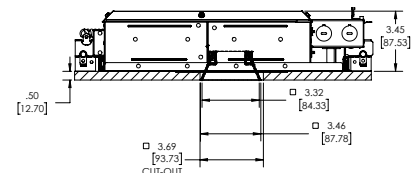

Order Information

SAMPLE ORDER NUMBER: P3SQAS09R159030DTR E3SQCA1MW

Domestic Preferences (6)	Housing (Extension collars available for ceiling thicknesses >.75")	Lumens (Nominal Lumens will vary depending on selected color, CRI, driver and trim finish)	Optics (1)(2)	CRI / CCT
<p>[blank]=Standard  <b>BAA</b> = Buy American Act  <b>TAA</b> = Trade Agreements Act</p>	<p><b>P3SQA</b> = 3" Square 35° Adjustable Accent New Construction Recessed Downlight  <b>P3SQACP</b> = 3" Square 35° Adjustable Accent New Construction Recessed Downlight, CCEA Chicago Plenum and Spray Foam Rated (Closed cell spray foam insulation with a maximum R-value of 6.8R/in. This allows use in ceiling cavities insulated up to R60.)</p>	<p><b>90/97/98 CRI IC Rated</b>  <b>02</b> = 250 lm  <b>05</b> = 500 lm  <b>09</b> = 900 lm  <b>13</b> = 1300 lm</p> <p><b>D2W™ Dim-to-Warm (1)(2) IC Rated</b>  <b>02</b> = 250 lm  <b>05</b> = 500 lm  <b>09</b> = 900 lm</p> <p><b>W2N™ Tunable White (1)(2) IC Rated</b>  <b>05</b> = 500 lm  <b>09</b> = 900 lm  <b>13</b> = 1300 lm</p> <p><b>BioUp™ Melanopic Lighting (1)(2) IC Rated</b>  <b>05</b> = 500 lm  <b>09</b> = 900 lm</p>	<p>[blank] = Order optic separately (Available for ≥15°)  <b>R08</b> = 8° (Offered in 250 lm; Requires DE010 or D5LT driver) (3)  <b>R10</b> = 10° (Offered for 250–900 lm) (3)  <b>R12</b> = 12° (Offered ≤1300 lm) (3)  <b>R15</b> = 15°  <b>R20</b> = 20°  <b>R25</b> = 25°  <b>R30</b> = 30°  <b>R35</b> = 35°  <b>R40</b> = 40°  <b>R45</b> = 45°  <b>R50</b> = 50°  <b>R55</b> = 55°  <b>R60</b> = 60°  <b>R65</b> = 65°  <b>R70</b> = 70° (Required when using wall wash trims)</p> <p>Asymmetric Elliptical  <b>2R2040</b> = 20° x 40°  <b>2R2050</b> = 20° x 50°  <b>2R2060</b> = 20° x 60°</p>	<p><b>90 CRI (min)</b>  <b>9024</b> = 2400K  <b>9027</b> = 2700K  <b>9030</b> = 3000K  <b>9035</b> = 3500K  <b>9040</b> = 4000K  <b>9050</b> = 5000K</p> <p><b>97 CRI (min)</b>  <b>9727</b> = 2700K  <b>9730</b> = 3000K  <b>9735</b> = 3500K  <b>9740</b> = 4000K</p> <p><b>98 CRI</b>  (250–1300 lm use 2x6 housing, 1700–2000 lm use 2x8 housing)  <b>9824</b> = 2400K  <b>9827</b> = 2700K  <b>9830</b> = 3000K  <b>9835</b> = 3500K  <b>9840</b> = 4000K</p> <p><b>D2W™ Dim-to-Warm</b>  (90 CRI min, IC rated ≤900 lumens; offered with ≥15° optics)  <b>9030D2W</b> = Dim-to-Warm, 3000K–1850K</p> <p><b>W2N™ Tunable White</b>  (Specify with DE010, D5LT or LD2 remote driver; offered with ≥15° optics)  <b>W2N902050</b> = Tunable White, 2000K–5000K  <b>W2N902765</b> = Tunable White, 2700K–6500K</p> <p><b>BioUp™</b>  (Specify with DE010, D5LT or LD2 remote driver; offered with ≥15° optics)  <b>B2750</b> = BioUp™ Boosted cyan tunable white, 2700K–5000K  <b>B35</b> = Static BioUp™, 3500K (DE010 driver only)  <b>B40</b> = Static BioUp™, 4000K (DE010 driver only)  <b>B50</b> = Static BioUp™, 5000K (DE010 driver only)</p>

Driver Voltage / Control	Driver Options	Options (6)
<p><b>Phase Cut Dimming</b>  <b>DTR</b> = 120V phase cut 1% dimming</p> <p><b>0-10V Dimming</b>  <b>D010</b> = UNV 120-277V, 0-10V 1% dimming  <b>3D010</b> = 347V 0-10V 1% dimming (900 lm and above)  <b>DE010</b> = UNV 120-277V, 0-10V linear, 0.1% dimming (≥250lm for D2W and ≥500 lm for other CRI/CCT)</p> <p><b>DALI &amp; DMX</b>  <b>D5LT</b> = UNV 120-277V DALI DT6 logarithmic 0.1% dimming (≥250lm for D2W and ≥500 lm for other CRI/CCT)  <b>DMX</b> = UNV 120-277V DMX/RDM logarithmic 0.1% dimming (≥250lm for D2W and ≥500 lm for other CRI/CCT), remote driver only (5)  <b>DMXC5</b> = UNV 120-277V DMX/RDM logarithmic 0.1% dimming with RJ45 connection (≥250lm for D2W and ≥500 lm for other CRI/CCT), remote driver only (5)</p> <p><b>Lutron® EcoSystem™ &amp; DALI</b>  <b>DLE</b> = UNV 120-277V Lutron® EcoSystem™ 1% dimming (≥900 lm), remote driver only  <b>LD2</b> = Lutron® DALI UNV 120-277V for Tunable White (900 lm only), remote driver only</p>	<p>[blank] = Integral driver (Offered with DTR, D010, 3D010, DE010 and D5LT driver) 90/97/98 CRI and D2W  <b>R</b> = Remote driver (Order remote driver separately.)</p>	<p><b>Emergency Battery Backup</b>  <b>EMB0D6ST</b> = Bodine® 7W Emergency Module with Remote Test Switch (≥500 lm)  <b>EM7</b> = 7W Integral Emergency Backup Battery with Remote Test Switch (≥900 lm)  <b>EM14</b> = 14W Integral Emergency Backup Battery with Remote Test Switch (≥1700 lm)  <b>ETRD</b> = Emergency Transfer Device</p> <p><b>WaveLinX</b>  (Factory-installed)  <b>WPST</b> = WaveLinX PRO Sensor kit  <b>WLST</b> = WaveLinX LITE Sensor kit  <b>WPN</b> = WaveLinX PRO Wireless Node without Sensor (Specify with DE010 or D010 driver)  <b>WLN</b> = WaveLinX LITE Wireless Node without Sensor (Specify with DE010 or D010 driver)</p> <p><b>Lutron® Athena™</b>  <b>AWN</b> = Lutron® Athena™ Wireless Node (Specify with D010, DE010, or LD2)</p>

Square Die cast Aluminum and Non-conductive Trims (Micro Flange or Knife edge rimless plaster / millwork)	Lens (Required for outdoor use)	Flange Style and finish	Reflector Finish
<p><b>Downlight</b>  <b>E3SQCD</b> = 3" Full cone  <b>E3SQCB</b> = 3" Bevel (Not offered with lens)  <b>E3SQCBUS</b> = 3" Ultra-shallow Bevel (For use with integral emergency) and lens</p> <p><b>Angle Cut Cone &amp; Adjustable</b>  <b>E3SQCA45</b> = 3" 45° Angle cut cone  <b>E3SQCA30</b> = 3" 30° Angle cut cone  <b>E3SQPHS</b> = 3" Pinhole (For downlight or tilted; Use with Flange Style 1 or 4)  <b>E3SQCSA</b> = 3" Super adjustable (Not available with lens; use with Flange Style 1 or 4)</p>	<p><b>Wall Wash</b>  (Specify with 70° optic)  <b>E3SQCLSWW</b> = 3" Lensed single wall wash  <b>E3SQCLDWW</b> = 3" Lensed double wall wash</p> <p><b>Non-conductive</b>  (Use with Self-flanged Style 1; Select Matte Black or Matte White finish; Lens selection required)  <b>E3SQPB</b> = 3" Bevel, Dead front  <b>E3SQPA45</b> = 3" 45° Angle cut cone, Dead front</p>	<p>[blank] = Open, hyperbolic, lensed wall wash, or super adjustable</p> <p><b>Lenses</b>  (Required for outdoor use)  <b>L</b> = Textured clear lens  <b>LP</b> = Prismatic lens  <b>LD</b> = Diffuse lens</p> <p>1 = Self-flanged (Flange matches reflector finish)  2 = Self-flanged (Flange is painted Matte White)  4 = Knife edge rimless for millwork and plaster (Requires accessories: adapters, and collars depending on ceiling material and thickness; Rimless plaster lathing ring required for plaster ceilings)  5 = Self-flanged (Flange is painted Matte Black)</p>	<p><b>MW</b> = Matte White  <b>MB</b> = Matte Black  <b>MMS</b> = Matte Metallic Silver  <b>BZ</b> = Bronze</p>

Continued on next page.

Order Information

Media and Optic Accessories					
Optics			Media Filters		Lens Options
<b>2R15SP</b> = 15° Beam <b>2R20</b> = 20° Beam <b>2R25NFL</b> = 25° Beam <b>2R30</b> = 30° Beam <b>2R35</b> = 35° Beam <b>2R40FL</b> = 40° Beam <b>2R45</b> = 45° Beam	<b>2R50</b> = 50° Beam <b>2R55WFL</b> = 55° Beam <b>2R60</b> = 60° Beam <b>2R65</b> = 65° Beam <b>2R70</b> = 70° Beam	Asymmetric Elliptical <b>2R2040</b> = 20° x 40° <b>2R2050</b> = 20° x 50° <b>2R2060</b> = 20° x 60°	<b>L112</b> = Red gel filter <b>L114</b> = Ultraviolet dichroic filter <b>L120</b> = Red dichroic filter <b>L121</b> = Amber dichroic filter <b>L122</b> = Yellow dichroic filter	<b>L123</b> = Green dichroic filter <b>L124</b> = Daylight blue dichroic filter <b>L125</b> = Blue dichroic filter <b>L127</b> = Cosmetic (2700K) dichroic filter <b>L131</b> = Amber gel filter	<b>L110N</b> = Diffuse Sandblasted Lens <b>L111</b> = Soft Focus Lens <b>L113</b> = Prismatic Spread Lens <b>L115</b> = Linear Spread Lens <b>L100MB</b> = Hex cell louver

Accessories			
<b>Knife Edge Rimless Trim Installations</b> (Required for use with Knife Edge rimless plaster trims; Use with collar adapter below based on ceiling thickness) <b>PRSQ3</b> = Rimless plaster lathing ring	<b>Millwork &amp; Plaster Collar Adapter</b> (Required for Knife Edge rimless millwork or plaster trims. Includes installation tool for setting precise trim depth in the ceiling. Above ceiling access required for splice inspection in > 1.5 inch ceiling thickness.) <b>CASQ3A</b> = Collar adapter for 0.5"-0.75" ceilings <b>CASQ3B</b> = Collar adapter for 0.875"-1.125" ceilings <b>CASQ3C</b> = Collar adapter for 1.25" ceilings <b>CASQ3D</b> = Collar adapter for 1.5"-1.625" ceilings <b>CASQ3E</b> = Collar adapter for 1.75"-2.00" ceilings <b>CASQ3F</b> = Collar adapter for 2.00"- 2.25" ceilings <b>CASQ3G</b> = Collar adapter for 2.25"-2.50" ceilings	<b>Extension Collars For Self-flanged Trims</b> (For ceilings thicker than .75". Above ceiling access required for splice inspection in > 1.5 inch ceiling thickness.) <b>PCESQ3A</b> = Plaster Collar Extender for 0.875"-1.125" ceilings <b>PCESQ3B</b> = Plaster Collar Extender for 1.25" ceilings <b>PCESQ3C</b> = Plaster Collar Extender for 1.5"-1.625" ceilings <b>PCESQ3D</b> = Plaster Collar Extender for 1.75"-2.00" ceilings <b>PCESQ3E</b> = Plaster Collar Extender for 2.00"-2.25" ceilings <b>PCESQ3F</b> = Plaster Collar Extender for 2.25"-2.50" ceilings	<b>WaveLinX Sensor Kits</b> <b>WPST</b> = Field-installed WaveLinX PRO Sensor Kit <b>WLST</b> = Field-installed WaveLinX LITE Sensor Kit

Required if remote driver (R) is specified

Remote driver				
Domestic Preferences <sup>(6)</sup>	Flexible Metal Clad Conduit with Wires	Lumens	Color Control	Driver
<b>[blank]</b> =Standard <b>BAA</b> = Buy American Act <b>TAA</b> = Trade Agreements Act	<b>RN100</b> = Remote 100ft <b>RN50</b> = Remote 50ft <b>RN25</b> = Remote 25ft <b>RN15</b> = Remote 15ft <b>RN5</b> = Remote 5ft <b>RN2</b> = Remote 2ft	<b>IC Rated</b> <b>02</b> = 250 lm <b>05</b> = 500 lm <b>09</b> = 900 lm <b>13</b> = 1300 lm	<b>[blank]</b> = 90, 97 and 98 CRI <b>D2W™ Dim-to-Warm</b> <sup>(1)(2)</sup> (90 CRI min, ≤900 lm) <b>9030D2W</b> = Dim-to-Warm, 3000K-1850K <b>W2N™ Tunable White</b> <sup>(1)(2)</sup> (Specify with D5LT or DE010 driver) <b>W2N902050</b> = Tunable white, 2000K-5000K CCT (500-1300 lm) <b>W2N902765</b> = Tunable white, 2700K-6500K CCT (500-1300 lm) <b>BioUp™ Melanopic Lighting</b> <sup>(1)(2)</sup> <b>B2750</b> = BioUp™ Boosted cyan tunable white 2700K-5000K (Specify with D5LT or DE010 driver; 500-900 lm) <b>B35</b> = Static BioUp™ 3500K (DE010 remote driver only; 500-900 lm) <b>B40</b> = Static BioUp™ 4000K (DE010 remote driver only; 500-900 lm) <b>B50</b> = Static BioUp™ 5000K (DE010 remote driver only; 500-900 lm)	<b>Phase Cut Dimming</b> <b>DTR</b> = 120V phase cut 1% dimming <b>0-10V Dimming</b> <b>D010</b> = UNV 120-277V, 0-10V 1% dimming <b>3D010</b> = 347V 0-10V 1% dimming (900-1300 lm) <b>DE010</b> = UNV 120-277V, 0-10V linear, 0.1% dimming (500-1300 lm) <b>DALI &amp; DMX</b> <b>D5LT</b> = UNV 120-277V DALI DT6 logarithmic 0.1% dimming (500-1300 lm) <b>DMX</b> = UNV 120-277V DMX/RDM logarithmic 0.1% dimming (500-1300 lm) <sup>(5)</sup> <b>DMXC5</b> = UNV 120-277V DMX/RDM logarithmic 0.1% dimming with RJ45 connection (500-1300 lm) <sup>(5)</sup> <b>Lutron® EcoSystem™ &amp; DALI</b> <b>DLE</b> = UNV 120-277V Lutron® EcoSystem™ 1% dimming (≥900 lm; limited to 25ft.) <b>LD2</b> = Lutron® DALI UNV 120-277V for Tunable White (900 lm only)

Options
<b>Emergency Battery Backup</b> <b>EMB0D6ST</b> = Bodine® 7W Emergency Module with Remote Test Switch (≥500 lm) <b>EM7</b> = 7W Integral Emergency Backup Battery with Remote Test Switch (≥900 lm) <b>ETRD</b> = Emergency Transfer Device <b>WaveLinX</b> (Factory-installed; Specify with DE010 or D010 driver) <b>WPN</b> = WaveLinX PRO Wireless Node without Sensor <b>WLN</b> = WaveLinX LITE Wireless Node without Sensor <b>Lutron® Athena™</b> (Specify with D010, DE010, or LD2 driver) <b>AWN</b> = Lutron® Athena™ Wireless Node

Notes:

- Optic accommodates 2 media with 90, 97, and 98 CRI and 1 media with D2W™, W2N™, BioUp™.
- D2W™, W2N™ and BioUp™ are offered with ≥15° optics with up to 1300 lm.
- Optic must be specified with the housing for ≤12" with 90/97/98 CRI along with D2W™, W2N™, and BioUp™.
- DMX fixtures default to full ON upon loss of DMX signal. (DMX and DMXC5 require above ceiling access and do not include magnetic snap-in driver.)
- DMX fixtures default to full ON upon loss of DMX signal. (DMX and DMXC5 require above ceiling access and do not include magnetic snap-in driver.)
- Battery pack and node options require ceiling access, not compatible with 347V, Chicago plenum, or IC rated (insulated ceilings)

## Product Specifications

### Housing

- Shallow Die formed 18-gauge CRS housing is painted matte black for a visibly dark interior
- Collar rotates +/- 7.5° providing precise alignment
- Housing is top accessible
- Die cast aluminum collar accommodates ceilings up to 3/4" thick
- Extension collars offered to accommodate up to 2-½"
- Ships with an overspray protector already installed to safeguard the housing during construction.
- Accessory plaster lathing ring attaches to collar providing a flush transition with the ceiling
- Chicago Plenum (CP) IC housings are rated for closed cell spray foam insulation with a maximum R-value of 6.8R/in. This allows use in ceiling cavities insulated up to R60.

### Thermal Management / Heat sink

- High-performance extruded and diecast aluminum heat sink efficiently dissipates heat from the LED array, ensuring optimal thermal management and long life.
- Heat sink and LED assembly are designed for convenient servicing and maintenance from below the ceiling.

### Bar Hangers

- Adjusts from 10-1/2" to 24" wide with captive nail that penetrate standard and engineered lumber
- Mounting flange levels platform with ceiling
- Integral clip attaches directly to t-bar

### Junction Box

- Listed for eight #12 AWG 90° C splice conductors, four in, four out plus ground for phase dimming driver
- Four 1/2" conduit pry-outs
- Access to junction box through panel in side of housing
- Lever connectors for simple push in wiring

### Adjustment Mechanism

- Provides 365° rotation and 35° tilt capability for versatile aiming options and locks in position with #2 Phillips screwdriver
- Translating center beam optics provides maximum light output without flashback
- Integrated aiming scale allows for uniform and repeatable adjustments across multiple fixtures

### LED Array

- Proximity phosphors over chip on board • Proximity phosphors over chip on board LEDs provide a uniform source with high efficiency and no pixilation
- Available in 2400K, 2700K, 3000K, 3500K, 4000K, and 5000K CCTs, 90 CRI min, R9 >50.
- 90/97 CRI color accuracy within 1 SDCM (for 12° and above distributions). L78 55,000 hours.
- Optional full spectrum color at 2400, 2700, 3000, 3500 and 4000 K CCT, 95 CRI minimum with R1-R15 values ranging from 92 to 100, excellent TM-30 metrics; Rf ranging from 96-98 and Rg from 99-100. L70 55,000 hours
- D2W™ – dim-to-warm shifts CCT from 3000K to 1850K as fixture dims mimicking halogen sources.
- W2N - Tunable white CCT range 2700K to 6500K or 2000K to 5000K, 90 CRI. Standard
- BioUp - Tunable white CCT range 2700K to 5000K Provides the biological effectiveness of natural sunlight, with color temperatures that are more comfortable for indoor environments

### Optic

- Polarized turn-and-lock optic enables precise alignment to the light source, facilitating quick aiming and focusing adjustments in the field.
- Designed to deliver uniform beam patterns with distribution options ranging from 8°, 12°, 10° to 70° in 5° increments for versatile lighting applications.
- Asymmetric beam options available in specialized distribution patterns of 20x40, 20x50, and 20x60, offering tailored light coverage for specific requirements.
- Integrated media holder accommodates one or two 2" diameter media components, including 3.0mm thick color filters, lenses, or louvers.

### Reflector

- Trim is effortlessly secured using 16 neodymium magnets for reliable installation and easy adjustments.
- Field-changeable open and lensed reflectors are offered for downlight, wall wash, or pinhole aperture configurations to suit various lighting needs.
- Lens versions are wet location listed, making them suitable for use in showers, and steam room applications. Lens options include prismatic, diffuse, and lightly textured translucent clear finishes.
- Super Adjustable provides adjustable tilt between 15° and 75°, ideal for highlighting features in spaces with sloped ceilings.
- Wall Wash Reflector Options: Lensed wall wash reflectors are available in single and double wall wash designs, delivering uniform vertical illumination with minimal visible source brightness.
- Plaster lathing ring accessory provides a flush transition and snaps to the plaster collar
- Plaster and millwork collar adapter accessory features an integrated depth guide designed to ensure accurate installation and a seamless, flush transition with the ceiling.

### Driver - Remote or Integral

- Magnetically guided snap in driver for ease of maintenance with D010, DTR, DE010 3D010 and DLE drivers
- Standard UNV 120-277V or 347V constant current driver provides noise free operation
- 120V, flicker-free dimming from 100% to <1% with phase cut control
- Continuous, flicker-free dimming from 100% to 1% with 0-10V analog control
- Optional DALI, DMX and Lutron control

### WaveLinX Connected Lighting System

Two WaveLinX connected solutions to choose from. Refer to WaveLinX system specifications and application guides for details.

#### WaveLinX PRO Tilemount Sensor Kit

- Offers daylight dimming, PIR motion sensing, scene and zone configuration, and automatic commissioning; and optional RLTS - Real Time Location Services available.

#### WaveLinX PRO Wireless Node

- Provides luminaire-level control with scene and zone configuration without an integrated sensor; Connects wirelessly with daylight dimming sensor and PIR motion sensor if desired. Use with 0-10V drivers only. Note: Not compatible with 347V or Chicago plenum.

#### WaveLinX LITE Tilemount Sensor Kit

- Offers daylight dimming and PIR motion sensing, scene and grouping configuration.

#### WaveLinX LITE Wireless Node

- Provides luminaire level control with scene and zone configuration without an integrated sensor; Connects wirelessly with daylight dimming sensor and PIR motion sensor if desired. Use with 0-10V driver only. **Note:** Not compatible with 347V or Chicago plenum.

### WaveLinX Tilemount Sensor Kits Application

- The WPST and WLST tilemount sensor kits include a control module mounted on the luminaire junction box via 1/2" knock-out, and a tilemount sensor on 54-inch whip; for ceiling installation by direct-mount spring clips or via mounting bracket in octagon ceiling boxes.
- The WPST and WLST tilemount sensor kits may be ordered as factory installed on the luminaire, or ordered separately as a field installed accessory kit.
- **Note: WaveLinX PRO devices are only compatible with the WaveLinX PRO system.**
- **Note: WaveLinX LITE devices are only compatible with the WaveLinX LITE system.**

### Compliance

- cULus Certified to UL 1598 / C22.2 No. 250 suitable for wet locations with lensed trims (required for outdoor use); damp location with open trims
- Wet location and steam room (up to 40°C / 104°F), covered ceilings only, below the ceiling only with lensed trims
- cULus listed for 25°C ambient environments
- Insulated ceiling (IC) rated
- Chicago Plenum (CP) IC housings are rated for closed cell spray foam insulation with a maximum R-value of 6.8R/in. This allows use in ceiling cavities insulated up to R60. (Refer to ordering information table)
- Airtight per ASTM-E283
- FCC CFR Title 47 Part 15 Class B at 120VAC and Class A at 277VAC
- Declare compliant, LBC Red List approved
- RoHS compliant
- Photometric testing in accordance with IES LM-79-08
- Lumen maintenance projections in accordance with IES LM-80-08 and TM-21-11
- Can be used for State of California Title 24 high efficacy LED compliance under JA8, reference Modernized Appliance Efficiency Database System (MAEDBS) for 2019 JA8 High Efficacy Lighting

### Warranty

- Five year limited warranty, consult website for details. [www.cooperlighting.com/legal](http://www.cooperlighting.com/legal)

Dimensional and Mounting Details

ROUND SHALLOW HEIGHT HOUSING

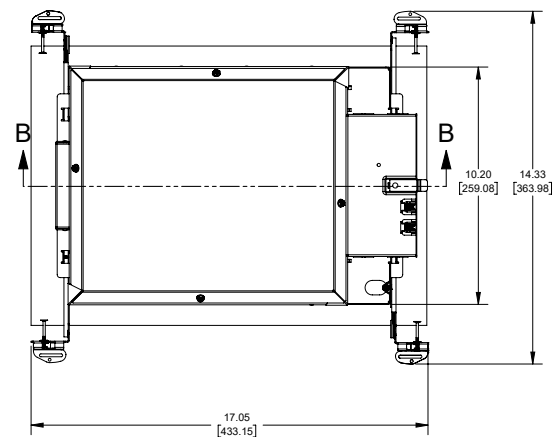

ROUND SHALLOW HEIGHT EMERGENCY HOUSING

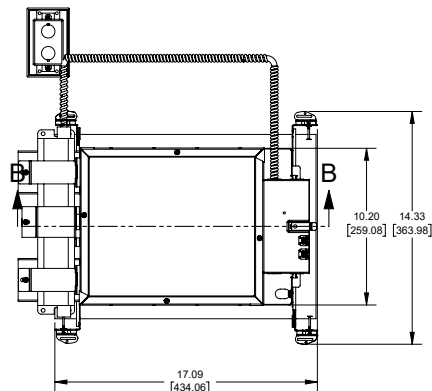

FLANGED TRIM

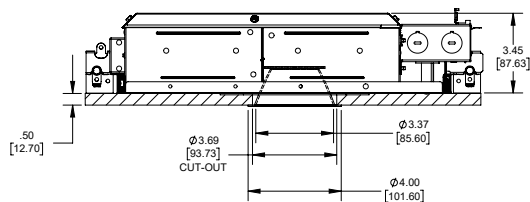

KNIFE EDGE TRIM

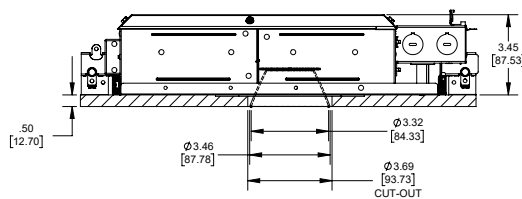

Trim Finishes

Square Painted Finishes



Matte Black (MB)



Matte White (MW)



Bronze (BZ)



Matte Metallic Silver (MMS)

Trim Type

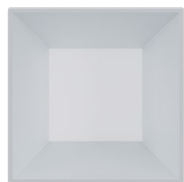

Knife Edge for Millwork and Plaster

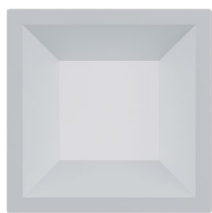

Standard Micro Flange

## Energy and Performance Data

### DTR DRIVER ENERGY DATA

	250 lumen	500 lumen	900 lumen	1300 lumen
Input Power (W)	4.2	8.7	13.5	16.5
Input Current (A)	0.04	0.07	0.11	0.14
PF	>0.9	>0.9	>0.9	>0.9
THDi (%)	18.01	7.8	7.64	8.32
Inrush Current (A)	1.6	1.7	4.9	0.5
Inrush Duration (µs)	33	30	33	32
Sound (dBA)	<22	<22	<22	<22

### D010 DRIVER ENERGY DATA

	250 lumen		500 lumen		900 lumen		1300 lumen	
	120V	277V	120V	277V	120V	277V	120V	277V
Input Power (W)	5.1	5.3	7.2	7.6	11.7	11.9	15.6	16.0
Input Current (A)	0.04	0.02	0.06	0.03	0.10	0.05	0.13	0.06
PF	>0.9	>0.9	>0.9	>0.9	>0.9	>0.9	>0.9	>0.9
THDi (%)	18.7	19.0	8.25	12.8	6.96	9.2	6.11	10.2
Inrush Current (A)	4.5	9.7	4.6	10.5	4.6	10.5	5.2	11.9
Inrush Duration (µs)	41	19	43	19	43	19	40	19
Sound (dBA)	<22	<22	<22	<22	<22	<22	<22	<22

Minimum starting temperature -30°C (-22°F)\*  
(Nominal input 120-277VAC & 100% of rated output power)

Sound Rating: Class A standards

**Notes:**

Emergency Battery packs are rated for a minimum starting temperature of 0°C.

### COLOR METRICS - TM-30-18 & CRI/CIE

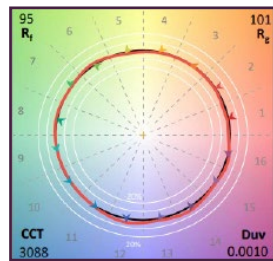
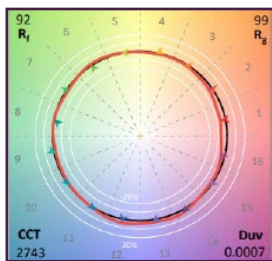
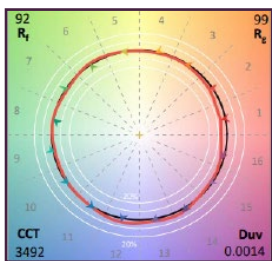
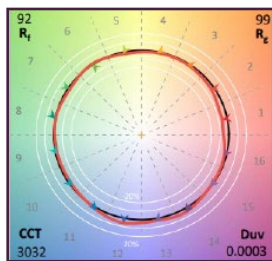
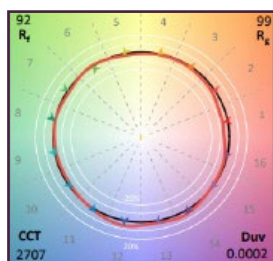

9027		
TM-30-18	R <sub>f</sub>	92
	R <sub>g</sub>	99
CRI/CIE	R <sub>a</sub>	92
	R <sub>9</sub>	50

9030		
TM-30-18	R <sub>f</sub>	92
	R <sub>g</sub>	99
CRI/CIE	R <sub>a</sub>	93
	R <sub>9</sub>	51

9035		
TM-30-18	R <sub>f</sub>	92
	R <sub>g</sub>	99
CRI/CIE	R <sub>a</sub>	93
	R <sub>9</sub>	58

9727		
TM-30-18	R <sub>f</sub>	92
	R <sub>g</sub>	99
CRI/CIE	R <sub>a</sub>	97
	R <sub>9</sub>	85

9730		
TM-30-18	R <sub>f</sub>	101
	R <sub>g</sub>	95
CRI/CIE	R <sub>a</sub>	97
	R <sub>9</sub>	83

## Photometric Data

E3SQCBUS1MW		250 lm	500 lm	900 lm	1300 lm
R08 8° Optic	CBCP	6471	#N/A	#N/A	#N/A
	Lumens	247	#N/A	#N/A	#N/A
	LPW	51.0	#N/A	#N/A	#N/A
	UGR*	0	0	0	0
R10 10° Optic	CBCP	6454	13265	19947	#N/A
	Lumens	295	567	767	#N/A
	LPW	78.5	71.3	61.4	#N/A
	UGR*	0	0	0	0
R12 12° Optic	CBCP	4607	9469	13950	18381
	Lumens	313	630	915	1142
	LPW	85.1	83.3	78.2	73.7
	UGR*	0	0	0	0
R15 15° Optic	CBCP	5580	11468	17245	22261
	Lumens	315	647	959	1257
	LPW	87.8	89.4	86.4	86.1
	UGR*	0	0	0	0
R20 20° Optic	CBCP	4311	8860	13322	17198
	Lumens	305	628	974	1219
	LPW	85.1	86.7	87.7	83.5
	UGR*	0	0	0	0
R25 25° Optic	CBCP	3356	6897	10372	13389
	Lumens	330	677	989	1314
	LPW	91.8	93.4	89.1	90.0
	UGR*	0	0	0	0
R30 30° Optic	CBCP	2277	4680	7038	9085
	Lumens	307	632	977	1228
	LPW	85.5	87.3	88.0	84.1
	UGR*	0	0	0	0
R35 35° Optic	CBCP	1845	3792	5702	7361
	Lumens	307	632	965	1227
	LPW	85.5	87.3	86.9	84.0
	UGR*	0	0	0	0
R40 40° Optic	CBCP	1617	3325	5000	6454
	Lumens	341	701	1071	1361
	LPW	95.1	96.8	96.5	93.2
	UGR*	0	0	0	0
R45 45° Optic	CBCP	1176	2416	3634	4691
	Lumens	330	679	1022	1319
	LPW	92.0	93.8	92.1	90.3
	UGR*	0	0	0.6	1.6

## Photometric Data

E3SQCBUS1MW		250 lm	500 lm	900 lm	1300 lm
R50 50° Optic	CBCP	1100	2262	3401	4391
	Lumens	343	706	1061	1370
	LPW	95.5	97.5	95.6	93.8
	UGR*	0	0	0.3	1.3
R55 55° Optic	CBCP	849	1743	2621	3384
	Lumens	321	658	990	1278
	LPW	89.3	90.9	89.2	87.6
	UGR*	0	0.4	1.7	2.7
R60 60° Optic	CBCP	712	1463	2199	2839
	Lumens	311	640	962	1242
	LPW	86.6	88.4	86.7	85.1
	UGR*	0.9	3.4	4.7	5.7
R65 65° Optic	CBCP	724	1489	2239	2890
	Lumens	293	602	904	1167
	LPW	81.5	83.1	81.4	80.0
	UGR*	2.1	4.6	5.9	6.9
R70 70° Optic	CBCP	526	1081	1626	2099
	Lumens	299	616	926	1196
	LPW	83.4	85.1	83.4	81.8
	UGR*	5.6	8.1	9.4	10.4

## MULTIPLIER

	2400K	2700K	3000K	3500K	4000K	5000K
90 CRI	0.86	0.91	0.97	1.00	1.05	1.06
97 CRI	0.83	0.86	#N/A	#N/A	#N/A	#N/A
98 CRI	#N/A	0.65	0.70	0.76	0.80	0.78

\* The values are the 4H/8H 70:50:20 UGR table values (industry standard value)

Connected Systems

WaveLinx LITE - WLST Tilemount Sensor

WaveLinx LITE devices only compatible with the WaveLinx LITE system.

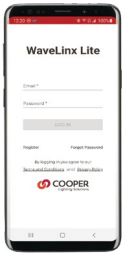

- Intuitive Android™ or Apple® iOS® app for basic system code compliant set up and configuration via Bluetooth
- Up to 28 unique areas per project site (WaveLinx LITE Bluetooth network)
- Up to 50 devices for an area, any one of 16 control zones, up to 6 occupancy sets, and custom lighting scenes
- Automatic occupancy or vacancy, sensor sensitivity, daylight dimming, etc. configurable through the app
- Refer to the WaveLinx system specifications for details



WaveLinx LITE WLST Tilemount Wiring Diagram

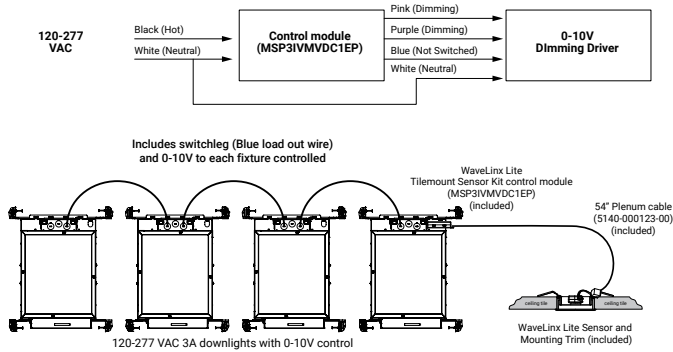

WaveLinx LITE Bluetooth Enabled System



WaveLinx PRO Wireless – WPST Tilemount Sensor

WaveLinx PRO devices only compatible with the WaveLinx PRO system.



- WaveLinx PRO Wireless functionality configures zones and customizes settings from one secure mobile app
- Automatic code commissioning that meets the strictest codes
- Fixtures and sensors integrate with Wireless Area Controller, Wall Stations, and Control Devices
- Stand-Alone Offices or Entire Building Network Installations



WaveLinx mobile app settings

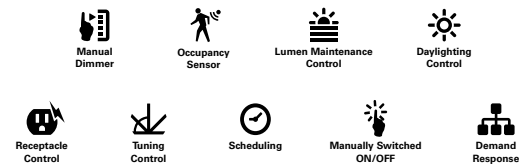

WaveLinx PRO WPST Tilemount Wiring Diagram

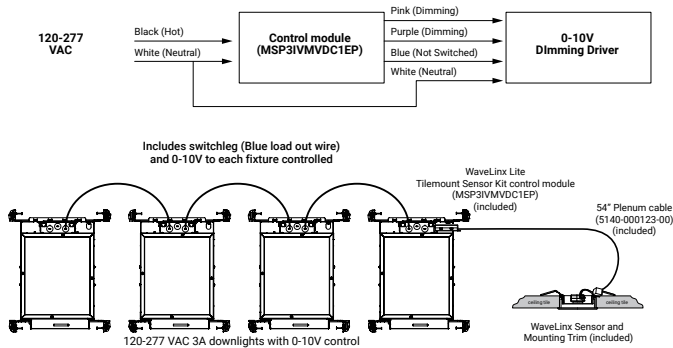

WaveLinx CORE Building Management Integration

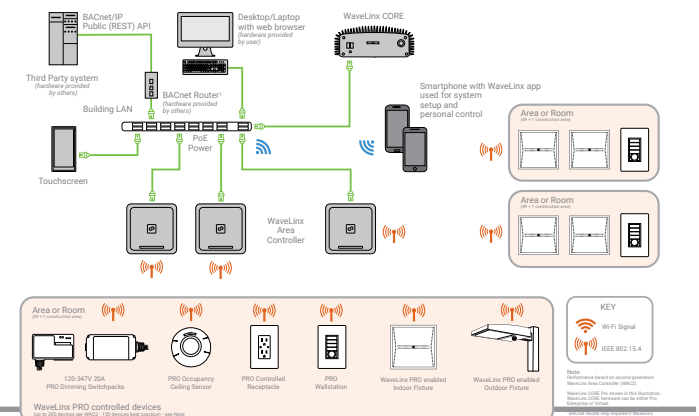

Connected Solutions



WaveLinX LITE Wireless Node - WLN

WaveLinX LITE devices only compatible with the WaveLinX LITE system.

- Intuitive Android™ or Apple® iOS® app for basic system code compliant set up and configuration via Bluetooth
- Up to 28 unique areas per project site (WaveLinX LITE Bluetooth network)
- Up to 50 devices for an area, any one of 16 control zones, up to 6 occupancy sets, and custom lighting scenes
- Refer to the WaveLinX system specifications for details
- Not available with BioUp or Tunable White

WaveLinX mobile app settings



WaveLinX LITE Wireless Node (WLN) Wiring Diagram

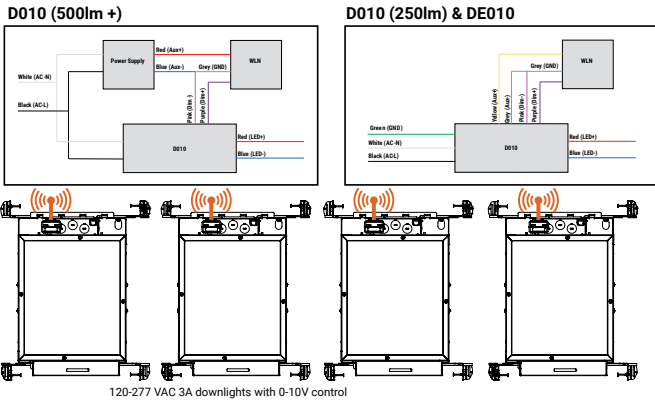

WaveLinX LITE Bluetooth Enabled System



WaveLinX PRO Wireless Node - WPN

WaveLinX PRO devices only compatible with the WaveLinX PRO system.

- WaveLinX Wireless functionality configures zones and customizes settings from one secure mobile app
- Automatic code commissioning that meets the strictest codes
- Fixtures and sensors integrate with WaveLinX Area Controller, Wall Stations, and Control Devices
- Stand-Alone Offices or Entire Building Network Installations

Downlights with wireless communication: Highly efficient LED fixtures

WaveLinX Area Controller: Provides centralized coordination of multiple area control options

Wireless Wall Station/Receptacle: Provides customized wireless control of each area

Mobile Applications: Provides personalized, local control from a tablet or smartphone

WaveLinX mobile app settings

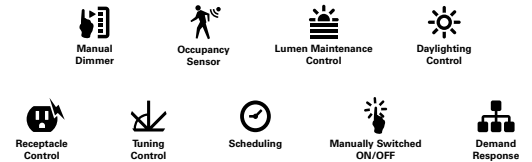

WaveLinX PRO Wireless Node (WPN) Wiring Diagram

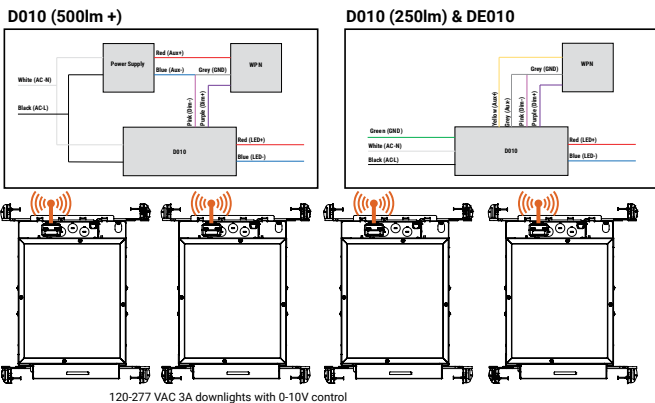

WaveLinX CORE Building Management Integration

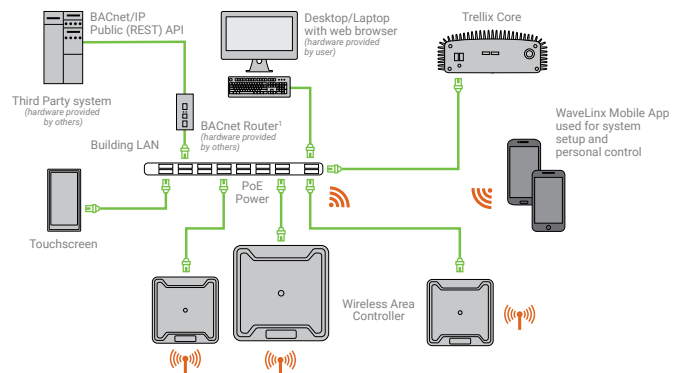

# Proven Research. Industry Recognized.

## BioUp Melanopic Lighting



See better



Feel better



Function better



See [BioUp brochure](#) for more details

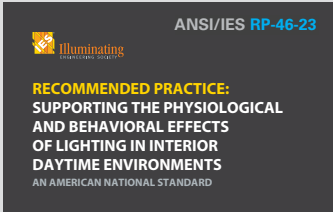

**ANSI/IES RP-46-23 / TM18 published March 2024 based on over 40 years of research.**

"...circadian clock synchronization is paramount to the body's efficient and appropriate functioning." – TM18



**BioUp solutions maximize WELL points for Circadian Lighting Design (L03):**

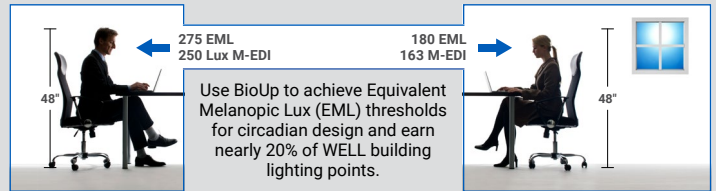

**MDER, M-EDI** and **EML** are key metrics used to quantify non-visual performance of indoor lighting systems.

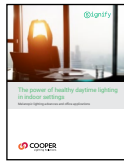

See [BioUp white paper](#) for more details

## 30% boost Biological impact compared to traditional LED sources

**MDER** - Melanopic Daylight Efficacy Ratio (MDER) measures the amount of light stimulating to the melanopsin receptors.

**Standard 4000K LED**  
MDER = .62

**BioUp 4000K LED**  
MDER = .82

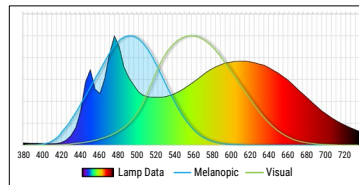
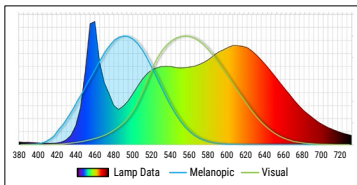

CCT	LED @ ~83 CRI	BioUp Static		BioUp Dynamic	
		MDER	CRI	MDER	CRI
2700K	0.45	-	-	0.43	95
3000K	0.50	-	-	0.57	94
3500K	0.57	0.71	90	0.71	90
4000K	0.65	0.84	87	0.84	87
5000K	0.79	1.00	84	1.00	84

BioUp enhances the LED spectrum with cyan light at 475nm increasing the biological impact of the light to enhance our circadian rhythm which regulates our sleep/wake cycle, daytime engagement, and mood – **all without distorting visual color impression.**

### Static (non-tunable)

Static BioUp is used when simple Melanopic Lighting is desired at all times.

Arrow in graph shows BioUp spectrum boost is at 475nm where non-visual biological response is enhanced.

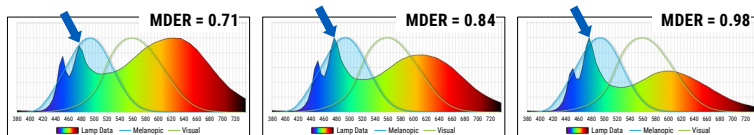

**3500K** or **4000K** or **5000K**

Cyan light component always present



> no CCT control needed

### Dynamic - (Tunable)

Dynamic BioUp is used when Melanopic Lighting is desired to adjust during the day.

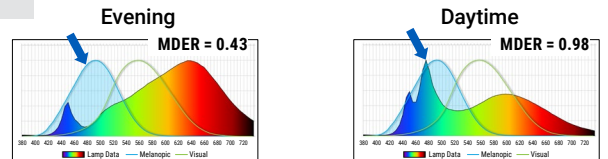

Warmer CCT Without Cyan content ← → Cooler Light With Cyan content

**2700K – 5000K**



> Control with Wavelinx, 2ch 0-10V, or DALI