

Project		Catalog #		Type	
Prepared by		Notes		Date	

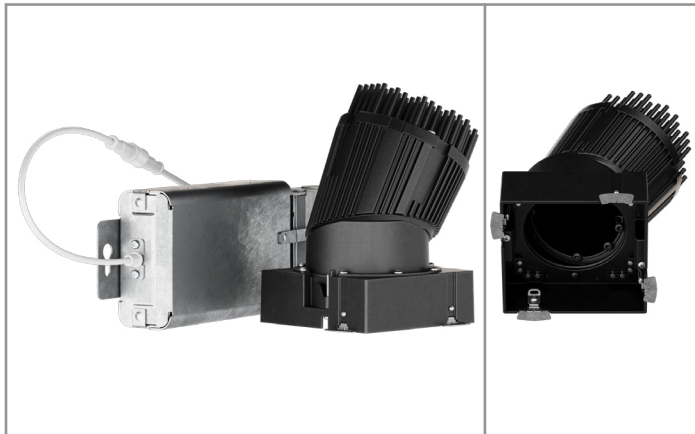

IRiS

P3SQART

3" Square Adjustable Accent
Install from Below

Typical Applications

Residential • Hospitality • Retail • Office • Education • Healthcare

Interactive Menu

- Order Information [page 2](#)
- Product Specifications [page 4](#)
- Energy & Performance Data [page 7](#)
- Photometric Data [page 8](#)
- Connected Systems [page 10](#)
- Product Warranty



Top Product Features

- Install-from-below adjustable downlight for remodel or new construction applications
- Interchangeable optics: 8°, 12°, 10°–70° in 5° increments, and asymmetric patterns
- Available in 250 to 1700 lumens
- Offered in 90, 97, and 98 CRI
- Media holder accepts two lens media
- 2400K, 2700K, 3000K, 3500K, 4000K, 5000K; 1 SDCM
- D2W™ Dim-to-Warm option from 3000K to 1850K
- W2N™ Tunable White CCT range 2700K to 6500K or 2000K to 5000K
- BioUp™ Melanopic Lighting in Tunable White (2700K to 5000K) or Static White
- Options to meet Buy American and other domestic preference requirements

Dimensional and Mounting Details

[additional product diagrams](#)

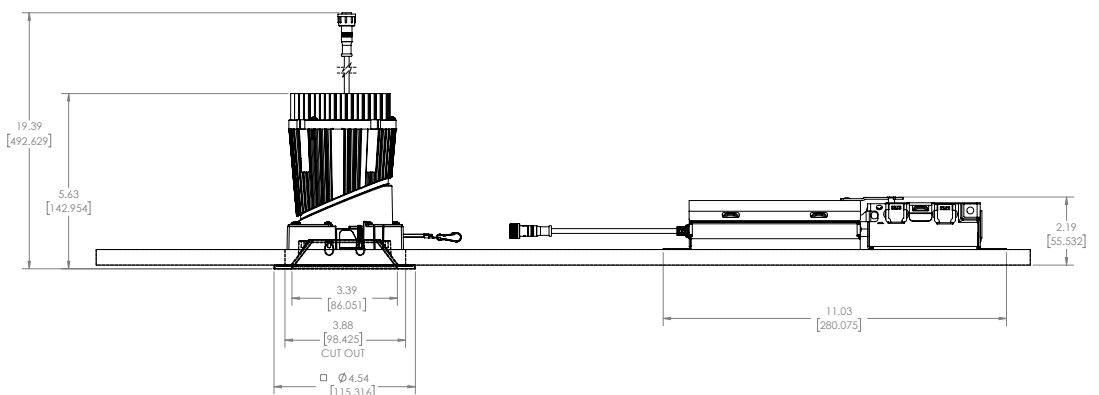

Order Information

SAMPLE ORDER NUMBER: P3SQART09R259030DTR E3SQCBUSR1MW

Domestic Preferences ⁽⁶⁾	Fixture	Lumens <small>(Nominal Lumens will vary depending on selected color, CRI, driver and reflector finish)</small>	Optics ⁽¹⁾⁽²⁾	CRI / CCT	Driver Voltage / Control	
<p>[blank] = Standard BAA = Buy American Act TAA = Trade Agreements Act</p>	<p>P3SQART = 3" Square 45° Adjustable Accent, Install-from-below</p> <p>P3SQARTKE = 3" Square 35° Adjustable Accent, Install-from-below for Knife edge rimless plaster installations (Order accessory separately)</p>	<p>90/97/98 CRI</p> <p>IC Rated 02 = 250 lm 05 = 500 lm 09 = 900 lm (Non-IC with 10° & 12° optic)</p> <p>Non-IC Rated 13 = 1300 lm 17 = 1700 lm (90/97 CRI)</p> <p>D2W™ Dim-to-Warm ⁽¹⁾⁽²⁾ IC Rated 02 = 250 lm 05 = 500 lm Non-IC Rated 09 = 900 lm 13 = 1300 lm</p> <p>W2N™ Tunable White ⁽¹⁾⁽²⁾ IC Rated 05 = 500 lm</p> <p>BioUp™ Melanopic Lighting ⁽¹⁾⁽²⁾ IC Rated 05 = 500 lm</p>	<p>[blank] = Order optic separately (Available for ≥15°)</p> <p>R08 = 8° (Offered in 250 lm; Requires DE010 or D5LT driver) ⁽³⁾</p> <p>R10 = 10° (Offered for 250-900 lm) ⁽³⁾</p> <p>R12 = 12° (Offered ≤900 lm) ⁽³⁾</p> <p>R15 = 15° R20 = 20° R25 = 25° R30 = 30° R35 = 35° R40 = 40° R45 = 45° R50 = 50° R55 = 55° R60 = 60° R65 = 65° R70 = 70° (select when using wall wash reflector)</p> <p>Asymmetric Elliptical 2R2040 = 20° x 40° 2R2050 = 20° x 50° 2R2060 = 20° x 60°</p>	<p>90 CRI (min) 9024 = 2400K 9027 = 2700K 9030 = 3000K 9035 = 3500K 9040 = 4000K 9050 = 5000K</p> <p>97 CRI (min) 9727 = 2700K 9730 = 3000K 9735 = 3500K 9740 = 4000K</p> <p>98 CRI (250-1300 lm only) 9824 = 2400K 9827 = 2700K 9830 = 3000K 9835 = 3500K 9840 = 4000K</p>	<p>D2W™ Dim-to-Warm (≤1300 lm) 9030D2W = Dim-to-Warm, 3000K-1850K</p> <p>W2N™ Tunable White Specify with DE010, D5LT or LD2 driver; remote driver only</p> <p>W2N902050 = Tunable white, 2000K-5000K W2N902765 = Tunable white, 2700K-6500K</p> <p>BioUp™ (Remote driver only) B2750 = BioUp™ boosted cyan tunable white, 2700K - 5000K (Specify with DE010 or D5LT driver) B35 = Static BioUp™, 3500K (DE010 driver only) B40 = Static BioUp™, 4000K (DE010 driver only) B50 = Static BioUp™, 5000K (DE010 driver only)</p>	<p>Phase Cut Dimming DTR = 120V phase cut 1% dimming</p> <p>0-10V Dimming D010 = UNV 120-277V, 0-10V 1% dimming 3D010 = 347V, 0-10V 1% dimming (900-1700 lm) DE010 = UNV 120-277V, 0-10V linear, 0.1% dimming (≥250lm for D2W and ≥500 lm for other CRI/CCT)</p> <p>DALI & Lutron® EcoSystem™ D5LT = UNV 120-277V DALI DT6 logarithmic 0.1% dimming (≥250lm for D2W and ≥500 lm for other CRI/CCT) DLE = UNV 120-277V Lutron® EcoSystem™ 1% dimming (900-1700 lm)</p> <p>DMX ⁽⁴⁾ (Order remote driver separately) DMX = UNV 120-277V DMX/RDM logarithmic 0.1% (≥250lm for D2W and ≥500 lm for other CRI/CCT) DMXC5 = UNV 120-277V DMX/RDM logarithmic 0.1% dimming with RJ45 connection remote driver only (≥250lm for D2W and ≥500 lm for other CRI/CCT)</p>

Driver Options	Options ⁽⁵⁾
<p>[blank] = Integral driver (Offered with DTR, D010, 3D010, DE010 DLE and D5LT)</p> <p>R = Remote driver (Order remote driver separately; Required for DMX, BioUp™ and W2N™ Tunable White)</p>	<p>WaveLinX (Factory installed) WLN = WaveLinX LITE Wireless Node without sensor (Specify with DE010 or D010 driver) WPN = WaveLinX PRO Wireless Node without sensor (Specify with DE010 or D010 driver)</p> <p>Lutron® Athena™ AWN = Lutron® Athena™ Wireless Node (Specify with D010, DE010, or LD2 driver)</p>

Square Die cast Aluminum and Non-conductive Trims <small>(Standard self-flanged & Knife edge rimless plaster)</small>		Lens <small>(Required for outdoor use)</small>	Flange Style and Finish	Reflector Finish
<p>STANDARD SELF-FLANGED TRIMS (Use with Self-flanged Styles 1, 2, or 5)</p> <p>Downlight & Adjustable E3SQCBUSR = 3" Shallow bevel E3SQPHUSR = 3" Ultra-shallow pinhole E3SQCSAR = 3" Super adjustable</p> <p>Wall Wash (Specify with 70° optic) E3SQCLSWWR = 3" Lensed single wall wash E3SQCLDWR = 3" Lensed double wall wash</p> <p>Non-Conductive (Use with Self-flanged Styles 1; Select Matte Black or Matte White finish; Lens selection required) E3SQPBR = 3" Bevel, Dead front</p>	<p>KNIFE EDGE TRIMS (Use with Flange Style 4)</p> <p>Downlight & Adjustable E3SQCBUS = 3" Shallow bevel E3SQPHUS = 3" Ultra-shallow pinhole E3SQCSA = Super adjustable</p> <p>Wall Wash (Specify with 70° optic) E3SQCLSWW = 3" Lensed single wall wash E3SQCLDWW = 3" Lensed double wall wash</p> <p>Non-Conductive (Select Matte Black or Matte White finish; Lens selection required) E3SQPB = 3" Bevel, Dead front</p>	<p>[blank] = Open, lensed wall wash or super adjustable</p> <p>Lenses (Required for outdoor use) L = Textured clear lens LP = Prismatic lens LD = Diffuse lens</p>	<p>[blank] = Pinhole</p> <p>1 = Self-flanged (Flange matches reflector finish) 2 = Self-flanged (Flange is painted Matte White) 4 = Knife edge rimless for plaster (Requires Rimless plaster lathing ring accessory) 5 = Self-flanged (Flange is painted Matte Black)</p>	<p>MW = Matte White MB = Matte Black MMS = Matte Metallic Silver BZ = Bronze</p>

Continued on next page.

Order Information

Optics and Media Accessories		
Optics	Media Filters	Lens Options
2R15SP = 15° Beam 2R20 = 20° Beam 2R25NFL = 25° Beam 2R30 = 30° Beam 2R35 = 35° Beam 2R40FL = 40° Beam 2R45 = 45° Beam 2R50 = 50° Beam 2R55WFL = 55° Beam 2R60 = 60° Beam 2R65 = 65° Beam 2R70 = 70° Beam Asymmetric Elliptical 2R2040 = 20° x 40° 2R2050 = 20° x 50° 2R2060 = 20° x 60°	L112 = Red gel filter L114 = Ultraviolet dichroic filter L120 = Red dichroic filter L121 = Amber dichroic filter L122 = Yellow dichroic filter L123 = Green dichroic filter L124 = Daylight blue dichroic filter L125 = Blue dichroic filter L127 = Cosmetic (2700K) dichroic filter L131 = Amber gel filter	L110N = Diffuse Sandblasted Lens L111 = Soft Focus Lens L113 = Prismatic Spread Lens L115 = Linear Spread Lens L100MB = Hex Cell Louver

Accessories		
Knife Edge Rimless Trim Installations (Required for use with Knife Edge rimless trim reflectors for plaster) RPRSQ3 = Square rimless plaster lathing ring	WaveLinX Sensor Kits WPST = Field-installed WaveLinX PRO Sensor Kit WLST = Field-installed WaveLinX LITE Sensor Kit	New Construction Mounting Frame (Galvanized steel frame with 3/8" drywall collar for precise hole locating and cutting, integral bar hangers (7.25"-24") for traditional framing and T-grid ceilings, and captive thumbscrews for toolless driver/junction box attachment during rough-in) PMFSQ3 = 3" Mounting frame for use in traditional framing and T-grid ceiling

Required if remote driver (R) is specified

Remote driver				
Domestic Preferences ⁽¹⁾	Flexible Metal Clad Conduit with Wires	Lumens	Color Control	Driver
[blank] = Standard BAA = Buy American Act TAA = Trade Agreements Act	RN100 = Remote 100ft RN50 = Remote 50ft RN25 = Remote 25ft RN15 = Remote 15ft RN5 = Remote 5ft RN2 = Remote 2ft	IC Rated 02 = 250 lm 05 = 500 lm 09 = 900 lm Non-IC Rated 13 = 1300 lm 17 = 1700 lm	[blank] = 90, 97 and 98 CRI (98 CRI, offered up to 1300 lm) D2W™ Dim-to-Warm 9030D2W = Dim-to-Warm, 3000K-1850K (90 CRI min, offered up to 1300 lm) W2N™ Tunable White (Specify with D5LT or DE010 driver) W2N902050 = Tunable white, 2000K-5000K CCT (500 lm) W2N902765 = Tunable white, 2700K-6500K CCT (500 lm) BioUp™ Melanopic Lighting (Specify with D5LT or DE010 driver) B2750 = Boosted cyan tunable white BioUp™ 2700K-5000K (500 lm) B35 = Static BioUp™ 3500K (500 lm, DE010 only) B40 = Static BioUp™ 4000K (500 lm, DE010 only) B50 = Static BioUp™ 5000K (500 lm, DE010 only)	Phase Cut Dimming DTR = 120V phase cut 1% dimming 0-10V Dimming D010 = UNV 120-277V, 0-10V 1% dimming 3D010 = 347V 0-10V 1% dimming (900-1700 lm) DE010 = UNV 120-277V, 0-10V linear, 0.1% dimming (500-1700 lm, remote only) DALI & DMX D5LT = UNV 120-277V DALI DT6 logarithmic 0.1% dimming (500-1700 lm) DMX = UNV 120-277V DMX/RDM logarithmic 0.1% dimming ⁽⁴⁾ DMXC5 = UNV 120-277V DMX/RDM logarithmic 0.1% dimming with RJ45 connection ⁽⁴⁾ Lutron® Ecosystem™ & DALI DLE = UNV 120-277V Lutron® EcoSystem™ 1% dimming (900-1700 lumen, limited to 25ft)

Remote driver
Options
Emergency Battery Backup EMB0D6ST = Bodine® 7W Emergency Module with Remote Test Switch (≥500 lm) EM7 = 7W Integral Emergency Backup Battery with Remote Test Switch (≥900 lm) EM14 = 14W Integral Emergency Backup Battery with Remote Test Switch (≥1700 lm) EM14RSD = 14W Self Diagnostic Replaceable Emergency Battery Pack with Remote Test Switch (≥1700 lm) ETRD = Emergency Transfer Device WaveLinX (Factory installed) WPST = Factory-installed WaveLinX PRO sensor kit WLST = Factory-installed WaveLinX LITE sensor kit WPN = WaveLinX PRO Wireless Node without sensor (Specify with DE010 or D010 driver) WLN = WaveLinX LITE Wireless Node without sensor (Specify with DE010 or D010 driver) Lutron® Athena™ AWN = Lutron® Athena™ Wireless Node (Specify with DE010 or D010 driver)

- Notes:**
- Optic accommodates 2 media with 90, 97, and 98 CRI and 1 media with D2W™, W2N™, and BioUp™.
 - D2W™, W2N™, and BioUp™ are offered with ≥15° optics.
 - Optic must be specified with the housing for ≤12°
 - DMX fixtures default to full ON upon loss of DMX signal
 - Non-IC

Product Specifications

Module

- One-piece design installs from below the ceiling using integral mounting clamps that tighten with a #2 Phillips screwdriver, allowing for easy, precise adjustment.
- Standard module designed to accommodate ceiling thicknesses ranging from 1/2" to 1-1/4"; Knife edge module accommodates 1/2" to 13/16".
- Overspray protector comes pre-installed to safeguard the unit from plaster and paint during installation.
- Painted matte black for a visibly dark interior.

Thermal Management/Heat Sink

- High-performance forged aluminum heat sink efficiently dissipates heat from the LED array, ensuring optimal thermal management and longer life.
- Heat sink and LED assembly are designed for convenient servicing and maintenance from below the ceiling.

Junction Box

- Four 1/2" conduit pry-outs
- Lever nut connectors for simple and fast wiring
- Barrier for separation of low-voltage (0-10V) wires.

Optional Mounting Frame

- Galvanized steel mounting frame with offset aperture and 3/8" drywall collar for hole location includes a notch at 90° intervals for laser centering
- Mounting flange levels frame with ceiling
- Locking screws provide positive horizontal locking
- Bar hangers adjust from 8" to 24" wide with pass through feature to shorten without removal
- Captive nail penetrates standard and engineered lumber
- Integral clip attaches directly to tee-bar.

Adjustment

- 45° for regular configuration, 35° for Knife edge configuration tilt capability for versatile aiming options.
- Locks firmly in place at any angle to ensure stable and accurate aiming.
- Integrated aiming scale allows for uniform and repeatable adjustments across multiple fixtures.

LED Array

- Proximity phosphors over chip on board LEDs provide a uniform source with high-efficiency and no pixilation.
- Available in 2400K, 2700K, 3000K, 3500K, 4000K, and 5000K CCTs, 90 CRI min, R9 >50.
- 90/97 CRI color accuracy within 1 SDCM (for 12° and above distributions). L78 55,000 hours.
- Optional full-spectrum CCTs at 2400K, 2700K, 3000K, 3500K, and 4000K CCT, 98 CRI min, R1-R15 values ranging from 92–100, excellent TM-30 metrics, Rf ranging from 96–98, and Rg from 99–100; L70 55,000 hours.
- D2W™ Dim-to-Warm smoothly shifts from 3000K down to an ultra-warm 1850K as you dim, creating the cozy, relaxing glow people expect from high-end lighting—without the energy waste or heat of old sources (90 CRI min).
- W2N™ Tunable White: 2700K to 6500K or 2000K to 5000K (90 CRI min)

- BioUp™ Melanopic Lighting in tunable white (2700K to 5000K) or static CCTs (3500K, 4000K, and 5000K) provides the biological effectiveness of natural sunlight, with color temperatures that are more comfortable for indoor environments*

Optic

- Polarized turn-and-lock optics enable precise alignment to the light source, facilitating quick aiming and focusing adjustments in the field.
- Designed to deliver uniform beam patterns with distribution options of 8°, 10° to 70° in 5° increments, and asymmetric patterns for versatile lighting applications.
- Asymmetric beam options in 20°×40°, 20°×50°, and 20°×60° distributions provide precise, application-driven light coverage
- Integrated media holder accommodates one or two 2" diameter media components, including 3.0mm thick color filters, lenses, or louvers. (One media with D2W™, W2N™, and BioUp™)

Trims

- Install-from-below trims are available in either Knife edge rimless for plaster or standard width self-flanged versions.
- Trims are effortlessly secured using 16 neodymium magnets for reliable installation and easy adjustments.
- A concealed tether keeps trims secured to the housing during installation or maintenance, preventing accidental drops and protecting finished spaces.
- Field-changeable open and lensed trims are offered for downlight, wall wash, or pinhole aperture configurations to suit various lighting needs.
- Lensed trims are wet location listed, making them suitable for use in showers and steam room applications.
- Lens options include prismatic, diffuse, and lightly textured translucent clear finishes.
- Lensed Wall Wash trims are available in single, double and corner wall wash designs, delivering uniform vertical illumination with minimal visible source brightness.
- Super Adjustable trim provides adjustable tilt between 15° and 75°, ideal for highlighting features in spaces with sloped ceilings.
- Knife edge rimless plaster lathing ring accessory provides a flush transition and snaps to the plaster collar.

Driver - Remote or integral

- Standard UNV 120-277V or 347V constant current drivers provide noise-free operation in continuous, flicker-free 0-10V analog control dimming from 100% to either 1% or 0.1%.
- 120V, flicker-free dimming from 100% to <1% with phase cut control
- Driver options also include DALI, DMX, and Lutron®
- Lutron® options include EcoSystem™ and Lutron® DALI.
- Integral driver has quick disconnect for easy replacement

WaveLinX Connected Lighting System

Choose from WaveLinX PRO or LITE connected solutions. Refer to WaveLinX system specifications and application guides for details.

[WaveLinX PRO Tilemount Sensor Kit](#)

- Offers daylight dimming, PIR motion sensing, scene and zone configuration, and automatic commissioning; and optional RLTS - Real Time Location Services available.

[WaveLinX PRO Wireless Node](#)

- Provides luminaire-level control with scene and zone configuration without an integrated sensor; Connects wirelessly with daylight dimming sensor and PIR motion sensor if desired. Use with 0-10V drivers only. Note: Not compatible with 347V or Chicago plenum.

[WaveLinX LITE Tilemount Sensor Kit](#)

- Offers daylight dimming and PIR motion sensing, scene and grouping configuration.

[WaveLinX LITE Wireless Node](#)

- Provides luminaire level control with scene and zone configuration without an integrated sensor; Connects wirelessly with daylight dimming sensor and PIR motion sensor if desired. Use with 0-10V driver only. **Note:** Not compatible with 347V or Chicago plenum.

[WaveLinX Tilemount Sensor Kit \(WPST & WLST\)](#)

[Applications:](#)

- Include a control module mounted on the luminaire junction box via 1/2" knock-out, and a tilemount sensor on a 54" whip; for ceiling installation by direct-mount spring clips or via mounting bracket in octagon ceiling boxes.
- May be ordered as factory installed on the luminaire, or ordered separately as a field-installed accessory kit.
- **Note: WaveLinX PRO devices are only compatible with the WaveLinX PRO system.**
- **Note: WaveLinX LITE devices are only compatible with the WaveLinX LITE system.**

[Compliance](#)

- cULus Certified to UL 1598 / C22.2 No. 250 suitable for wet locations with lensed trims (required for outdoor use); damp location with open trims.
- Wet location and steam room (up to 40°C / 104°F, up to 500 lumens; 25°C up to 1700 lumens), covered ceilings only and IP65, below the ceiling only with lensed trims
- cULus listed for 25°C ambient environments
- Insulation contact (IC) rated (for direct contact with air permeable insulation) and non-IC rated (Refer to ordering information table)
- Airtight per ASTM-E283 (with lensed trims)
- FCC CFR Title 47 Part 15 Class B at 120VAC and Class A at 277VAC
- Declare compliant, LBC Red List approved
- RoHS compliant
- Photometric testing in accordance with IES LM-79-08
- Lumen maintenance projections in accordance with IES LM-80-08 and TM-21-11
- Can be used for State of California Title 24 high efficacy LED compliance under JA8, reference Modernized Appliance Efficiency Database System (MAEDBS) for 2019 JA8 High Efficacy Lighting.

[Warranty](#)

- Five year limited warranty, consult website for details. www.cooperlighting.com/legal

Dimensional and Mounting Details

SQUARE ADJUSTABLE SELF FLANGE

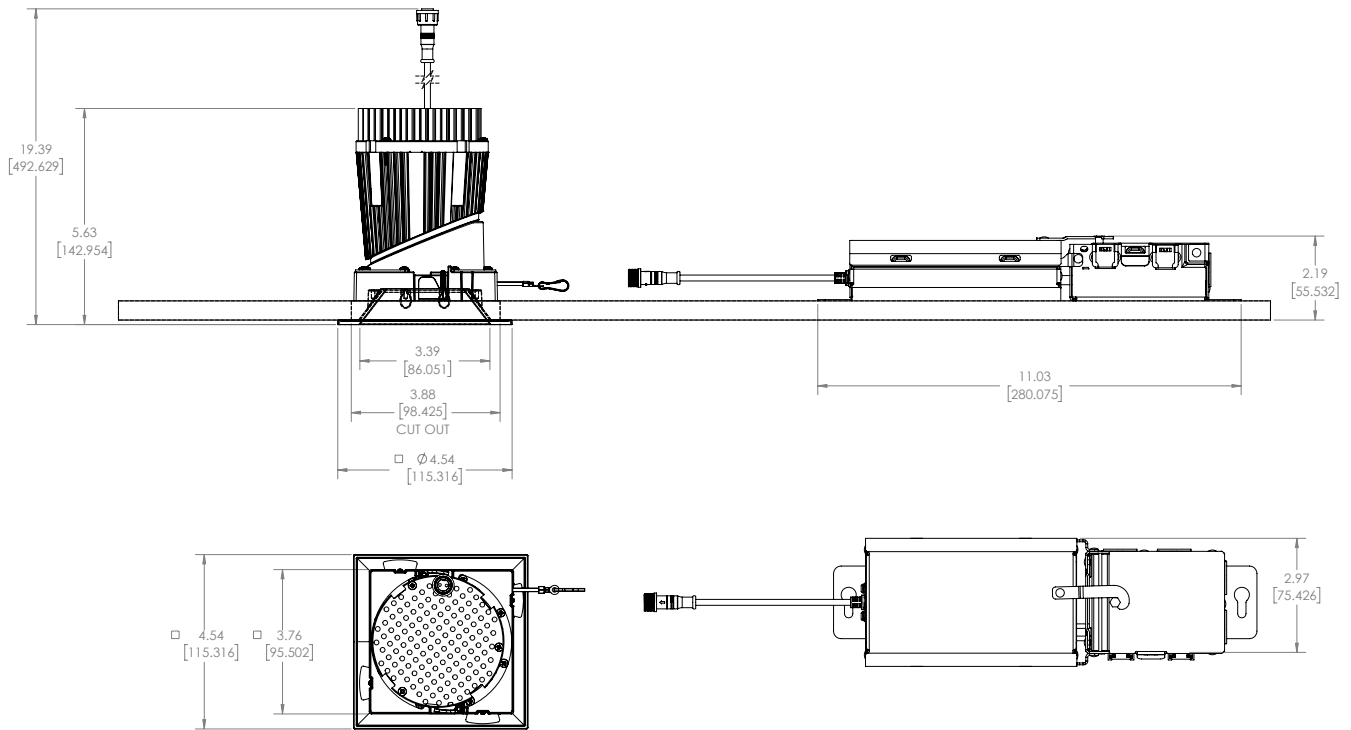

SQUARE ADJUSTABLE KNIFE EDGE

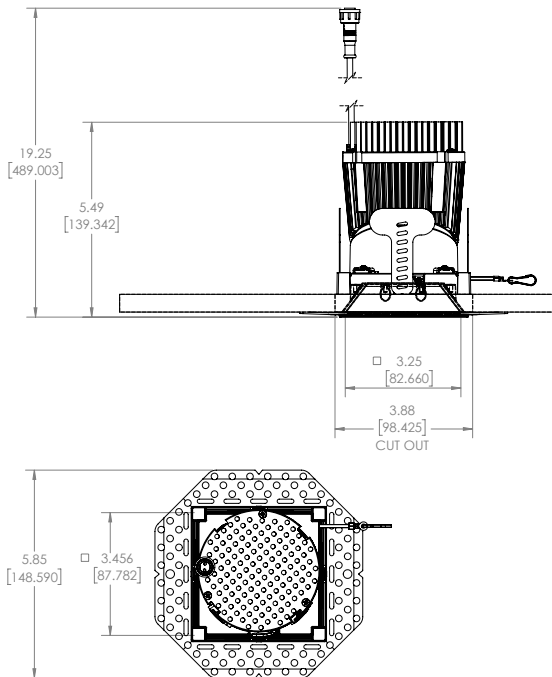

MOUNTING FRAME ACCESSORY

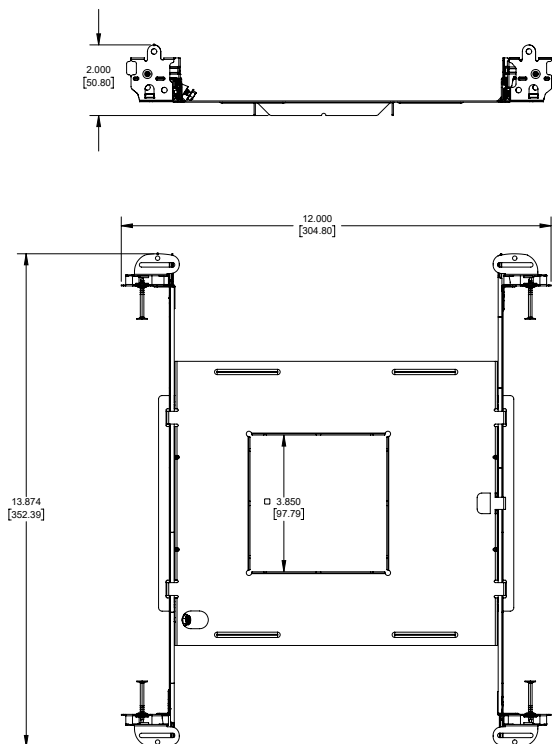

Trim Finishes

Square Painted Finishes



Matte Black
(MB)



Matte White
(MW)



Bronze
(BZ)



Matte Metallic Silver
(MMS)

Trim Type

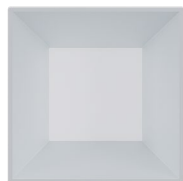

Knife Edge
for Millwork and Plaster

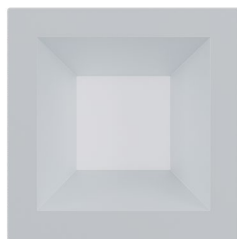

Standard Flange

Energy and Performance Data

DTR DRIVER ENERGY DATA

	250 lumen	500 lumen	900 lumen	1300 lumen	1700 lumen
Input Power (W)	4.2	8.7	13.5	16.5	23.3
Input Current (A)	0.04	0.07	0.11	0.14	0.19
PF	>0.9	>0.9	>0.9	>0.9	>0.9
THDi (%)	18.01	7.8	7.64	8.32	7.6
Inrush Current (A)	1.6	1.7	4.9	0.5	4.8
Inrush Duration (µs)	33	30	33	32	30
Sound (dBA)	<22	<22	<22	<22	<22

D010 DRIVER ENERGY DATA

	250 lumen		500 lumen		900 lumen		1300 lumen		1700 lumen	
	120V	277V	120V	277V	120V	277V	120V	277V	120V	277V
Input Power (W)	5.1	5.3	7.2	7.6	11.7	11.9	15.6	16.0	21.4	21.5
Input Current (A)	0.04	0.02	0.06	0.03	0.10	0.05	0.13	0.06	0.18	0.08
PF	>0.9	>0.9	>0.9	>0.9	>0.9	>0.9	>0.9	>0.9	>0.9	>0.9
THDi (%)	18.7	19.0	8.25	12.8	6.96	9.2	6.11	10.2	6.74	8.1
Inrush Current (A)	4.5	9.7	4.6	10.5	4.6	10.5	5.2	11.9	5.3	11.9
Inrush Duration (µs)	41	19	43	19	43	19	40	19	46	17
Sound (dBA)	<22	<22	<22	<22	<22	<22	<22	<22	<22	<22

Minimum starting temperature -30°C (-22°F)*
(Nominal input 120-277VAC & 100% of rated output power)

Sound Rating: Class A standards

Notes:
Emergency Battery packs are rated for a minimum starting temperature of 0°C.

COLOR METRICS - TM-30-18 & CRI/CIE

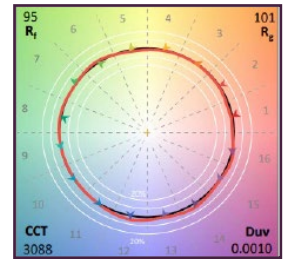
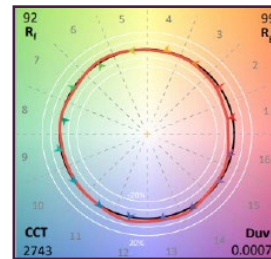
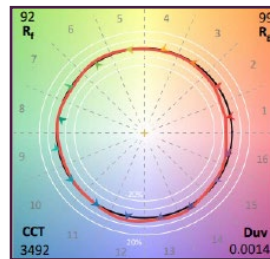
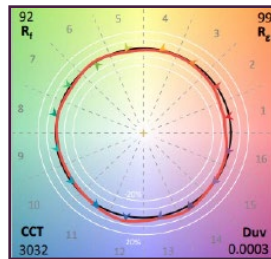
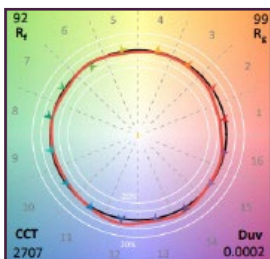

9027		
TM-30-18	R _f	92
	R _g	99
CRI/CIE	R _a	92
	R ₉	50

9030		
TM-30-18	R _f	92
	R _g	99
CRI/CIE	R _a	93
	R ₉	51

9035		
TM-30-18	R _f	92
	R _g	99
CRI/CIE	R _a	93
	R ₉	58

9727		
TM-30-18	R _f	92
	R _g	99
CRI/CIE	R _a	97
	R ₉	85

9730		
TM-30-18	R _f	101
	R _g	95
CRI/CIE	R _a	97
	R ₉	83

Photometric Data

E3SQCBUS1MW		250 lm	500 lm	900 lm	1300 lm	1700 lm
R08 8° Optic	CBCP	6471	#N/A	#N/A	#N/A	#N/A
	Lumens	247	#N/A	#N/A	#N/A	#N/A
	LPW	51.0	#N/A	#N/A	#N/A	#N/A
	UGR*	0	0	0	0	0
R10 10° Optic	CBCP	6454	13265	19947	#N/A	#N/A
	Lumens	291	558	767	#N/A	#N/A
	LPW	77.5	70.3	61.4	#N/A	#N/A
	UGR*	0	0	0	0	0
R12 12° Optic	CBCP	4607	9469	13950	18381	#N/A
	Lumens	308	621	915	1126	#N/A
	LPW	83.7	82.1	78.2	72.6	#N/A
	UGR*	0	0	0	0	0
R15 15° Optic	CBCP	5580	11468	17245	22261	29491
	Lumens	310	638	959	1238	1641
	LPW	86.4	88.1	86.4	84.9	77.4
	UGR*	0	0	0	0	0
R20 20° Optic	CBCP	4311	8860	13322	17198	22784
	Lumens	315	647	974	1257	1665
	LPW	87.8	89.4	87.7	86.1	78.5
	UGR*	0	0	0	0	0
R25 25° Optic	CBCP	3356	6897	10372	13389	17738
	Lumens	320	657	989	1276	1690
	LPW	89.0	90.8	89.1	87.4	79.7
	UGR*	0	0	0	0	0
R30 30° Optic	CBCP	2277	4680	7038	9085	12036
	Lumens	316	649	977	1261	1670
	LPW	88.0	89.7	88.0	86.3	78.7
	UGR*	0	0	0	0	0
R35 35° Optic	CBCP	1845	3792	5702	7361	9752
	Lumens	312	642	965	1246	1650
	LPW	86.9	88.6	86.9	85.3	77.9
	UGR*	0	0	0	0	0
R40 40° Optic	CBCP	1617	3325	5000	6454	8551
	Lumens	346	712	1071	1382	1831
	LPW	96.4	98.4	96.5	94.7	86.4
	UGR*	0	0	0	0	0
R45 45° Optic	CBCP	1176	2416	3634	4691	6215
	Lumens	330	679	1022	1319	1748
	LPW	92.0	93.8	92.1	90.3	82.4
	UGR*	0	0	0.6	1.6	2.6

Photometric Data

E3SQCBUS1MW		250 lm	500 lm	900 lm	1300 lm	1700 lm
R50 50° Optic	CBCP	1100	2262	3401	4391	5816
	Lumens	343	706	1061	1370	1815
	LPW	95.5	97.5	95.6	93.8	85.6
	UGR*	0	0	0.3	1.3	2.3
R55 55° Optic	CBCP	849	1743	2621	3384	4483
	Lumens	321	658	990	1278	1693
	LPW	89.3	90.9	89.2	87.6	79.9
	UGR*	0	0.4	1.7	2.7	3.7
R60 60° Optic	CBCP	712	1463	2199	2839	3762
	Lumens	311	640	962	1242	1646
	LPW	86.6	88.4	86.7	85.1	77.7
	UGR*	0.9	3.4	4.7	5.7	6.7
R65 65° Optic	CBCP	724	1489	2239	2890	3829
	Lumens	293	602	904	1167	1546
	LPW	81.5	83.1	81.4	80.0	72.9
	UGR*	2.1	4.6	5.9	6.9	7.9
R70 70° Optic	CBCP	526	1081	1626	2099	2780
	Lumens	299	616	926	1196	1584
	LPW	83.4	85.1	83.4	81.8	74.7
	UGR*	5.6	8.1	9.4	10.4	11.4

MULTIPLIER

	2400K	2700K	3000K	3500K	4000K	5000K
90 CRI	0.86	0.91	0.97	1.00	1.05	1.06
97 CRI	0.83	0.86	#N/A	#N/A	#N/A	#N/A
98 CRI	#N/A	0.65	0.70	0.76	0.80	0.78

Connected Systems

WaveLinx LITE - WLST Tilemount Sensor

WaveLinx LITE devices only compatible with the WaveLinx LITE system.

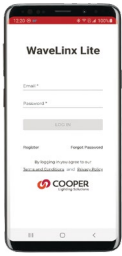

- Intuitive Android™ or Apple® iOS® app for basic system code compliant set up and configuration via Bluetooth
- Up to 28 unique areas per project site (WaveLinx LITE Bluetooth network)
- Up to 50 devices for an area, any one of 16 control zones, up to 6 occupancy sets, and custom lighting scenes
- Automatic occupancy or vacancy, sensor sensitivity, daylight dimming, etc. configurable through the app
- Refer to the WaveLinx system specifications for details



WaveLinx LITE WLST Tilemount Wiring Diagram

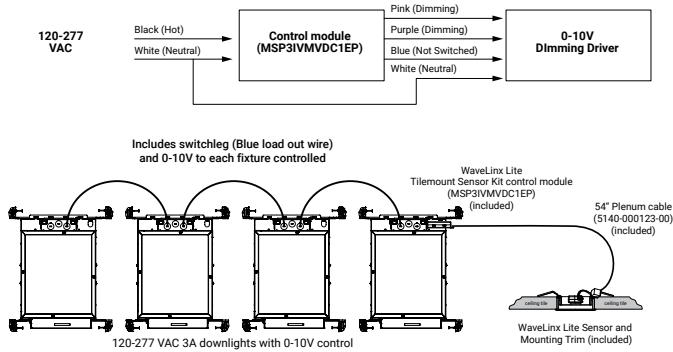

WaveLinx LITE Bluetooth Enabled System

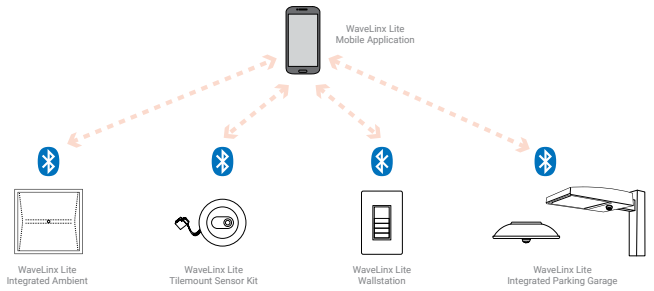

WaveLinx PRO Wireless – WPST Tilemount Sensor

WaveLinx PRO devices only compatible with the WaveLinx PRO system.



- WaveLinx PRO Wireless functionality configures zones and customizes settings from one secure mobile app
- Automatic code commissioning that meets the strictest codes
- Fixtures and sensors integrate with Wireless Area Controller, Wall Stations, and Control Devices
- Stand-Along Offices or Entire Building Network Installations



WaveLinx mobile app settings

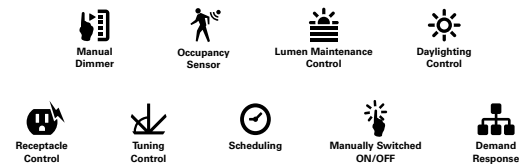

WaveLinx PRO WPST Tilemount Wiring Diagram

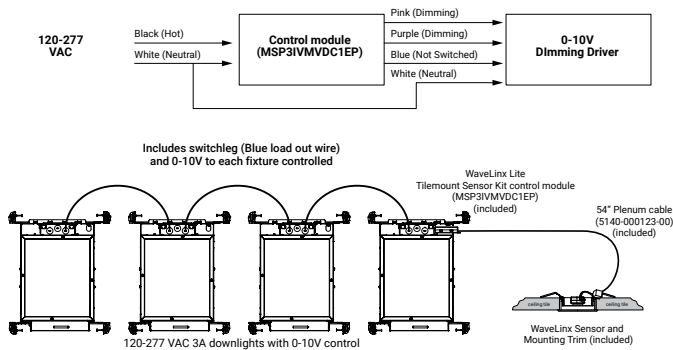

WaveLinx CORE Building Management Integration

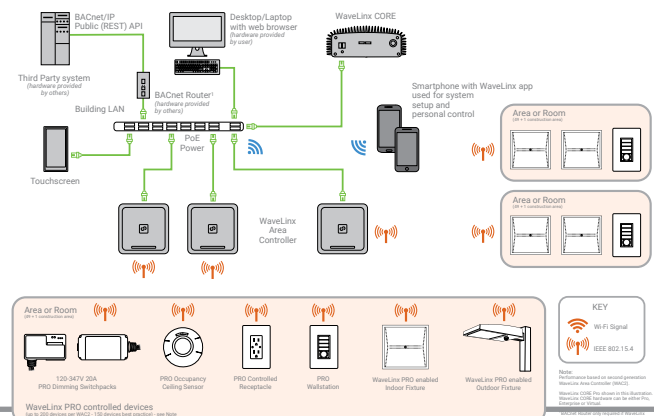

Connected Solutions



WaveLinX LITE Wireless Node - WLN

WaveLinX LITE devices only compatible with the WaveLinX LITE system.

- Intuitive Android™ or Apple® iOS® app for basic system code compliant set up and configuration via Bluetooth
- Up to 28 unique areas per project site (WaveLinX LITE Bluetooth network)
- Up to 50 devices for an area, any one of 16 control zones, up to 6 occupancy sets, and custom lighting scenes
- Refer to the WaveLinX system specifications for details
- Not available with BioUp or Tunable White

WaveLinX mobile app settings



WaveLinX LITE Wireless Node (WLN) Wiring Diagram

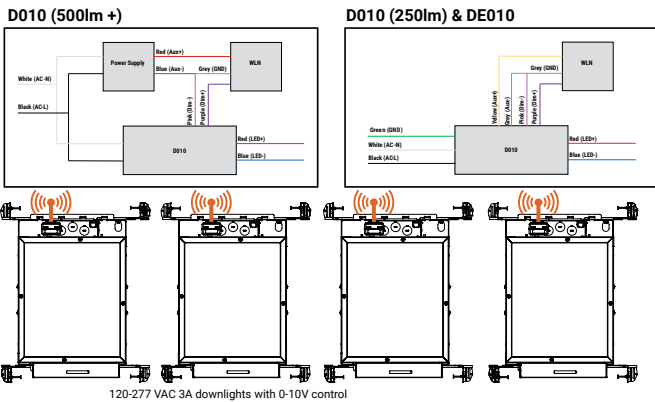

WaveLinX LITE Bluetooth Enabled System

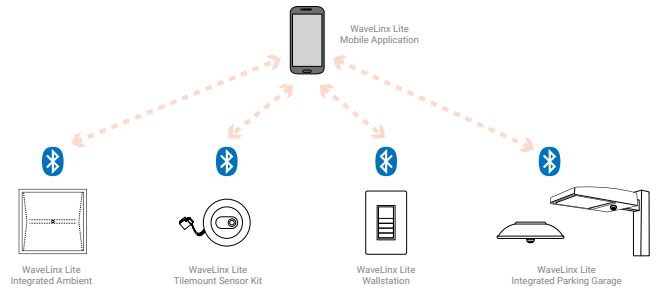

WaveLinX PRO Wireless Node - WPN

WaveLinX PRO devices only compatible with the WaveLinX PRO system.

- WaveLinX Wireless functionality configures zones and customizes settings from one secure mobile app
- Automatic code commissioning that meets the strictest codes
- Fixtures and sensors integrate with WaveLinX Area Controller, Wall Stations, and Control Devices
- Stand-Alone Offices or Entire Building Network Installations

Downlights with wireless communication: Highly efficient LED fixtures

WaveLinX Area Controller: Provides centralized coordination of multiple area control options

Wireless Wall Station/Receptacle: Provides customized wireless control of each area

Mobile Applications: Provides personalized, local control from a tablet or smartphone

WaveLinX mobile app settings

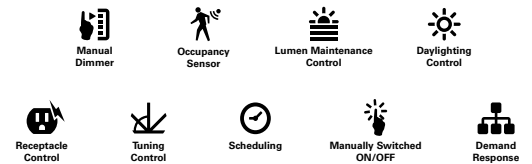

WaveLinX PRO Wireless Node (WPN) Wiring Diagram

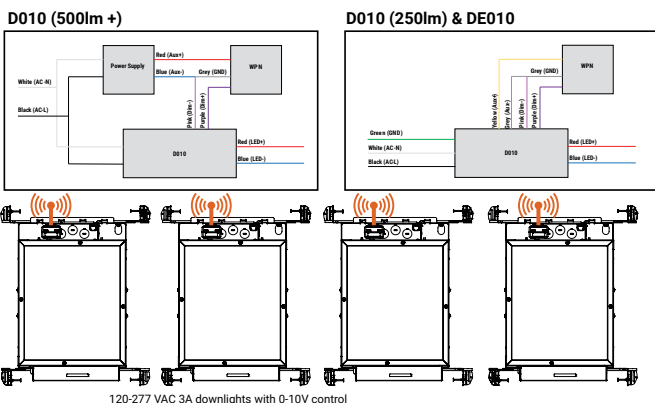

WaveLinX CORE Building Management Integration

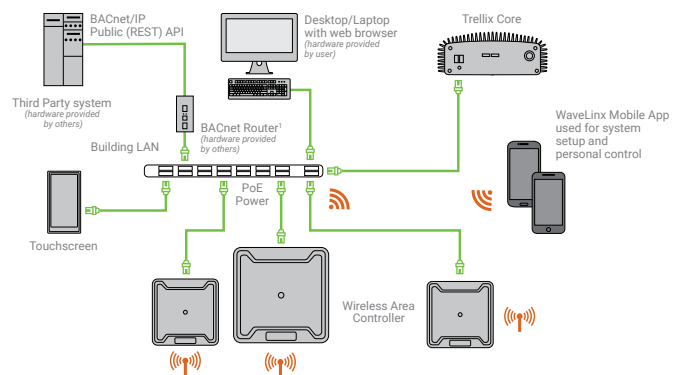

Proven Research. Industry Recognized.

BioUp Melanopic Lighting



See better



Feel better



Function better



See [BioUp brochure](#) for more details



ANSI/IES RP-46-23

RECOMMENDED PRACTICE:
SUPPORTING THE PHYSIOLOGICAL
AND BEHAVIORAL EFFECTS
OF LIGHTING IN INTERIOR
DAYTIME ENVIRONMENTS
AN AMERICAN NATIONAL STANDARD

ANSI/IES RP-46-23 / TM18 published March 2024 based on over 40 years of research.

"...circadian clock synchronization is paramount to the body's efficient and appropriate functioning." – TM18



BioUp solutions maximize WELL points for Circadian Lighting Design (L03):

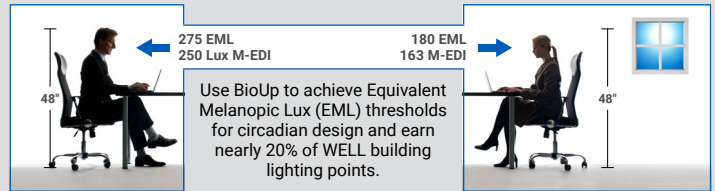

MDER, M-EDI and **EML** are key metrics used to quantify non-visual performance of indoor lighting systems.

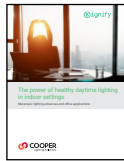

See [BioUp white paper](#) for more details

30% boost Biological impact compared to traditional LED sources

MDER - Melanopic Daylight Efficacy Ratio (MDER) measures the amount of light stimulating to the melanopsin receptors.

Standard 4000K LED
MDER = .62

BioUp 4000K LED
MDER = .82

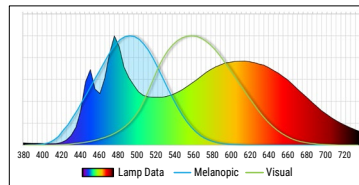
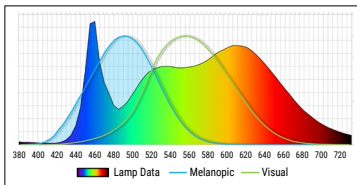

CCT	LED @ ~83 CRI	BioUp Static		BioUp Dynamic	
		MDER	CRI	MDER	CRI
2700K	0.45	-	-	0.43	95
3000K	0.50	-	-	0.57	94
3500K	0.57	0.71	90	0.71	90
4000K	0.65	0.84	87	0.84	87
5000K	0.79	1.00	84	1.00	84

BioUp enhances the LED spectrum with cyan light at 475nm increasing the biological impact of the light to enhance our circadian rhythm which regulates our sleep/wake cycle, daytime engagement, and mood – **all without distorting visual color impression.**

Static (non-tunable)

Static BioUp is used when simple Melanopic Lighting is desired at all times.

Arrow in graph shows BioUp spectrum boost is at 475nm where non-visual biological response is enhanced.

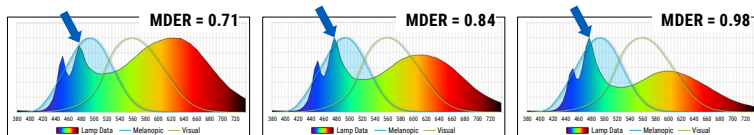

3500K or **4000K** or **5000K**

Cyan light component always present



> no CCT control needed

Dynamic - (Tunable)

Dynamic BioUp is used when Melanopic Lighting is desired to adjust during the day.

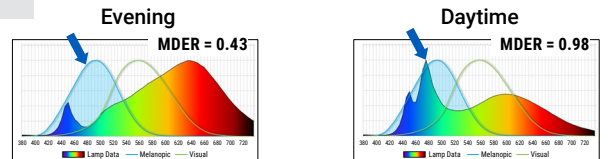

Warmer CCT Without Cyan content ← → Cooler Light With Cyan content

2700K – 5000K



> Control with Wavelinx, 2ch 0-10V, or DALI