

Project		Catalog #		Type	
Prepared by		Notes		Date	

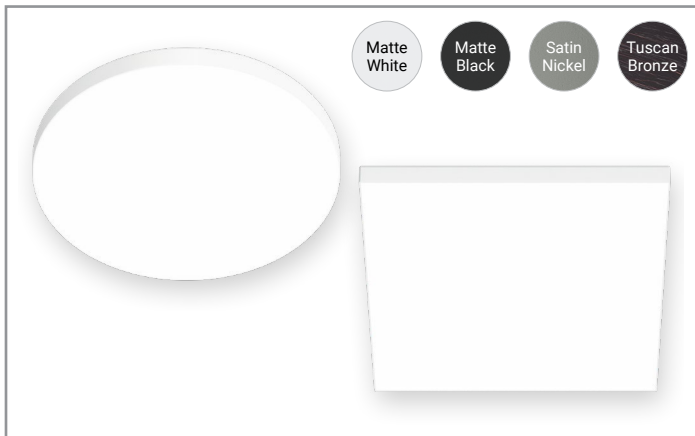

HALO

SMX6 Edgeless Surface Mount LED Downlight

The SMX series redefines the surface downlighting experience. With a fully luminous lens face, this series provides exceptional light quality with a sleek, edgeless design that blends effortlessly into any ceiling. The SMX fixtures are engineered to offer a versatile downlighting solution with selectable lumens and color temperatures including dim-to-warm in flicker-free phase cut or 0-10V dimming options. The innovative mounting method ensures a hassle-free installation that seats the fixture securely against the ceiling in either junction boxes or recessed housings. Upgrade your lighting experience with the SMX series and enjoy a seamless blend of style and functionality.

Typical Applications

Residential - Multifamily - Hospitality - Healthcare - Retail

Interactive Menu

- Order Information page 2
- Product Specifications page 4
- Energy Data page 5
- Photometric Data page 7
- Product Warranty

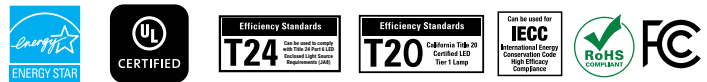

Refer to ENERGY STAR® Certified Products List.
Can be used to comply with California Title 24 High Efficacy requirements.
Certified to California Appliance Efficiency Database under JAB. 1



Top Product Features

- 6" Surface Mount Edgeless Design in Round or Square
- Fully luminous edge-to-edge lens with no front face flange
- **Field-SeleCCTable (90+ CRI):**
 - **Phase Cut Versions:** 6-Position Switch with 5 CCT (27/30/35/40/5000K) + Dim-to-Warm (3000K dims to 1800K)
 - **0-10V Versions:** 5 CCT (27/30/35/40/5000K)
- **Brightness:** Lumen Select 750/900/1200 lm (nominal)
- **Dimming:** Dims to less than 5% with compatible dimmers in either phase cut LE/TE (120V) or 0-10V (120-277V)
- Mounting hardware, orange LED Quick Connect and E26 adapter included
- Edgeless Decorative Overlays (sold separately)
- AIR-TITE, wet location-listed, IC-rated, and ENERGY STAR® certified
- 50,000 hrs of maintenance-free operation
- 5-year warranty

Dimensional and Mounting Details

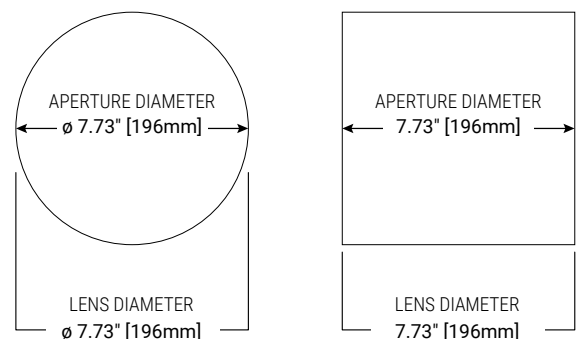
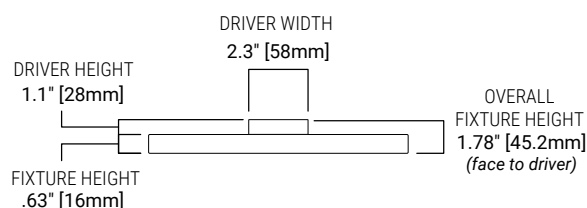

Order Information

Catalog Number	Description	Lumens (nominal)	CCT	Finish	Driver Compatibility	Packaging
SMX6RLSFS2W	6" Round Surface Mount LED Downlight	Lumen Selectable: 750/900/1200 lm	90+ CRI, Field Selectable CCT: Dim-to-Warm/2700/3000/3500/4000/5000K	Matte White	Phase Cut LE/TE 5%; 120V	Plastic-free recyclable
SMX6RLSFS010	6" Round Surface Mount LED Downlight	Lumen Selectable: 750/900/1200 lm	90+ CRI, Field Selectable CCT: 2700/3000/3500/4000/5000K	Matte White	0-10V 5%; 120-277V	Plastic-free recyclable
SMX6LSFS2W	6" Square Surface Mount LED Downlight	Lumen Selectable: 750/900/1200 lm	90+ CRI, Field Selectable CCT: Dim-to-Warm/2700/3000/3500/4000/5000K	Matte White	Phase Cut LE/TE 5%; 120V	Plastic-free recyclable
SMX6LSFS010	6" Square Surface Mount LED Downlight	Lumen Selectable: 750/900/1200 lm	90+ CRI, Field Selectable CCT: 2700/3000/3500/4000/5000K	Matte White	0-10V 5%; 120-277V	Plastic-free recyclable

Accessories – Decorative Trim Overlays (order separately)

Add a touch of style and personality to spaces with HALO Decorative Overlays by matching existing hardware or painted finishes.

Accessories		
Catalog Number	Description	Finish
SMX6RTRMMW	6" Round Decorative Overlay	Paintable Matte White
SMX6RTRMMB	6" Round Decorative Overlay	Matte Black
SMX6RTRMSN	6" Round Decorative Overlay	Satin Nickel
SMX6RTRMTBZ	6" Round Decorative Overlay	Tuscan Bronze
SMX6STRMMW	6" Square Decorative Overlay	Paintable Matte White
SMX6STRMMB	6" Square Decorative Overlay	Matte Black
SMX6STRMSN	6" Square Decorative Overlay	Satin Nickel
SMX6STRMTBZ	6" Square Decorative Overlay	Tuscan Bronze



SMX6RTRMMW
Paintable Matte White



SMX6RTRMMB
Matte Black



SMX6RTRMSN
Satin Nickel



SMX6RTRMTBZ
Tuscan Bronze



SMX6STRMMW
Paintable Matte White



SMX6STRMMB
Matte Black



SMX6STRMSN
Satin Nickel



SMX6STRMTBZ
Tuscan Bronze

Accessories – 3D Printed Decorative Trim Shades (order separately)

Snap-on 3D printed shades designed to fit HALO SMX Surface Mount downlights, adding depth, texture, and a more architectural look. Easily upgrade the fixture's appearance with distinctive forms that bring a custom, design-forward feel to any space.

Accessories				
Catalog Number	Description	Finish	Diameter	Height
SMX610	6" SMX 3DP Trim Mini Drop	Clear	7.73"	1.86"
SMX620	6" SMX 3DP Trim Drop	Clear	7.73"	2.84"
SMX630	6" SMX 3DP Trim Tulip	Clear	7.73"	3.49"
SMX640	6" SMX 3DP Trim Bowl	Clear	7.73"	2.92"



SMX610
Mini Drop



SMX620
Drop



SMX630
Tulip



SMX640
Bowl

Accessories – Emergency Power (order separately)

Emergency power to connected fixtures during outages. Automatically switches on and dims fixtures for extended runtime.

Emergency Power Accessories	
Catalog Number	Description
INVM-10W-AD	Single Phase 0-10V Auto Dimming (can power up to 3 SMX6" fixtures)



SMX6RLSFSD2W



SMX6RLSFS010



SMX6SLSFSD2W



SMX6SLSFS010

Compatible Junction Boxes³



**Octagon
Steel Light Fixture w/Fan Box**
4" x 4" x 2-1/8"



**Round
New Work Fixture Box (Plastic)**
4" Diameter x 2-3/16"



**Round
New Work Ceiling Box (Plastic)**
3-1/2" Diameter x 2-3/4"



**Round
Old Work Box (Plastic)**
4-1/4" Diameter flange (3-1/2" I.D.) x 2-5/8"



**Round
New Work Fixture Box (Plastic) w/Bar Hanger**
4" x 2-3/16"



**TP316
For non-metallic cable**
4" x 4" x 2-1/8"



**TP317
For metal clad cable**
4" x 4" x 2-1/8"



**JB4FR2
4" NC JBox for Fire Rated Ceilings**
4" diameter x 5-1/2"
(102mm x 140mm)

³. This is a representative list of compatible junction boxes only. Information contained in this literature about other manufacturers' products is from published information made available by the manufacturer and is deemed to be reliable, but has not been verified. Cooper Lighting Solutions makes no specific recommendation on product selection and there are no warranties of performance or compatibility implied. Installer must determine that site conditions are suitable to allow proper installation of the mounting bracket in the box.

Compatible Housings

HALO - 5" Housings⁴

HALO LED Housings	H550ICAT, H550RICAT, H2550ICAT
Standard Housings	H5ICAT, H5ICATNB, H5RICAT
Shallow Housings	H25ICAT, H25RICAT, H25ICATNB, H2550ICAT
Fire Rated Housings	H550FR2ICAT

4. This fixture is UL Certified for use with any 5" diameter recessed housing constructed of steel or aluminum with an internal volume that exceeds 107.9" in³ addition to those noted below and does not exceed the input rating of the housing.

HALO - 6" Housings⁵

HALO LED	H750ICAT, H750RICAT, H750TCP, H2750ICAT, H2750RICAT
Standard Housing	H7ICAT, H7ICT, H7ICATNB, H7RICAT, H7ICATNB
Shallow Housing	H27ICAT, H27RICAT, H2750ICAT
Fire Rated Housing	H750FR2ICAT

5. The fixture is UL Certified for use with any 6" diameter recessed luminaire constructed of steel or aluminum with an internal volume that exceeds 97.4 in³ addition to those noted below and does not exceed the input rating of the luminaire.

Product Specifications

Module

- The LED surface mount downlight consists of an LED array, optical assembly, driver, and edgeless trim
- Achieves L70 at 50,000 hrs in IC (insulation contact) and non-IC applications

Selectable System

- Use the CCT select switch to choose between Dim-to-Warm (D2W), 2700K, 3000K, 3500K, 4000K, and 5000K CCT
 - Note:** D2W only available for phase cut fixtures
- Dim-to-Warm option starts at 3000K and warms to 1800K as the fixture dims
- Factory default is set to 3000K
- Use the 3-position Lumen Select switch to choose the brightness level (Low, Medium, High)
- Lumen Select factory default is to the highest lumen option

LED Array

- Mid-power LED array provides a uniform light source with high efficiency and no pixilation
- 90+ CRI minimum, R9 greater than 50
- Color accuracy at 3 SDCM at the endpoints and 4 SDCM in the middle provide color consistency and uniformity

Driver

- Integral 120V 60Hz constant current driver provides noise-free, high-efficiency operation
- Phase Cut Dimming: Continuous, flicker-free dimming from 100% to 5% with compatible leading or trailing edge (LE/TE) phase cut dimmers. (See Dimming Guide for compatible dimmers.)
- 0-10V Dimming: Continuous, flicker-free dimming from 100% to 5% with compatible 0-10V dimmers. (See Dimming Guide for compatible dimmers.)
 - Tip:** For optimal dimming performance, consider dimmers with low-end trim adjustment; Note that some dimmers require a neutral wire in the box.
- Wiring:** Includes optional inline electrical orange LED Quick Connect and E26 medium socket adapter to provide mains connection

Electrical Junction Box Mounting

- Twist and lock steel mounting bracket to fit snugly to the ceiling
- Installs from below the ceiling in most 30 (3-1/2") and 40 (4") standard round/octagonal junction boxes along with compact (pancake) junction boxes

- Mounting bracket covers selectable switches
- May be used in compatible electrical junction boxes in direct contact with insulation, including spray foam insulation
- Installer must ensure compatibility of fit, wiring, and proper mounting in the electrical junction box. This includes all applicable national and local electrical along with building coded NEMA LSD 57-2013.
- Reference installation instructions for complete mounting steps
- Compatible with JB4FR2 for up to 2 hour fire safe protection.
 - JB4FR2 Meets UL514A Metallic Outlet Box and is suitable for use in fire-rated ceiling construction that requires up to 2-hour protection per International Building Code Section 714

Recessed Housing Mounting

Non-California versions only

- Optional steel torsion springs or friction blades to hold the module securely in a recessed housing
 - Installs from below the ceiling to HALO 5" and 6" recessed housings with included torsion springs
- The included wire nuts, LED connector, and E26 medium socket adapter allow for easy mounting to recessed housings
- Reference installation instructions for complete mounting steps
- May be installed in IC-rated recessed housings that are in direct contact with insulation

NOTE: Not for use in recessed housings in direct contact with spray foam insulation. Refer to NEMA LSD 57-2013

Gasket

- Closed-cell gasket achieves restrictive airflow requirements without additional caulking

Decorative Overlays (sold separately)

- Overlays cover the edge of the fixture while maintaining the edgeless design and are sold as an accessory for a designer finish
 - Paintable Matte White
 - Satin Nickel
 - Matte Black
 - Tuscan Bronze

Emergency Mini Inverter

- Provides 90 minutes of 10VA emergency power to lighting fixtures
- 0-10V Auto dimming allows up to 50VA max dimmable load
- 10VA max non-dimmable load
- Automatic 120VAC or 277VAC output power to driver or ballast means easy field install
- UL924 and CSA 22.2 No.141 listed for field or factory installation
- Remote mounting up to 250feet
- Maintenance free lithium-ion battery
- See Mini Inverter Spec Sheet for more information

Compliance

- cULus certified for US and Canada
- Wet Location listed for showers and covered outdoor ceilings
- Airtight per ASTM-E283 (no gasket necessary)
- Suitable for use in clothes closets when installed in accordance with the NEC 410.16 spacing requirements
- EMI/RFI emissions per FCC 47CFR Part 15 consumer limits
- Contains no mercury or lead and RoHS compliant¹
- Photometric testing in accordance with IES LM-79-08
- Lumen maintenance projections in accordance with IES LM-80-08 and TM-21-11
- ENERGY STAR® certified, reference Certified Light Fixtures database
- Certified to State of California Title 20, State regulated LED Lamp; reference Modernized Appliance Efficiency Database System (MAEDBS) for State-regulated LED Lamp
- Can be used for State of California Title 24 high efficacy LED compliance under JA8¹, reference Modernized Appliance Efficiency Database System (MAEDBS) for 2022 JA8 High Efficacy Lighting

Warranty

- Five year limited warranty, consult website for details. www.cooperlighting.com/warranty

Energy Data

	120V (Triac)		120V-277V (0-10V)			
	Round	Square	Round		Square	
	SMX6RLSFS2W	SMX6SLSFS2W	SMX6RLSFS010		SMX6SLSFS010	
Lumens	750	750	750	750	750	750
Input Voltage (V)	120V	120V	120V	277V	120V	277V
Input Current (A)	67mA	67mA	62mA	33mA	62mA	33mA
Input Power (W)	7.89W	7.89W	7.6W	8.5W	7.61W	8.51W
Efficiency	80.66%	80.66%	79.45%	74.52%	79.35%	74.88%
Inrush (A)	2.86A @ 44usec	2.86A @ 44usec	1.22A @ 116usec	2.6 @ 124usec	1.22A @ 116usec	2.6 @ 124usec
THDi (%)	16.3%	16.3%	6.63%	18.6%	6.63%	18.61%
PF	0.959	0.959	0.995	0.927	0.995	0.928
T Ambient	-30 to +40 °C	-30 to +40 °C	-30 to +40 °C	-30 to +40 °C	-30 to +40 °C	-30 to +40 °C
Sound Rating	19.71dB @1feet	19.71dB @1feet	19.29dB @1feet	19.29dB @1feet	19.29dB @1feet	19.29dB @1feet
Efficacy(LPW)	95LPW	95LPW	99LPW	88LPW	99LPW	88LPW
Lumens	900	900	900	900	900	900
Input Voltage (V)	120V	120V	120V	277V	120V	277V
Input Current (A)	81mA	81mA	86mA	42mA	85mA	43mA
Input Power (W)	9.46W	9.46W	10.33W	11.18W	10.32W	11.09W
Efficiency	81.01%	81.01%	81.16%	77.36%	81.94%	78.61%
Inrush (A)	2.86A @ 44usec	2.86A @ 44usec	1.22A @ 116usec	2.6 @ 124usec	1.22A @ 116usec	2.6 @ 124usec
THDi (%)	14.1%	14.1%	7.3%	13%	7.31%	13.1%
PF	0.971	0.971	0.995	0.958	0.996	0.959
T Ambient	-30 to +40 °C	-30 to +40 °C	-30 to +40 °C	-30 to +40 °C	-30 to +40 °C	-30 to +40 °C
Sound Rating	19.71dB @1feet	19.71dB @1feet	19.29dB @1feet	19.29dB @1feet	19.29dB @1feet	19.29dB @1feet
Efficacy(LPW)	95LPW	95LPW	87LPW	81LPW	87LPW	81LPW
Lumens	1200	1200	1200	1200	1200	1200
Input Voltage (V)	120V	120V	120V	277V	120V	277V
Input Current (A)	116mA	116mA	107mA	50mA	107mA	50mA
Input Power (W)	13.8W	13.8W	12.73W	13.44W	12.98W	13.8W
Efficiency	82.12%	82.12%	81.47%	78.9%	82.35%	78.43%
Inrush (A)	2.86A @ 44usec	2.86A @ 44usec	1.22A @ 116usec	2.6 @ 124usec	1.22A @ 116usec	2.6 @ 124usec
THDi (%)	11.6%	11.6%	11.72%	11.47%	12.11%	11.62%
PF	0.982	0.982	0.991	0.972	0.991	0.973
T Ambient	-30 to +40 °C	-30 to +40 °C	-30 to +40 °C	-30 to +40 °C	-30 to +40 °C	-30 to +40 °C
Sound Rating	19.71dB @1feet	19.71dB @1feet	19.29dB @1feet	19.29dB @1feet	19.29dB @1feet	19.29dB @1feet
Efficacy(LPW)	87LPW	87LPW	94LPW	89LPW	93LPW	87LPW

SMX6RLSFS2W (Equivalent to 100W Incandescent)				
CCT	Watts	Lumens	LPW	CRI
2700K	13.9	1385	99.7	93
3000K	14.0	1405	100.4	93
3500K	14.1	1420	100.7	93
4000K	14.0	1430	102.1	93
5000K	13.9	1450	104.3	93

SMX6RLSFS010 (Equivalent to 100W Incandescent)				
CCT	Watts	Lumens	LPW	CRI
2700K	12.5	1265	101.1	93
3000K	12.4	1265	102	93
3500K	12.4	1270	102.4	93
4000K	12.4	1280	103.2	93
5000K	12.3	1310	106.5	93

SMX6SLSFS2W (Equivalent to 100W Incandescent)				
CCT	Watts	Lumens	LPW	CRI
2700K	13.8	1395	100.9	93
3000K	13.6	1360	100	93
3500K	13.6	1390	102.2	93
4000K	13.6	1390	102.2	93
5000K	13.5	1390	103	93

SMX6SLSFS010 (Equivalent to 100W Incandescent)				
CCT	Watts	Lumens	LPW	CRI
2700K	12.4	1255	101	93
3000K	12.4	1215	98	93
3500K	12.4	1210	97.6	93
4000K	12.4	1220	98.4	93
5000K	12.3	1230	100	93

Photometric Data

[View IES files](#)

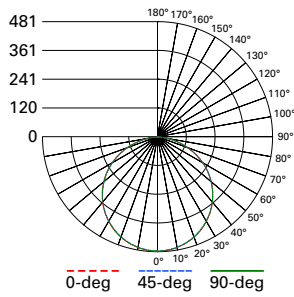

SMX6RLSFSD2W-1200LM-3000K

Spacing criterion:
 (0-180) 1.27 | (90-270) 1.27 |
 (Diagonal) 1.39
 Beam Angle: 115°
 Field Angle: 163°
 Lumens: 1405
 Input Watts: 14 W
 Efficacy: 100.4 LPW
 UGR: 22
 Test Report: P938627

Zonal Lumen	Lumens	% Lumens
0-30	374	26.6
0-40	615	43.8
0-60	1099	78.2
0-90	1405	100

CCT: Range of 2700K - 5000K

 Dim-to-Warm: Range of 1800K - 3000K

TM-30-15	Rf = 93
	Rg = 101
CRI/CIE	Ra = 97
	R9 = 79.8

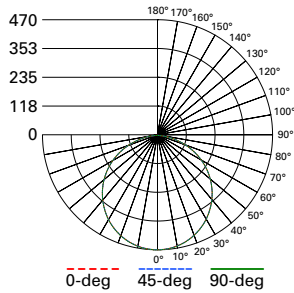

SMX6LSFSD2W-1200LM-3000K

Spacing criterion:
 (0-180) 1.26 | (90-270) 1.27 |
 (Diagonal) 1.38
 Beam Angle: 114°
 Field Angle: 162°
 Lumens: 1358
 Input Watts: 13.6 W
 Efficacy: 99.9 LPW
 UGR: 21
 Test Report: P997212

Zonal Lumen	Lumens	% Lumens
0-30	365	26.9
0-40	600	44.2
0-60	1068	78.6
0-90	1358	100

CCT: Range of 2700K - 5000K

 Dim-to-Warm: Range of 1800K - 3000K

TM-30-15	Rf = 93
	Rg = 101
CRI/CIE	Ra = 97
	R9 = 79.8

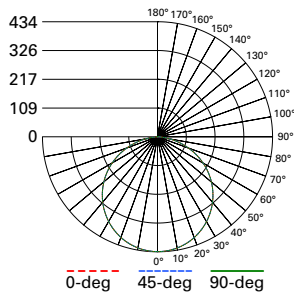

SMX6RLSFS010-1200LM-3000K

Spacing criterion:
 (0-180) 1.27 | (90-270) 1.27 |
 (Diagonal) 1.39
 Beam Angle: 114°
 Field Angle: 162°
 Lumens: 1262
 Input Watts: 12.4 W
 Efficacy: 101.8 LPW
 UGR: 21
 Test Report: P997182

Zonal Lumen	Lumens	% Lumens
0-30	338	26.8
0-40	555	44
0-60	990	78.5
0-90	1262	100

CCT: Range of 2700K - 5000K

TM-30-15	Rf = 93
	Rg = 101
CRI/CIE	Ra = 97
	R9 = 79.8

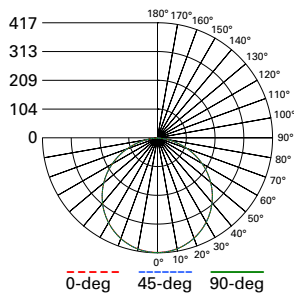

SMX6LSFS010-1200LM-3000K

Spacing criterion:
 (0-180) 1.27 | (90-270) 1.27 |
 (Diagonal) 1.39
 Beam Angle: 114°
 Field Angle: 163°
 Lumens: 1213
 Input Watts: 12.4 W
 Efficacy: 97.8 LPW
 UGR: 21
 Test Report: P997197

Zonal Lumen	Lumens	% Lumens
0-30	325	26.8
0-40	533	44
0-60	951	78.4
0-90	1213	100

CCT: Range of 2700K - 5000K

TM-30-15	Rf = 93
	Rg = 101
CRI/CIE	Ra = 97
	R9 = 79.8



Mini Inverter Schematic

