

Project		Catalog #		Type	
Prepared by		Notes		Date	

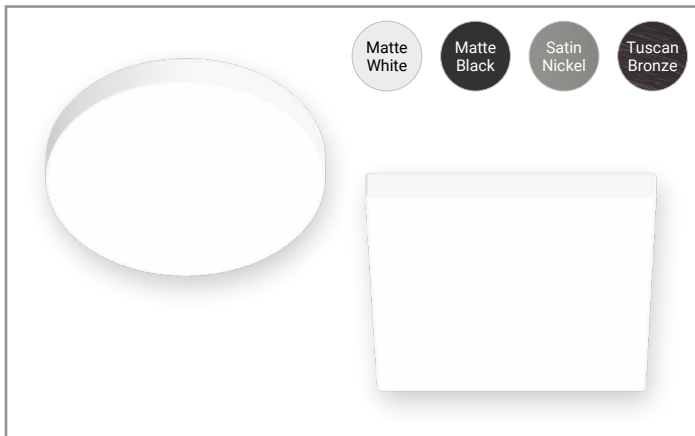

# HALO

## SMX4 Edgeless Surface Mount LED Downlight

The SMX series redefines the surface downlighting experience. With a fully luminous lens face, this series provides exceptional light quality with a sleek, edgeless design that blends effortlessly into any ceiling. The SMX fixtures are engineered to offer a versatile downlighting solution with selectable lumens and color temperatures including dim-to-warm in flicker-free phase cut or 0-10V dimming options. The innovative mounting method ensures a hassle-free installation that seats the fixture securely against the ceiling in either junction boxes or recessed housings. Upgrade your lighting experience with the SMX series and enjoy a seamless blend of style and functionality.

### Typical Applications

Residential - Multifamily - Hospitality - Healthcare - Retail

### Interactive Menu

- Order Information [page 2](#)
- Product Specifications [page 4](#)
- Energy Data [page 5](#)
- Photometric Data [page 6](#)
- Product Warranty

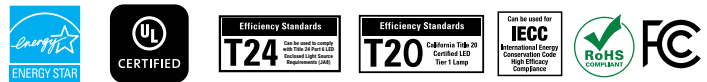

Refer to ENERGY STAR® Certified Products List.  
Can be used to comply with California Title 24 High Efficacy requirements.  
Certified to California Appliance Efficiency Database under JAB. <sup>1</sup>



### Top Product Features

- 4" Surface Mount Edgeless Design in Round or Square
- Fully luminous edge-to-edge lens with no front face flange
- **Field-SeleCCTable (90+ CRI):**
  - **Phase Cut Versions:** 6-Position Switch with 5 CCT (27/30/35/40/5000K) + Dim-to-Warm (3000K dims to 1800K)
  - **0-10V Versions:** 5 CCT (27/30/35/40/5000K)
- **Brightness:** Lumen Select 650/800/1000 lm (nominal)
- **Dimming:** Dims to less than 5% with compatible dimmers in either phase cut LE/TE (120V) or 0-10V (120-277V)
- Mounting hardware, orange LED Quick Connect and E26 adapter included
- Edgeless Decorative Overlays (sold separately)
- AIR-TITE, wet location-listed, IC-rated, and ENERGY STAR® certified
- 50,000 hrs of maintenance-free operation
- 5-year warranty

### Dimensional and Mounting Details

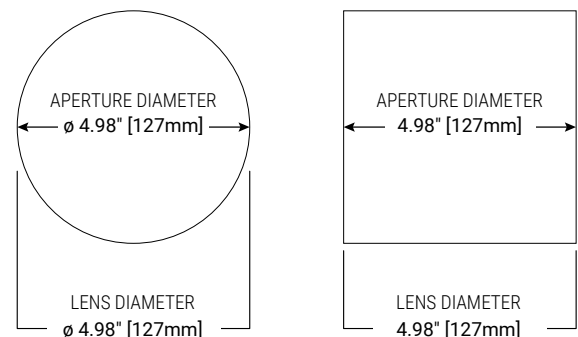
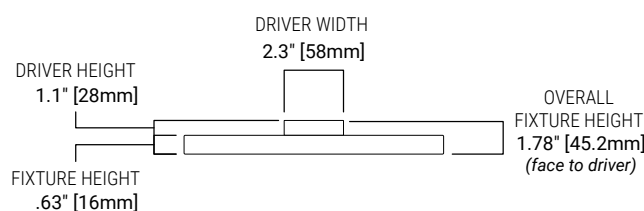

## Order Information

Catalog Number	Description	Lumens (nominal)	CCT	Finish	Driver Compatibility	Packaging
SMX4RLSFSD2W	4" Round Surface Mount LED Downlight	Lumen Selectable: 650/800/1000 lm	90+ CRI, Field Selectable CCT: Dim-to-Warm/2700/3000/3500/4000/5000K	Matte White	Phase Cut LE/TE 5%; 120V	Plastic-free recyclable
SMX4RLSFS010	4" Round Surface Mount LED Downlight	Lumen Selectable: 650/800/1000 lm	90+ CRI, Field Selectable CCT: 2700/3000/3500/4000/5000K	Matte White	0-10V 5%; 120-277V	Plastic-free recyclable
SMX4SLSFSD2W	4" Square Surface Mount LED Downlight	Lumen Selectable: 650/800/1000 lm	90+ CRI, Field Selectable CCT: Dim-to-Warm/2700/3000/3500/4000/5000K	Matte White	Phase Cut LE/TE 5%; 120V	Plastic-free recyclable
SMX4SLSFS010	4" Square Surface Mount LED Downlight	Lumen Selectable: 650/800/1000 lm	90+ CRI, Field Selectable CCT: 2700/3000/3500/4000/5000K	Matte White	0-10V 5%; 120-277V	Plastic-free recyclable

### Accessories – Decorative Trim Overlays (order separately)

Add a touch of style and personality to spaces with HALO Decorative Overlays by matching existing hardware or painted finishes.

Accessories		
Catalog Number	Description	Finish
SMX4RTRMMW	4" Round Decorative Overlay	Paintable Matte White
SMX4RTRMMB	4" Round Decorative Overlay	Matte Black
SMX4RTRMSN	4" Round Decorative Overlay	Satin Nickel
SMX4RTRMTBZ	4" Round Decorative Overlay	Tuscan Bronze
SMX4STRMMW	4" Square Decorative Overlay	Paintable Matte White
SMX4STRMMB	4" Square Decorative Overlay	Matte Black
SMX4STRMSN	4" Square Decorative Overlay	Satin Nickel
SMX4STRMTBZ	4" Square Decorative Overlay	Tuscan Bronze



### Accessories – 3D Printed Decorative Trim Shades (order separately)

Snap-on 3D printed shades designed to fit HALO SMX Surface Mount downlights, adding depth, texture, and a more architectural look. Easily upgrade the fixture's appearance with distinctive forms that bring a custom, design-forward feel to any space.

Accessories				
Catalog Number	Description	Finish	Diameter	Height
SMX410	4" SMX 3DP Trim Mini Drop	Clear	4.98"	1.86"
SMX420	4" SMX 3DP Trim Drop	Clear	4.98"	2.84"
SMX430	4" SMX 3DP Trim Tulip	Clear	4.98"	3.49"
SMX440	4" SMX 3DP Trim Bowl	Clear	4.98"	2.92"



### Accessories – Emergency Power (order separately)

Emergency power to connected fixtures during outages. Automatically switches on and dims fixtures for extended runtime.

Emergency Power Accessories	
Catalog Number	Description
INVM-10W-AD	Single Phase 0-10V Auto Dimming (can power up to 4 SMX4" fixtures)

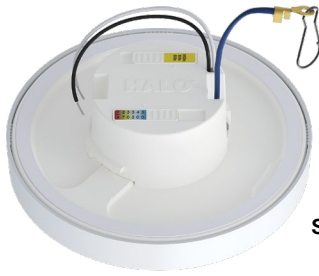

**SMX4RLSFSD2W**

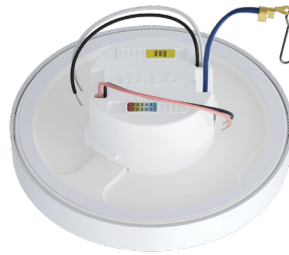

**SMX4RLSFS010**



**SMX4SLSFSD2W**



**SMX4SLSFS010**

## Compatible Junction Boxes<sup>3</sup>



**Octagon  
Steel Light Fixture w/Fan Box**  
4" x 4" x 2-1/8"



**Round  
New Work Fixture Box (Plastic)**  
4" Diameter x 2-3/16"



**Round  
New Work Ceiling Box (Plastic)**  
3-1/2" Diameter x 2-3/4"



**Round  
Old Work Box (Plastic)**  
4-1/4" Diameter flange (3-1/2" I.D.) x 2-5/8"



**Round  
New Work Fixture Box (Plastic) w/Bar Hanger**  
4" x 2-3/16"



**TP316  
For non-metallic cable**  
4" x 4" x 2-1/8"



**TP317  
For metal clad cable**  
4" x 4" x 2-1/8"

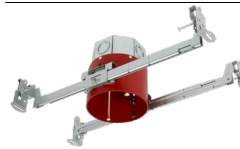

**JB4FR2  
4" NC JBox for Fire Rated Ceilings**  
4" diameter x 5-1/2"  
(102mm x 140mm)

3. This is a representative list of compatible junction boxes only. Information contained in this literature about other manufacturers' products is from published information made available by the manufacturer and is deemed to be reliable, but has not been verified. Cooper Lighting Solutions makes no specific recommendation on product selection and there are no warranties of performance or compatibility implied. Installer must determine that site conditions are suitable to allow proper installation of the mounting bracket in the box.

## Compatible Housings

### HALO - 4" Housings<sup>4</sup>

Standard Housing	H99ICAT, H99RTAT, H99TAT
LED Housing	H995ICAT, H995RICAT, H245RICAT, H245ICAT
Shallow Housing	H245ICAT, H245RICAT

4. The SMX4 is UL Certified for use with any 4" diameter recessed housing constructed of steel or aluminum with an internal volume that exceeds 62.3 in<sup>3</sup> addition to those noted above.

## Product Specifications

### Module

- The LED surface mount downlight consists of an LED array, optical assembly, driver, and edgeless trim
- Achieves L70 at 50,000 hrs in IC (insulation contact) and non-IC applications

### Selectable System

- Use the CCT select switch to choose between Dim-to-Warm (D2W), 2700K, 3000K, 3500K, 4000K, and 5000K CCT
  - Note:** D2W only available for phase cut fixtures
- Dim-to-Warm option starts at 3000K and warms to 1800K as the fixture dims
- Factory default is set to 3000K
- Use the 3-position Lumen Select switch to choose the brightness level (Low, Medium, High)
- Lumen Select factory default is to the highest lumen option

### LED Array

- Mid-power LED array provides a uniform light source with high efficiency and no pixilation
- 90+ CRI minimum, R9 greater than 50
- Color accuracy at 3 SDCM at the endpoints and 4 SDCM in the middle provide color consistency and uniformity

### Driver

- Integral 120V 60Hz constant current driver provides noise-free, high-efficiency operation
- Phase Cut Dimming: Continuous, flicker-free dimming from 100% to 5% with compatible leading or trailing edge (LE/TE) phase cut dimmers. (See Dimming Guide for compatible dimmers.)
- 0-10V Dimming: Continuous, flicker-free dimming from 100% to 5% with compatible 0-10V dimmers. (See Dimming Guide for compatible dimmers.)
  - Tip:** For optimal dimming performance, consider dimmers with low-end trim adjustment; Note that some dimmers require a neutral wire in the box.
- Wiring:** Includes optional inline electrical orange LED Quick Connect and E26 medium socket adapter to provide mains connection

### Electrical Junction Box Mounting

- Twist and lock steel mounting bracket to fit snugly to the ceiling
- Installs from below the ceiling in most 30 (3-1/2") and 40 (4") standard round/octagonal junction boxes along with compact (pancake) junction boxes

- Mounting bracket covers selectable switches
- May be used in compatible electrical junction boxes in direct contact with insulation, including spray foam insulation
- Installer must ensure compatibility of fit, wiring, and proper mounting in the electrical junction box. This includes all applicable national and local electrical along with building coded NEMA LSD 57-2013.
- Reference installation instructions for complete mounting steps
- Compatible with JB4FR2 for up to 2 hour fire safe protection.
  - JB4FR2 Meets UL514A Metallic Outlet Box and is suitable for use in fire-rated ceiling construction that requires up to 2-hour protection per International Building Code Section 714

### Recessed Housing Mounting

#### Non-California versions only

- Optional steel torsion springs or friction blades to hold the module securely in a recessed housing
  - Installs from below the ceiling to HALO 4" recessed housings with included friction blades
- The included wire nuts, LED connector, and E26 medium socket adapter allow for easy mounting to recessed housings
- Reference installation instructions for complete mounting steps
- May be installed in IC-rated recessed housings that are in direct contact with insulation

**NOTE:** Not for use in recessed housings in direct contact with spray foam insulation. Refer to NEMA LSD 57-2013

### Gasket

- Closed-cell gasket achieves restrictive airflow requirements without additional caulking

### Decorative Overlays (sold separately)

- Overlays cover the edge of the fixture while maintaining the edgeless design and are sold as an accessory for a designer finish
  - Paintable Matte White
  - Satin Nickel
  - Matte Black
  - Tuscan Bronze

### Emergency Mini Inverter

- Provides 90 minutes of 10VA emergency power to lighting fixtures
- 0-10V Auto dimming allows up to 50VA max dimmable load
- 10VA max non-dimmable load
- Automatic 120VAC or 277VAC output power to driver or ballast means easy field install
- UL924 and CSA 22.2 No.141 listed for field or factory installation
- Remote mounting up to 250feet
- Maintenance free lithium-ion battery
- See Mini Inverter Spec Sheet for more information

### Compliance

- cULus certified for US and Canada
- Wet Location listed for showers and covered outdoor ceilings
- Airtight per ASTM-E283 (no gasket necessary)
- Suitable for use in clothes closets when installed in accordance with the NEC 410.16 spacing requirements
- EMI/RFI emissions per FCC 47CFR Part 15 consumer limits
- Contains no mercury or lead and RoHS compliant<sup>1</sup>
- Photometric testing in accordance with IES LM-79-08
- Lumen maintenance projections in accordance with IES LM-80-08 and TM-21-11
- ENERGY STAR® certified, reference Certified Light Fixtures database
- Certified to State of California Title 20, State regulated LED Lamp; reference Modernized Appliance Efficiency Database System (MAEDBS) for State-regulated LED Lamp
- Can be used for State of California Title 24 high efficacy LED compliance under JA8<sup>1</sup>, reference Modernized Appliance Efficiency Database System (MAEDBS) for 2022 JA8 High Efficacy Lighting

### Warranty

- Five year limited warranty, consult website for details. [www.cooperlighting.com/warranty](http://www.cooperlighting.com/warranty)

## Energy Data

	120V (Triac)		120V-277V (0-10V)			
	Round	Square	Round		Square	
	SMX4RLSFS2W	SMX4SLSFS2W	SMX4RLSFS010		SMX4SLSFS010	
Lumens	650	650	650	650	650	650
Input Voltage (V)	120V	120V	120V	277V	120V	277V
Input Current (A)	62mA	62mA	58mA	27mA	57mA	28mA
Input Power (W)	7W	7W	6.94W	7W	6.94W	7W
Efficiency	78.91%	78.91%	81.11%	78.98%	81.11%	78.98%
Inrush (A)	1.25A @ 16usec	1.25A @ 16usec	2.2A @ 42usec	2.78 @ 62usec	2.2A @ 42usec	2.78 @ 62usec
THDi (%)	16.5%	16.5%	9.9%	19.3%	9.9%	19.3%
PF	0.946	0.946	0.991	0.928	0.991	0.928
T Ambient	-30 to +40 °C	-30 to +40 °C	-30 to +40 °C	-30 to +40 °C	-30 to +40 °C	-30 to +40 °C
Sound Rating	20.6dB @1feet	20.6dB @1feet	18.91dB @1feet	18.91dB @1feet	20.6dB @1feet	20.6dB @1feet
Efficacy(LPW)	93LPW	93LPW	94LPW	93LPW	94LPW	93LPW
Lumens	800	800	800	800	800	800
Input Voltage (V)	120V	120V	120V	277V	120V	277V
Input Current (A)	76mA	76mA	78mA	35mA	79mA	34mA
Input Power (W)	8.7W	8.7W	9.35W	9.23W	9.35W	9.23W
Efficiency	80.64%	80.64%	80.71%	80.31%	80.71%	80.31%
Inrush (A)	1.25A @ 16usec	1.25A @ 16usec	2.2A @ 42usec	2.78 @ 62usec	2.2A @ 42usec	2.78 @ 62usec
THDi (%)	14.5%	14.5%	10.5%	15.4%	10.5%	15.4%
PF	0.96	0.96	0.99	0.957	0.99	0.957
T Ambient	-30 to +40 °C	-30 to +40 °C	-30 to +40 °C	-30 to +40 °C	-30 to +40 °C	-30 to +40 °C
Sound Rating	20.6dB @1feet	20.6dB @1feet	18.91dB @1feet	18.91dB @1feet	20.6dB @1feet	20.6dB @1feet
Efficacy(LPW)	92LPW	92LPW	86LPW	87LPW	86LPW	87LPW
Lumens	1000	1000	1000	1000	1000	1000
Input Voltage (V)	120V	120V	120V	277V	120V	277V
Input Current (A)	98mA	98mA	96mA	42mA	96mA	42mA
Input Power (W)	11.4W	11.4W	11.45W	11.22W	11.45W	11.22W
Efficiency	80.59%	80.59%	80.17%	80.91%	80.17%	80.91%
Inrush (A)	1.25A @ 16usec	1.25A @ 16usec	2.2A @ 42usec	2.78 @ 62usec	2.2A @ 42usec	2.78 @ 62usec
THDi (%)	12.3%	12.3%	9.9%/10.5%/11.3%	16.8%	11.3%	16.8%
PF	0.974	0.974	0.987	0.965	0.987	0.965
T Ambient	-30 to +40 °C	-30 to +40 °C	-30 to +40 °C	-30 to +40 °C	-30 to +40 °C	-30 to +40 °C
Sound Rating	20.6dB @1feet	20.6dB @1feet	18.91dB @1feet	18.91dB @1feet	20.6dB @1feet	20.6dB @1feet
Efficacy(LPW)	88LPW	88LPW	87LPW	89LPW	87LPW	89LPW

SMX4RLSFS2W (Equivalent to 75W Incandescent)				
CCT	Watts	Lumens	LPW	CRI
2700K	11.5	1150	99.9	92
3000K	11.5	1135	98.7	93
3500K	11.5	1130	98.3	93
4000K	11.5	1130	98.3	93
5000K	11.5	1130	98.3	93

SMX4RLSFS010 (Equivalent to 75W Incandescent)				
CCT	Watts	Lumens	LPW	CRI
2700K	10.9	1050	96.3	92
3000K	10.9	1015	93.1	93
3500K	10.8	1020	94.4	93
4000K	10.8	1030	95.4	93
5000K	10.8	1060	98.1	93

SMX4SLSFS2W (Equivalent to 75W Incandescent)				
CCT	Watts	Lumens	LPW	CRI
2700K	11.5	1145	99.7	92
3000K	11.5	1135	98.7	93
3500K	11.5	1110	96.5	93
4000K	11.5	1110	96.5	93
5000K	11.5	1110	96.5	92

SMX4SLSFS010 (Equivalent to 75W Incandescent)				
CCT	Watts	Lumens	LPW	CRI
2700K	11.3	1010	89.2	92
3000K	11.3	1010	89.4	93
3500K	11.3	1030	91.2	93
4000K	11.3	1040	92	93
5000K	11.1	1060	95.5	91

## Photometric Data

 View IES files

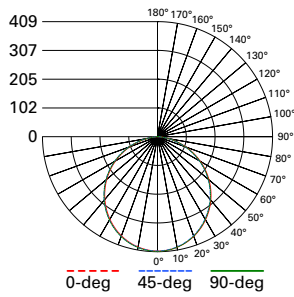

### SMX4RLSFSD2W-1000LM-3000K

Spacing criterion:  
 (0-180) 1.24 | (90-270) 1.24 |  
 (Diagonal) 1.36  
 Beam Angle: 110°  
 Field Angle: 160°  
 Lumens: 1135  
 Input Watts: 11.5 W  
 Efficacy: 98.7 LPW  
 UGR: 22  
 Test Report: P938612

Zonal Lumen	Lumens	% Lumens
0-30	315	27.7
0-40	514	45.2
0-60	904	79.6
0-90	1135	100

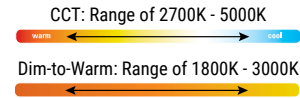

TM-30-15	Rf = 91
	Rg = 101
CRI/CIE	Ra = 94.8
	R9 = 69.7

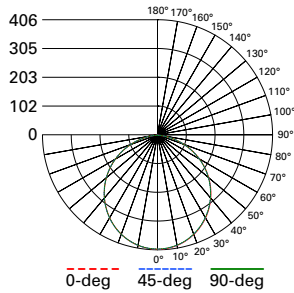

### SMX4SLSFSD2W-1000LM-3000K

Spacing criterion:  
 (0-180) 1.25 | (90-270) 1.25 |  
 (Diagonal) 1.37  
 Beam Angle: 111°  
 Field Angle: 160°  
 Lumens: 1134  
 Input Watts: 11.5 W  
 Efficacy: 98.6 LPW  
 UGR: 22  
 Test Report: P997167

Zonal Lumen	Lumens	% Lumens
0-30	314	27.7
0-40	513	45.2
0-60	904	79.7
0-90	1134	100

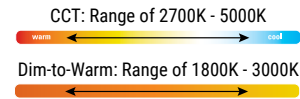

TM-30-15	Rf = 91
	Rg = 101
CRI/CIE	Ra = 94.8
	R9 = 69.7

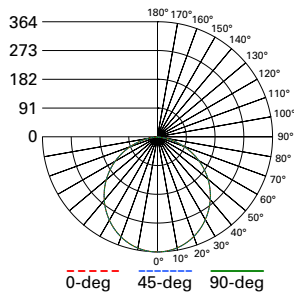

### SMX4RLSFS010-1000LM-3000K

Spacing criterion:  
 (0-180) 1.24 | (90-270) 1.24 |  
 (Diagonal) 1.36  
 Beam Angle: 111°  
 Field Angle: 160°  
 Lumens: 1014  
 Input Watts: 10.9 W  
 Efficacy: 93 LPW  
 UGR: 22  
 Test Report: P997137

Zonal Lumen	Lumens	% Lumens
0-30	281	27.7
0-40	459	45.3
0-60	807	79.6
0-90	1014	100

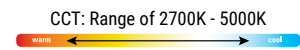

TM-30-15	Rf = 91
	Rg = 101
CRI/CIE	Ra = 94.8
	R9 = 69.7

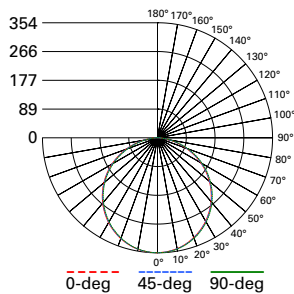

### SMX4SLSFS010-1000LM-3000K

Spacing criterion:  
 (0-180) 1.25 | (90-270) 1.26 |  
 (Diagonal) 1.37  
 Beam Angle: 113°  
 Field Angle: 162°  
 Lumens: 1009  
 Input Watts: 11.3 W  
 Efficacy: 89.3 LPW  
 UGR: 22  
 Test Report: P997152

Zonal Lumen	Lumens	% Lumens
0-30	274	27.2
0-40	449	44.5
0-60	796	78.9
0-90	1009	100

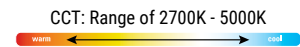

TM-30-15	Rf = 91
	Rg = 101
CRI/CIE	Ra = 94.8
	R9 = 69.7



## Mini Inverter Schematic

