

# Shaper

## DESCRIPTION

The Shaper 1400 is a series of small decorative pendants designed for use in architectural, hospitality, and commercial space applications. The Shaper 1400 series uses performance optics providing high lumen outputs with low surface glare. Available in one light level, four color temperatures, 80 or 90+ CRI, and one optic distribution. Ten standard RAL paint finishes are available and can be selected for the shade or trim, as well as two metal finishes. Mounting options include fourteen field cuttable decorative power cords, or rigid stem options. The Shaper 1400 decorative pendant is a fun comprehensive solution where aesthetics and performance are well balanced.

## SPECIFICATION FEATURES

### Construction

The decorative shroud and trim, covers electronic components and driver. Aluminum shroud is made of 0.63" thick aluminum grade 1100-0. The copper shade and trim is made of a C11000 060 copper alloy. The stem and canopy are 6061 grade aluminum.

### Weights:

1400 Rigid Stem Pendant	
Pendant + 36" rigid stem + canopy =	4lbs
Pendant + 48" rigid stem + canopy =	4lbs
Pendant + 96" rigid stem + canopy =	5lbs

  

1400 Decorative Cord Pendant	
Pendant + 120" of cord + canopy =	3lbs

### Electrical

Standard ELV driver is located in fixture head (120V only / 50-60Hz), and is suitable for ambient temperature of 25°C (77°F).

### Pendant Shade and Trim

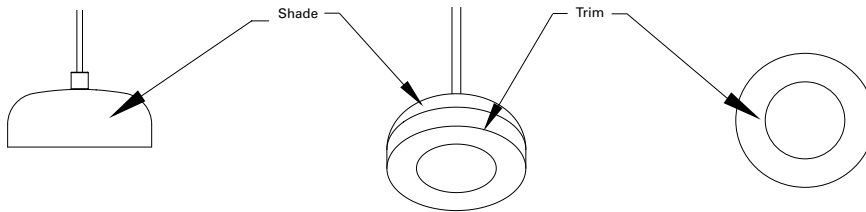

### LED Optics

Wavestream™ technology enables patented AccuAim™ optics for an enhanced distribution pattern. Available in 2700K, 3000K, 3500K, and 4000K color temperatures, and 80 or 90+ CRI. Lumen outputs range from 650 to 80 lumens dependent on color temperature.

### Mounting

Pendant head can be attached to a selection of decorative 3-wire power decorative cords, that can be cut in the field to allow for adjustment for variable heights (120" cord length ships standard). Or pendant head can be attached to a rigid pendant stem (36", 48", 96" standard lengths). The canopy mounting plate and cover, mounts to a standard 4-gang junction box. The rigid stem has a 20° swivel.

### Finish

Ten mix and match paint colors are

Catalog #		Type	
Project		Date	
Comments			
Prepared by			

available to choose from for the shade and the trim. They are standard RAL colors in a high gloss sheen. In addition, two metal finishes are also available in natural brushed aluminum or brushed copper, which are spun metal and have a protective clear coat.

### Compliance

Components are UL recognized and luminaires are cULus listed for 25°C (ambient environments). Dry Location Listed.

### Environment

Suited for 25° ambient. Dry location only.

### Control

Standard offering is an electronic low voltage, reverse phase dimmer.

### Life and Warranty

Standard five-year limited warranty on all parts.



**1400**  
LED

Pendant  
Direct

**CERTIFICATION DATA**  
UL/cUL Dry Location Listed  
LM79 / LM80 Compliant

**ENERGY DATA**  
>0.9 Power Factor  
<20% Total Harmonic Distortion  
120V 50/60 Hz  
25°C Ambient Temperature



For Adjustable Cord Complete Unit = Sample Catalog #: 1400-DOME-90-L40-120-SOC-TEB-CC-003 (two tone paint - shade and trim example)

For Rigid Stem Complete Unit = Sample Catalog #: 1400-DOME-80-L35-120-SCG-TCG-RS-RS-48-DOME-SL (monotone - shade and trim example)

### ORDERING INFORMATION:

Domestic Preferences <sup>1</sup>	Series	Family	CRI	Color Temperature <sup>2</sup> (Lumens, CRI, wattage)	Voltage	Shade Colors	Trim Colors	Mounting Options (select Color Power Cord or Rigid Stem)		
								Color Power Cord Options	Rigid Stem Option <sup>3</sup>	
[Blank] = Standard  TAA = Trade Agreements Act	1400	DOME	90 = 90 CRI	L27 = 720 lumens@80CRI or 650 lumens@90CRI at 2700K, 13W  L30 = 750 lumens@80CRI or 670 lumens@90CRI at 3000K, 13W  L35 = 780 lumens@80CRI or 690 lumens@90CRI at 3500K, 13W  L40 = 800 lumens@80CRI or 710 lumens@90CRI at 4000K, 13W	120 = 120V	SRR - Real Red SOC - OrangeCrush SYE - Yello? SAL - Avocado Lime SSS - Seafoam See STT - TotallyTurquoise SEB - Eaton Blue SBM - Black Metal SWL - White Light SCG - Charcoal Gray SCS - Copper Spun SBA - Brushed Aluminum SCC - Custom Color	TRR - Real Red TOC - Orange Crush TYE - Yello? TAL - Avocado Lime TSS - Seafoam See TTT - Totally Turquoise TEB - Eaton Blue TBM - Black Metal TWL - White Light TCG - Charcoal Gray TCS - Copper Spun TBA - Brushed Aluminum TCC - Custom Color	CC-119 - Pearl CC-001 - Black CC-029 - Gunmetal Silver CC-620 - Red CC-810 - Orange CC-710 - Yellow Gold CC-320 - Lime Green CC-401 - Cobalt Blue CC-510 - Purple CC-031 - Gray Tweed CC-540 - Magenta CC-002 - Black and White Zig Zag CC-229 - Copper Penny CC-003 - Black and White Houndstooth CC-XXX - Custom Cord Color	RS-36-DOME - 36" Rigid Stem  RS-48-DOME - 48" Rigid Stem  RS-96-DOME - 96" Rigid Stem  RS-CL-DOME - Custom Length (up to 120")	WL - White Stem BM - Black Stem SL - Silver Stem CC - Custom Color

NOTES (1) Only product configurations with this designation prefix are built to be compliant with the Trade Agreements Act of 1979 (TAA). Please refer to DOMESTIC PREFERENCES website for more information. Components shipped separately analyzed under domestic preference requirements. (2) Field Selectable CCT. (3) Not available for installations in locations such as gymnasiums, arenas, sports complexes, multipurpose rooms, and any other locations where the fixture potentially will be subject to impacts from external sources. Please consult factory for those applications.

Specifications and dimensions subject to change without notice. See additional information on the following pages.

See page 2 for Technical Notes.

**MOUNTING OPTIONS**

**COLOR POWER CORD**

**CC-XXX**

Decorative power cord

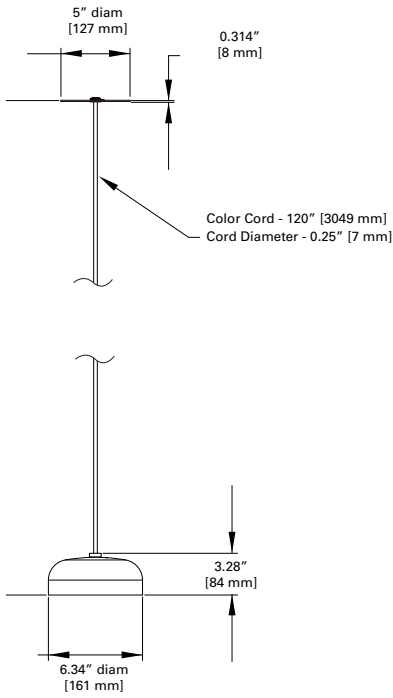

**RIGID STEM**

**1400 - 36"**

Rigid Stem for 36" length

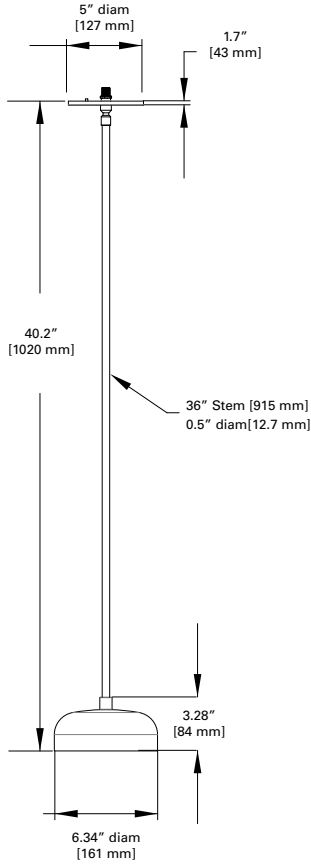

**1400 - 48"**

Rigid Stem for 48" length

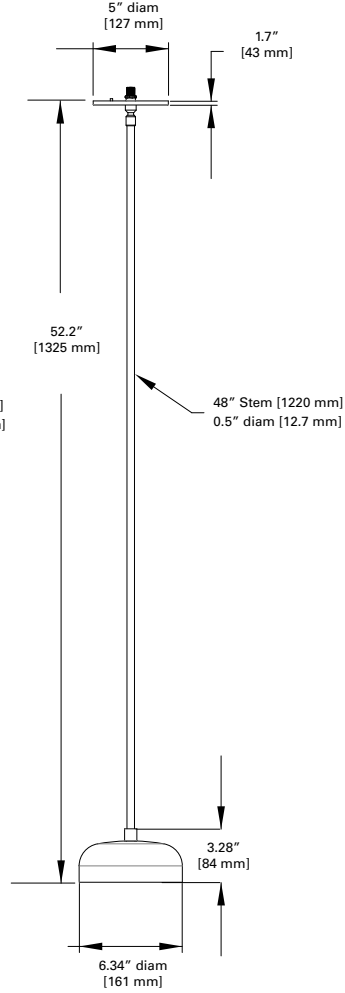

**1400 - 96"**

Rigid Stem for 96" length

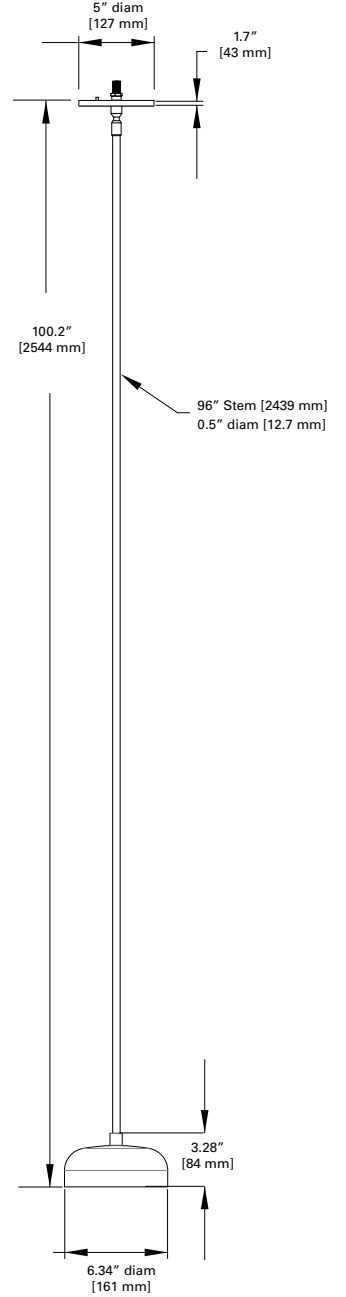

**VIEWS**

Canopy Views

Fixture Head Plan View

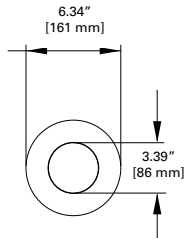

Color Cord

Rigid Stem

**FINISHES PAINTED AND METALS**

Painted finish is "High Gloss" sheen. A clear coat protectant is applied over the Copper Spun and Brushed Aluminum metal finishes.



**RR**  
Real Red  
RAL # 3020  
Pantone 485  
(Traffic Red)



**OC**  
Orange Crush  
RAL#: 2004  
Pantone 1655  
(Pure Orange)

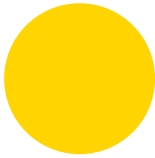

**YE**  
Yello?  
RAL#: 1018  
Pantone 123  
(Zinc Yellow)



**AL**  
Avocado Lime  
RAL#: FGS860016  
Pantone 15-0343  
(Greenery)



**SS**  
Seafoam See  
RAL#: 6027  
Pantone 631  
(Light Green)

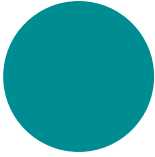

**TT**  
Totally Turquoise  
RAL#: 5018  
Pantone 3145  
(Turquoise Blue)

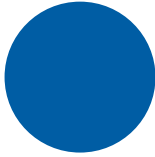

**EB**  
Eaton Blue  
RAL#: 5017  
Pantone 2945  
(Traffic Blue)

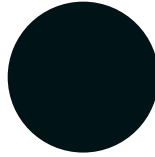

**BM**  
Black Metal  
RAL#: 9005  
Pantone Black  
(Jet Black)

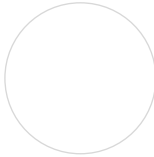

**WL**  
White Light  
RAL#: 9003  
Pantone 705  
(Signal White)

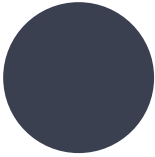

**CG**  
Charcoal Gray  
RAL#: 7024  
Pantone 432  
(Graphite Grey)



**CS**  
Copper Spun  
(Authentic Copper  
Metal with clear coat)

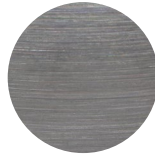

**BA**  
Brushed Aluminum  
(with clear coat)

**COLOR POWER CORD OPTIONS**



**CC-620**  
Red



**CC-401**  
Cobalt  
Blue



**CC-001**  
Black



**CC-810**  
Orange



**CC-510**  
Purple



**CC-029**  
Gunmetal  
Silver



**CC-710**  
Yellow Gold



**CC-540**  
Magenta



**CC-119**  
Pearl



**CC-320**  
Lime Green



**CC-229**  
Copper Penny



**CC-002**  
Black & White  
Zig Zag



**CC-031**  
Gray Tweed



**CC-003**  
Black & White  
Houndstooth

PHOTOMETRY

SHAPER 1400 3500K/80CRI	
Filename	1400-DOME-80-L35-120.ies
Test No.	P237905
Lumcat	1400-DOME-80-L35-120
Lumens	780 Lm
Watts	12.2 W
LPW	63.9 Lm/W
CCT	3500K
SC (0/90/45)	1.42 / 1.42 / 1.48
Beam Angle	110.4°
CBCP	260 cd

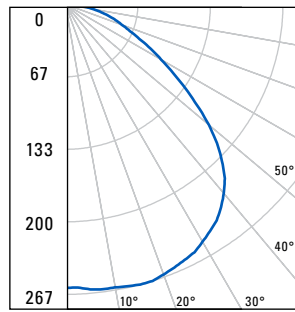

ZONAL LUMENS SUMMARY		
Zone	Lumens	% Fixture
0-30	220	28.2
0-40	371	47.6
0-60	648	83.1
0-90	780	100
90-180	0	0
0-180	780	100

LUMINANCE DATA			
Angle	0°	45°	90°
45	35515	35515	35515
55	28924	28924	28924
65	21919	21919	21919
75	19635	19635	19635
85	15426	15426	15426

0° AIMING ANGLE HORIZONTAL ILLUMINANCE ON FLOOR			
MH	FC	L	W
2'	65.1	2.8	2.8
4'	16.3	5.6	5.6
6'	7.2	8.4	8.4
8'	4.1	11	11
10'	2.6	14	14
15'	1.2	21	21
20'	0.7	28	28
30'	0.3	43	43
40'	0.2	57	57

SHAPER 1400 3500K/90CRI	
Filename	1400-DOME-90-L35-120.ies
Test No.	P237909
Lumcat	1400-DOME-90-L35-120
Lumens	690 Lm
Watts	12 W
LPW	57.5 Lm/W
CCT	3500K
SC (0/90/45)	1.42 / 1.42 / 1.48
Beam Angle	110.4°
CBCP	230 cd

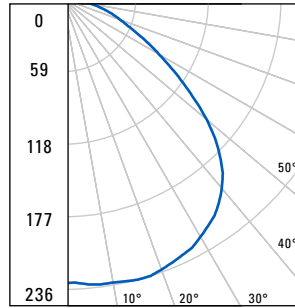

ZONAL LUMENS SUMMARY		
Zone	Lumens	% Fixture
0-30	195	28.2
0-40	328	47.6
0-60	573	83.1
0-90	690	100
90-180	0	0
0-180	690	100

LUMINANCE DATA			
Angle	0°	45°	90°
45	31416	31416	31416
55	25591	25591	25591
65	19409	19409	19409
75	17347	17347	17347
85	13586	13586	13586

0° AIMING ANGLE HORIZONTAL ILLUMINANCE ON FLOOR			
MH	FC	L	W
2'	57.6	2.8	2.8
4'	14.4	5.6	5.6
6'	6.4	8.4	8.4
8'	3.6	11	11
10'	2.3	14	14
15'	1	21	21
20'	0.6	28	28
30'	0.3	43	43
40'	0.1	57	57