

Project		Catalog #		Type	
Prepared by		Notes		Date	



HALO Commercial

HC6 | HM6 | 61 | 61PS

6-inch LED downlight and wall wash

Typical Applications

Office • Healthcare • Hospitality • Institutional • Mixed-Use/Retail

Interactive Menu

- Order Information [page 2](#)
- Product Specifications [page 4](#)
- Photometric Data [page 5](#)
- Energy & Performance Data [page 8](#)
- Connected Systems [page 10](#)
- Product Warranty

Top Product Features

- New construction/remodel series; 500 to 6,000 lumens
- Narrow, Medium and Wide distributions; Wall wash with rotatable linear spread lens
- 2700K, 3000K, 3500K, 4000K, 5000K CCT; 80 or 90 CRI
- Universal voltage 120V-277V; Standard 0-10V driver dims to 1%
- Mounting frame converts to remodel that installs from below the ceiling
- Quick Spec emergency backup mounting frames - fast delivery option

Product Certification



Product Features



Control Compatibility



Dimensional and Mounting Details

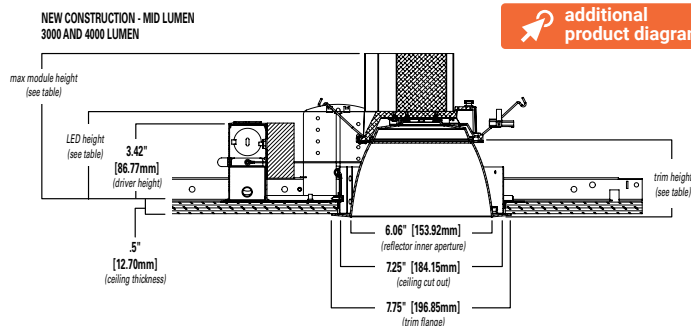
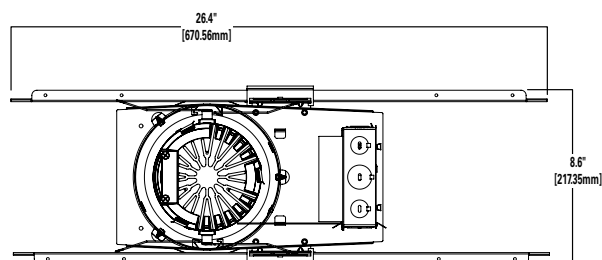

additional product diagrams

Mid Lumen (3000 – 4000 Lumens)

Distribution	Max. Module Height	Trim Height	LED Height
Narrow	6.6"	3.4"	3.8"
Medium	6.7"	3.5"	3.9"
Wide	6.5"	3.3"	3.7"
Baffle	6.5"	3.3"	3.7"

Mounting Frame Order Information

Sample Number: **HC620D010REM7 – HM60525835 - 61MDC**

A complete luminaire consists of a housing frame, LED module, and reflector (ordered separately)

Mounting Frame	Lumens	Driver Options	Factory Installed Emergency & Connected Lighting Options	Accessories (Order & Install Separately)
<p>HC6 = 6" new construction downlight housing</p> <p>HC6CP = 6" new construction housing, Chicago Plenum - CCEA compliant</p>	<p>05 = 500 lm</p> <p>07 = 750 lm</p> <p>10 = 1000 lm</p> <p>15 = 1500 lm</p> <p>20 = 2000 lm</p> <p>25 = 2500 lm</p> <p>30 = 3000 lm</p> <p>35 = 3500 lm</p> <p>40 = 4000 lm</p> <p>45 = 4500 lm ⁽⁷⁾</p> <p>50 = 5000 lm ⁽⁷⁾</p> <p>55 = 5500 lm ⁽⁷⁾</p> <p>60 = 6000 lm ⁽⁷⁾</p>	<p>D010=UNV 120-277V, 50/60Hz, 0-10V 1%-100% dimming at 120-277V on 0-10V controls</p> <p>Canada Option 500-5000 lumens: D010347 = 347VAC 50/60Hz 0-10V 1%-100% dimming. For 500, 750, 1000, 1500, 2000, 2500, 3000, 3500, 4000, 4500, 5000lm models only ⁽¹⁾</p> <p>Canada Option 5500-6000 lumens: D010X347 = step down transformer factory installed (with standard "D010" 120V-277V LED driver). For 5500, 6000lm models only ⁽¹⁾</p> <p>DLV = Distributed Low Voltage dimming driver 1%-100%, 1000-4000 lumens only. For use with DLVP system only, refer to DLVP specifications for details. ⁽¹⁾</p>	<p>REM7 = 7 watt emergency battery pack with remote test / indicator light, use with D010 only ^{(1) (2) (6)}</p> <p>REM14 = 14 watt emergency battery pack with remote test / indicator light, use with D010 only ^{(1) (2) (6)}</p> <p>IEM7 = 7 watt emergency battery pack with integral test / indicator light, use with D010 only ^{(1) (2) (6)}</p> <p>IEM14 = 14 watt emergency battery pack with integral test / indicator light, use with D010 only ^{(1) (2) (6)}</p> <p>BOD7ST = 7.5 watt Bodine self-test emergency battery pack with remote test / indicator light, use with D010 only ^{(1) (2) (6)}</p> <p>WTA = Factory WaveLinX PRO Tilemount Sensor Kit ⁽⁴⁾</p> <p>WTK = Factory WaveLinX LITE Tilemount Sensor Kit ⁽⁵⁾</p> <p>WPN = WaveLinX PRO Wireless Node without Sensor ⁽⁹⁾</p> <p>WLN = WaveLinX LITE Wireless Node without Sensor ⁽¹⁰⁾</p> <p>REM7V = 7 watt emergency battery pack with remote test / indicator light, use with DLV only ^{(1) (2) (3) (6)}</p> <p>REM14V = 14 watt emergency battery pack with remote test / indicator light, use with DLV only ^{(1) (2) (3) (6)}</p> <p>IEM7V = 7 watt emergency battery pack with integral test / indicator light, use with DLV only ^{(1) (2) (3) (6)}</p> <p>IEM14V = 14 watt emergency battery pack with integral test / indicator light, use with DLV only ^{(1) (2) (3) (6)}</p>	<p>HB128APK = L channel hanger bar, 26", pair (replacement)</p> <p>RB22 = Adjustable wood joist mounting bars, pair, extend to 22" long</p> <p>HSA6 = Slope Adapter for 6" Aperture Housings, Specify Slope (refer to instructions for installing housing and trim)</p> <p>H347 = 347 to 120V step down transformer, 75VA</p> <p>H347200 = 347 to 120V step down transformer, 200VA</p> <p>WTA = Field WaveLinX PRO Tilemount Sensor Kit ⁽⁴⁾</p> <p>WTK = Field WaveLinX LITE Tilemount Sensor Kit ⁽⁵⁾</p>
Notes	Notes	Notes	Notes	Notes
	<p>(7) Marked Spacing: Center to Center of Adjacent Luminaires = 36" Center of Luminaire to Building Member = 18" Minimum overhead = 0.5</p>	<p>(1) Not available with CP models</p>	<p>(1) Not available with CP models</p> <p>(2) Not available with D010347 (347V models)</p> <p>(3) ULus for U.S. only</p> <p>(4) WTA = WaveLinX PRO tilemount sensor kit for daylight dimming, PIR motion sensing, and optional RLTS - Real Time Location Services, use with D010 only. (Refer to WaveLinX PRO specifications.)</p> <p>(5) WTK = WaveLinX LITE tilemount sensor kit for daylight dimming, PIR motion sensing, use with D010 only. (Refer to WaveLinX LITE specifications.)</p> <p>(6) Emergency battery backup options are Non-IC only, and rated for a minimum starting temperature of 0°C</p> <p>(9) WPN = WaveLinX PRO wireless node provides luminaire-level control with scene and zone configuration without an integrated sensor; Connects wirelessly with daylight dimming sensor and PIR motion sensor if desired. Use with 0-10V driver only. Not compatible with 347V or Chicago plenum. (Refer to WaveLinX PRO specifications.)</p> <p>(10) WLN = WaveLinX LITE wireless node provides luminaire-level control with scene and zone configuration without an integrated sensor; Connects wirelessly with daylight dimming sensor and PIR motion sensor if desired. Use with 0-10V driver only. Not compatible with 347V or Chicago plenum. (Refer to WaveLinX LITE specifications.)</p>	<p>(4) WTA = WaveLinX PRO tilemount sensor kit for daylight dimming, PIR motion sensing, and optional RLTS - Real Time Location Services, use with D010 only. (Refer to WaveLinX PRO specifications.)</p> <p>(5) WTK = WaveLinX LITE tilemount sensor kit for daylight dimming, PIR motion sensing, use with D010 only. (Refer to WaveLinX LITE specifications.)</p>

Quick Spec Emergency Mounting Frame Order Information

Sample Number :

Quick Spec Emergency Mounting Frame: **RR-HC620D010REM7**

LED module and reflectors are ordered separately.

Order separately: LED Module: HM60525835 | Reflector: 61MDC

Select from the Quick Spec Mounting Frame ordering information to receive the *Fast Delivery* option for the frame.

Quick Spec Code	Mounting Frame	Lumens	Driver Options	Factory Installed Emergency & Connected Lighting Options	Accessories (Order & Install Separately)
<p>RR = East Region</p> <p>BRR = West Region</p>	<p>HC6 = 6" new construction downlight housing</p>	<p>10 = 1000 lm</p> <p>15 = 1500 lm</p> <p>20 = 2000 lm</p> <p>30 = 3000 lm</p> <p>40 = 4000 lm</p>	<p>D010=UNV 120-277V, 50/60Hz, 0-10V 1%-100% dimming at 120-277V on 0-10V controls</p>	<p>REM7 = 7 watt emergency battery pack with remote test / indicator light, use with D010 only ^{(2) (6)}</p> <p>REM14 = 14 watt emergency battery pack with remote test / indicator light, use with D010 only ^{(2) (6)}</p> <p>IEM7 = 7 watt emergency battery pack with integral test / indicator light, use with D010 only ^{(2) (6)}</p> <p>IEM14 = 14 watt emergency battery pack with integral test / indicator light, use with D010 only ^{(2) (6)}</p>	<p>HB128APK = L channel hanger bar, 26", pair (replacement)</p> <p>RB22 = Adjustable wood joist mounting bars, pair, extend to 22" long</p>
Notes	Notes	Notes	Notes	Notes	Notes
				<p>(2) Not available with D010347 (347V models)</p> <p>(6) Emergency battery backup options are Non-IC only, and rated for a minimum starting temperature of 0°C</p>	

LED Module Order Information

LED Module	Lumens	CRI/CCT	
HM6 = 6" LED Modules For use with HC6 - HC6CP New Construction housings only	0525 = 500 - 2500 lumen 3040 = 3000-4000 lumen 4560 = 4500-6000 lumen	827 = 80CRI, 2700K 830 = 80CRI, 3000K 835 = 80CRI, 3500K 840 = 80CRI, 4000K 850 = 80CRI, 5000K	927 = 90CRI, 2700K 930 = 90CRI, 3000K 935 = 90CRI, 3500K 940 = 90CRI, 4000K 950 = 90CRI, 5000K
Notes	Notes	Notes	

Trim Order Information

Reflector	Distribution ⁽⁸⁾	Finish	Flange	Accessories
61 = 6" conical reflector	ND = narrow 55° beam angle 0.97 SC MD = medium 60° beam angle 1.10 SC WD = wide 65° beam angle 1.28 SC RWW = rotatable wall wash with linear spread lens	C = Specular clear H = Semi-specular clear W = White	Blank = Polished flange standard with C & H reflectors Blank = White flange standard with W reflector WF = White flange option available with C & H reflectors	61RWWPK = Replacement part kit - wall wash lens insert - for use with 61RWW* only.
Notes	Notes <small>(8) Values are nominal, with specular clear reflector, other finishes and field results may vary.</small>	Notes	Notes	Notes

Baffle	Distribution ⁽⁸⁾	Finish	Flange	Accessories
61 = 6" baffle reflector	WD = wide 65° beam angle 1.28 SC (nominal) RWW = rotatable wall wash with linear spread lens	BB = Black baffle WB = White baffle	Blank = White flange standard with BB, & WB BF = Black flange option available with BB	61RWWPK = Replacement part kit - wall wash lens insert - for use with 61RWW* only.
Notes	Notes <small>(8) Values are nominal, with specular clear reflector, other finishes and field results may vary.</small>	Notes	Notes	Notes

Reflector	Distribution ⁽⁸⁾	Finish	Flange
61PS = 6" non-conductive polymer 'dead front' conical reflector ⁽⁹⁾	MD = medium 60° beam angle 1.10 SC (nominal)	W = White	Blank = White flange standard with W reflector
Notes <small>(9) 61PS is 1000-2000 lumens Non-IC rated. 500 & 750 lumens IC rated. 61PS is not for use over 2000lm in Non-IC or over 750lm in IC.</small>	Notes <small>(8) Values are nominal, with specular clear reflector, other finishes and field results may vary.</small>	Notes	Notes

IEM Reflector	Distribution ⁽⁸⁾	Finish	Flange	Integral Emergency
61 = 6" IEM reflector for integral emergency only	ND = narrow 55° beam angle 0.97 SC MD = medium 60° beam angle 1.10 SC WD = wide 65° beam angle 1.28 SC	C = Specular clear H = Semi-specular clear W = White	Blank = Polished flange standard with C & H reflectors Blank = White flange standard with W reflector WF = White flange option available with C & H reflectors	IEM = Reflector for use with integral emergency housings only. Provides access hole for integral emergency test switch.
Notes	Notes <small>(8) Values are nominal, with specular clear reflector, other finishes and field results may vary.</small>	Notes	Notes	Notes

IEM Baffle	Distribution ⁽⁸⁾	Finish	Flange	Integral Emergency
61 = 6" IEM baffle reflector for integral emergency only	WD = wide 65° beam angle 1.28 SC (nominal)	BB = Black baffle WB = White baffle	Blank = White flange standard with BB, & WB BF = Black flange option with BB	IEM = Reflector for use with integral emergency housings only. Provides access hole for integral emergency test switch.
Notes	Notes <small>(8) Values are nominal, with specular clear reflector, other finishes and field results may vary.</small>	Notes	Notes	Notes

Product Specifications

Housing Frame

- Boat shaped galvanized steel plaster frame with adjustable plaster lip
- Accommodates 1/2" to 1-1/2" thick ceilings
- Installs in new construction or from below the finished ceiling (non-accessible) for remodeling (with mounting bars removed)
- Provided with two remodel clips to secure the frame to the ceiling

Universal Mounting Bracket

- Adjusts 2" vertically from above and below the ceiling
- Use with the included mounting bars or with 1/2" Electric Metallic Tube (EMT)
- Removable to facilitate remodeling installation from below the finished ceiling

Mounting Bars

- Captive pre-installed No Fuss™ mounting bars lock to T-grid with screwdriver or pliers
- Centering detents allow for consistent positioning of fixtures

LED Module

- Proximity phosphors over chip on board LEDs provide a uniform source with high efficiency and no pixilation
- Available in 80 or 90 color rendering index (CRI)
- Color accuracy within 3 SDCM provides color consistency and uniformity
- 90 CRI option: R9>50 (refer to chromaticity information for details)
- Available in 2700K, 3000K, 3500K, 4000K and 5000K correlated color temperature (CCT)
- Lumen options include 500, 750, 1000, 1500, 2000, 2500, 3000, 3500, 4000, 4500, 5000, 5500, 6000 lumens (nominal)
- Passive thermal management achieves 60,000 hours at 70% lumen maintenance (L70) in insulated ceilings (IC) and non-IC applications
- Integral diffuse lens provides visual shielding
- Integral connector allows quick connection to housing flex

Reflector

- Self-flanged aluminum reflectors available in narrow, medium or wide distribution patterns
- Medium distribution polymer non-conductive matte white reflector may be used to meet local codes for 'dead front' applications (500 & 750 lumen max. in IC and 2000 lumen max. in Non-IC)
- Wall wash reflector features a rotatable linear spread lens for alignment of vertical illumination
- Reflectors attach to LED module with three speed clamps
- Available in multiple painted or plated finishes

Reflector/Module Retention

- Reflector/module assembly is securely retained in the housing with two torsion springs

Driver

- Field-replaceable constant current driver provides low noise operation
- Universal 120-277VAC 50/60Hz input standard
- Continuous, 1% to 100% dimming with 0-10V analog control
- Optional low-voltage DC driver for use with Distributed Low Voltage Power (DLVP) system
- Distributed Low Voltage Power (DLVP) system combines power, lighting and controls with ease of installation (refer to DLVP Design Guide at www.cooperlighting.com for details)

Canada Options

- 347VAC 50/60Hz; 1% dimming on 0-10V analog control, for 500, 750, 1000, 1500, 2000, 2500, 3000, 3500, 4000, 4500, 5000 lumen models only
- 347V step down transformer factory installed with the standard "D010" 120V-277V, LED driver on 5500, 6000 lumen models only

Emergency Option

- Provides 90 minutes of standby lighting, meeting most life safety codes for egress lighting
- Available with integral or remote charge indicator and test switch
- Available Self-Test (self-diagnostic) with remote charge indicator and test switch
- Quick Spec emergency ordering option for quick-turn projects

Connected Lighting System

Two WaveLinx connected solutions to choose from. Refer to WaveLinx system specifications and application guides for details.

WaveLinx PRO Tilemount Sensor Kit

- WaveLinx PRO WTA tilemount sensor kit offers daylight dimming, PIR motion sensing, scene and zone configuration, automatic commissioning; and optional RLTS - Real Time Location Services available.

WaveLinx PRO Wireless Node

- WaveLinx PRO WPN wireless node provides luminaire-level control with scene and zone configuration without an integrated sensor; Connects wirelessly with daylight dimming sensor and PIR motion sensor if desired. Use with 0-10V driver only. **Note:** Not compatible with 347V or Chicago plenum.

WaveLinx LITE Tilemount Sensor Kit

- WaveLinx LITE WTK tilemount sensor kit offers daylight dimming and PIR motion sensing, scene and grouping configuration.

WaveLinx LITE Wireless Node

- WaveLinx LITE WLN wireless node provides luminaire level control with scene and zone configuration without an integrated sensor; Connects wirelessly with daylight dimming sensor and PIR motion sensor if desired. Use with 0-10V driver only. **Note:** Not compatible with 347V or Chicago plenum.

WaveLinx Tilemount Sensor Kits Application

- The WTA and WTK tilemount sensor kits include a control module mounted on the luminaire junction box via 1/2" knock-out, and a tilemount sensor on 54-inch whip; for ceiling installation by direct-mount spring clips or via mounting bracket in octagon ceiling boxes.
- The WTA and WTK tilemount sensor kits may be ordered as factory installed on the luminaire, or ordered separately as a field installed accessory kit.
- **Note: WaveLinx PRO devices are only compatible with the WaveLinx PRO system.**
- **Note: WaveLinx LITE devices are only compatible with the WaveLinx LITE system.**

Junction Box

- Galvanized steel junction box
- 20 in³ internal volume excluding voltage barrier
- 25 in³ internal total volume
- Voltage barrier for 0-10V dimming wires (occupies one 1/2" pry-out space)
- Listed for eight #12 AWG (four in, four out) 90°C conductors and feed-thru branch wiring
- Three 1/2" and two 3/4" trade size pry-outs available
- Three 4-port push wire nuts for mains voltage with 1-port for fixture connection

Compliance

- cULus Certified to UL 1598 / C22.2 No. 250.0, suitable for damp locations and wet locations in covered ceilings only
- Emergency options provided with UL Listed emergency drivers to UL 924 / C22.2 No. 141, suitable for indoor/damp locations
- IP20 - Above finished ceiling; IP65 - Below finished ceiling
- Non-Insulated ceiling (Non-IC) rated for 2500, 3000, 3500, 4000, 4500, 5000, 5500, 6000 lumen models (insulation must be kept 3" from top and sides)
- Insulated ceiling (IC) rated for 500, 750, 1000, 1500, 2000 lumen models and suitable for direct contact with air permeable insulation* (IC models are also suitable for Non-IC installations)
- Non-IC marked spacing required for 4500, 5000, 5500, 6000 lumen models
 - Marked Spacing Center to Center of Adjacent Luminaires = 36"
 - Center of Luminaire to Building Member = 18"
 - Minimum overhead = 0.5"
- Airtight per ASTM-E283-04
- Suitable for use in clothes closets when installed in accordance with the NEC 410.16 spacing requirements
- EMI/RFI emissions FCC CFR Title 47 Part 15 Class A at 120/277V
- Contains no mercury or lead and RoHS compliant
- Photometric testing completed in accordance of IES LM-79-08
- Lumen maintenance projection in accordance of IES LM-80-08 and TM-21-11
- 500, 750, 1,000, 1,500 and 2,000 lumen, 90 CRI, ICAT models may be used to comply with State of California Title 24 residential code, per JA8 certification standards
- May be used to comply with State of California Title 24 non-residential code as a dimmable LED luminaire
- ENERGY STAR® certified, reference certified light fixtures database
- *Not for use in direct contact with spray foam insulation, consult NEMA LSD57-2013

Warranty

- Five year limited warranty, consult website for details. www.cooperlighting.com/legal

Photometric Data

 View IES files

NARROW DISTRIBUTION - SPECULAR CLEAR FINISH, 2000 LUMEN MODEL, 80 CRI, 3500K

NARROW (55° BEAM*)	
Test Number	P581878
Housing	HC620D010
Module	HM60525835
Reflector	61NDC
Lumens	2228 Lm
Efficacy	111.4 Lm/W
SC	0.93
UGR	11.7

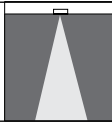
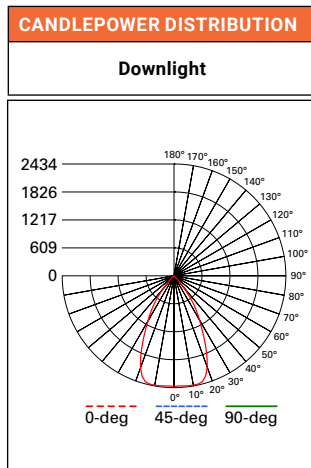
CONE OF LIGHT				
				
MH	FC	L	W	
5.5'	80.2	5	5	
7'	49.5	6.4	6.4	
8'	37.9	7.4	7.4	
9'	30	8.2	8.2	
10'	24.3	9.2	9.2	
12'	16.9	11	11	

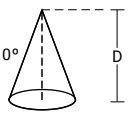
CANDELA TABLE	
Degrees Vertical	Candela
0	2427
5	2422
15	2405
25	1621
35	761
45	118
55	12
65	3
75	2
85	0
90	0

ZONAL LUMEN SUMMARY		
Zone	Lumens	% Fixture
0-30	1636	73.4
0-40	2098	94.2
0-60	2223	99.8
0-90	2228	100
90-180	0	0
0-180	2228	100

LUMINANCE	
Average Candela Degrees	Average 0° Luminance
45	9187
55	1118
65	376
75	318
85	0

MEDIUM DISTRIBUTION - SPECULAR CLEAR FINISH, 2000 LUMEN MODEL, 80 CRI, 3500K

MEDIUM (60° BEAM*)	
Test Number	P581875
Housing	HC620D010
Module	HM60525835
Reflector	61MDC
Lumens	2307 Lm
Efficacy	115.3 Lm/W
SC	1.06
UGR	11.8

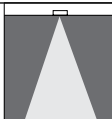
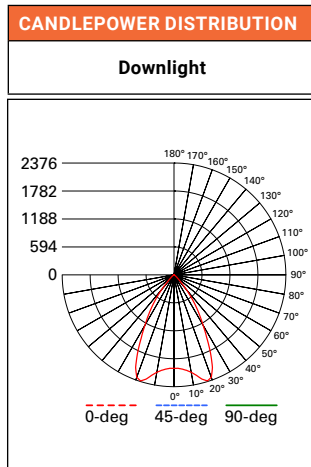
CONE OF LIGHT				
				
MH	FC	L	W	
5.5'	68.7	5.6	5.6	
7'	42.4	7.2	7.2	
8'	32.5	8.2	8.2	
9'	25.7	9.4	9.4	
10'	20.8	10.4	10.4	
12'	14.4	12.4	12.4	

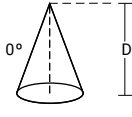
CANDELA TABLE	
Degrees Vertical	Candela
0	1998
5	2022
15	2307
25	1842
35	796
45	126
55	15
65	4
75	2
85	0
90	0

ZONAL LUMEN SUMMARY		
Zone	Lumens	% Fixture
0-30	1671	72.4
0-40	2163	93.8
0-60	2301	99.7
0-90	2307	100
90-180	0	0
0-180	2307	100

LUMINANCE	
Average Candela Degrees	Average 0° Luminance
45	9753
55	1395
65	571
75	318
85	0

Photometric Data

[View IES files](#)

WIDE DISTRIBUTION - SPECULAR CLEAR FINISH, 2000 LUMEN MODEL, 80 CRI, 3500K

WIDE (65° BEAM*)	
Test Number	P581885
Housing	HC620D010
Module	HM60525835
Reflector	61WDC
Lumens	2359 Lm
Efficacy	118 Lm/W
SC	1.28
UGR	11.6

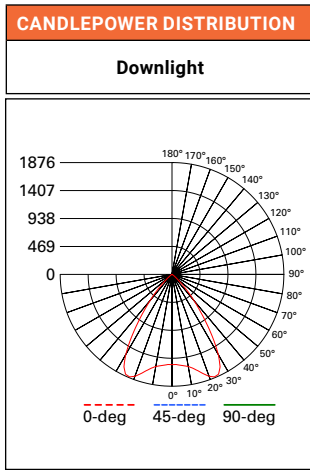

CONE OF LIGHT				
MH	FC	L	W	
5.5'	50.5	7	7	
7'	31.2	8.8	8.8	
8'	23.9	10.2	10.2	
9'	18.8	11.4	11.4	
10'	15.3	12.8	12.8	
12'	10.6	15.4	15.4	

CANDELA TABLE	
Degrees Vertical	Candela
0	1526
5	1540
15	1685
25	1861
35	1027
45	252
55	32
65	6
75	2
85	0
90	0

ZONAL LUMEN SUMMARY		
Zone	Lumens	% Fixture
0-30	1461	61.9
0-40	2105	89.2
0-60	2351	99.6
0-90	2359	100
90-180	0	0
0-180	2359	100

LUMINANCE	
Average Candela Degrees	Average 0° Luminance
45	19506
55	3078
65	765
75	318
85	0

*Value are nominal with specular clear reflectors, other finishes and field results may vary.
 SC = Spacing Criteria
 UGR = Unified Glare Rating

Photometric Multipliers (Nominal Lumen Values)

500 Lumen	750 Lumen	1000 Lumen	1500 Lumen	2000 Lumen	2500 Lumen	3000 Lumen	3500 Lumen
0.33	0.44	0.54	0.74	1.00	1.12	1.46	1.76

4000 Lumen	4500 Lumen	5000 Lumen	5500 Lumen	6000 Lumen
1.81	2.17	2.28	2.38	2.65

Multipliers for relative lumen values with other series models.

Color Finish Multipliers

Finish code	C	H	W/WB	BB
Finish	Specular Clear	Semi-Specular	Matte White White Baffle	Black Baffle
Multiplier	1.00	0.92	0.91	0.82

Multipliers for relative lumen values with other color finishes.

CCT Multipliers – 80CRI

2700K	3000K	3500K	4000K	5000K
0.92	0.98	1.00	1.03	1.03

Multipliers for relative lumen values with other series color temperatures.

CCT Multipliers – 90CRI

2700K	3000K	3500K	4000K	5000K
0.77	0.84	0.89	0.90	0.90

Multipliers for relative lumen values with other series color temperatures.

Note: Refer to IES files for more product data.

Photometric Data

[View IES files](#)

WALL WASH DISTRIBUTION - SPECULAR CLEAR FINISH, 2000 LUMEN MODEL, 80 CRI, 3500K

WALL WASH	
Test Number	P581882
Housing	HC620D010
Module	HM60525835
Reflector	61RWWC
Lumens	2179 Lm
Efficacy	109 Lm/W
SC	1.15

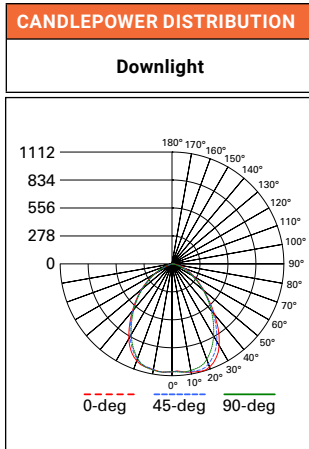
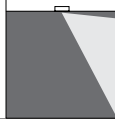

CANDELA TABLE	
Degrees Vertical	Candela
0	1080
5	1081
15	1112
25	1034
35	800
45	514
55	319
65	184
75	85
85	12
90	0

ZONAL LUMEN SUMMARY		
Zone	Lumens	% Fixture
0-30	849	39
0-40	1313	60.2
0-60	1978	90.8
0-90	2179	100
90-180	0	0
0-180	2179	100

LUMINANCE	
Average Candela Degrees	Average 0° Luminance
45	39810
55	30479
65	23907
75	17983
85	7359

SC = Spacing Criteria, nominal for specular clear reflector, other finishes and field results may vary.

SINGLE UNIT FOOTCANDLES								
2.5' from wall (distance from fixture along wall)								
1	19.3	13.8	6.1	2.2	0.7	0.3	0.1	
2	29.1	22.6	12.3	5.7	2.5	1.2	0.6	
3	27.6	22.5	13.8	7.3	3.7	1.9	1	
4	21	18.2	12.4	7.4	4.2	2.4	1.4	
5	14.4	13.1	9.9	6.6	4.1	2.5	1.6	
6	9.7	9.1	7.5	5.5	3.7	2.5	1.6	
7	6.7	6.4	5.5	4.3	3.2	2.2	1.5	
8	4.7	4.6	4.1	3.4	2.7	2	1.4	
9	3.4	3.3	3.1	2.7	2.2	1.7	1.3	
10	2.5	2.5	2.4	2.1	1.8	1.4	1.1	

MULTIPLE UNIT FOOTCANDLES								
2.5' from wall (Distance from fixture along 3')				2.5' from wall (Distance from fixture along 4')				
1	21.5	19.1	21.5	20	12.1	20		
2	34.7	34.4	34.7	31.6	24.6	31.6		
3	34.9	36	34.9	31.3	27.6	31.3		
4	28.4	30.7	28.4	25.2	24.8	25.2		
5	21	23.2	21	18.6	19.8	18.6		
6	15.2	16.8	15.2	13.4	15	13.4		
7	11	12	11	9.9	11	9.9		
8	8.1	8.7	8.1	7.4	8.2	7.4		
9	6.1	6.5	6.1	5.6	6.2	5.6		
10	4.6	4.9	4.6	4.3	4.7	4.3		

Photometric Multipliers (Nominal Lumen Values)

500 Lumen	750 Lumen	1000 Lumen	1500 Lumen	2000 Lumen	2500 Lumen	3000 Lumen	3500 Lumen
0.33	0.44	0.54	0.74	1.00	1.12	1.46	1.76

4000 Lumen	4500 Lumen	5000 Lumen	5500 Lumen	6000 Lumen
1.81	2.17	2.28	2.38	2.65

Multipliers for relative lumen values with other series models.

Color Finish Multipliers

Finish code	C	H	W/WB	BB
Finish	Specular Clear	Semi-Specular	Matte White White Baffle	Black Baffle
Multiplier	1.00	0.92	0.91	0.82

Multipliers for relative lumen values with other color finishes.

CCT Multipliers - 80CRI

2700K	3000K	3500K	4000K	5000K
0.92	0.98	1.00	1.03	1.03

Multipliers for relative lumen values with other series color temperatures.

CCT Multipliers - 90CRI

2700K	3000K	3500K	4000K	5000K
0.77	0.84	0.89	0.90	0.90

Multipliers for relative lumen values with other series color temperatures.

Note: Refer to IES files for more product data.

Energy & Performance Data

COLOR METRICS - TM-30-15 & CRI/CIE (3500K)

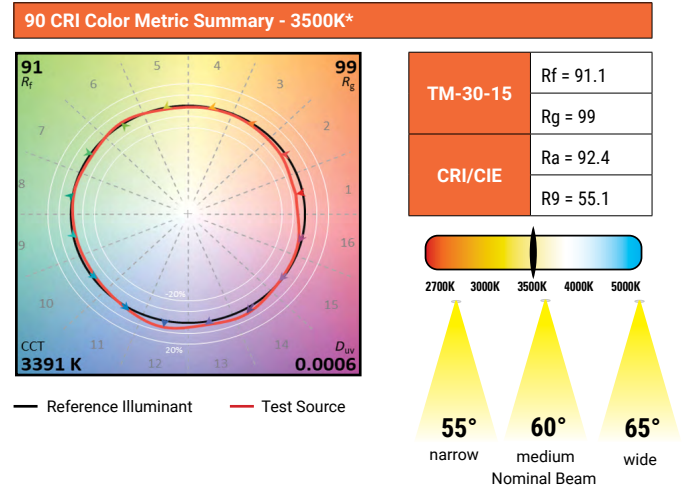
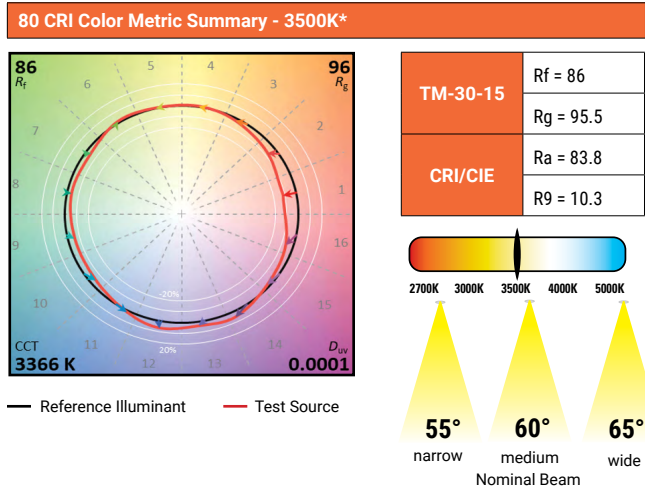

* Color values are based on 61WDWB reflector, other finishes and field results may vary.

ENERGY DATA

Series	500 lumen		750 lumen		1000 lumen		1500 lumen		2000 lumen	
	120V	277V	120V	277V	120V	277V	120V	277V	120V	277V
Input Voltage 120-277VAC	120V	277V	120V	277V	120V	277V	120V	277V	120V	277V
Input Current (A)	0.051	0.026	0.067	0.036	0.083	0.039	0.119	0.053	0.171	0.077
Input Power (W)	6.1	6.5	7.9	8.3	10	10.4	14.5	14.5	20.9	20.6
In-rush (A)	1.9	8.4	2	8.4	2.2	8.5	2.7	8.5	2.1	9.7
Inrush duration (µs)	251	135	237	133	250	134	250	139	245	131
THD (%)	6.2	13.5	7.4	8.8	5.4	10.3	10	6.7	6.5	7.9
PF	≥ 0.99	≥ 0.9	≥ 0.98	≥ 0.92	≥ 0.99	≥ 0.95	≥ 0.99	≥ 0.97	≥ 0.99	≥ 0.96

Series	2500 lumen		3000 lumen		3500 lumen		4000 lumen		4500 lumen	
	120V	277V	120V	277V	120V	277V	120V	277V	120V	277V
Input Voltage 120-277VAC	120V	277V	120V	277V	120V	277V	120V	277V	120V	277V
Input Current (A)	0.23	0.103	0.24	0.107	0.292	0.152	0.351	0.159	0.384	0.172
Input Power (W)	27.5	27.5	28.6	28.5	34.6	35.1	42.1	42.1	45.9	45.6
In-rush (A)	2.5	5.6	2.5	11.6	3.4	13.9	3.1	14.7	3.1	14.8
Inrush duration (µs)	232	123	216	111	183	95	200	98	202	100
THD (%)	6.5	8.1	7.8	8.3	5.6	10	4.1	9.5	4.5	8.5
PF	≥ 0.99	≥ 0.96	≥ 0.99	≥ 0.96	≥ 0.99	≥ 0.93	≥ 0.99	≥ 0.94	≥ 0.99	≥ 0.95

Series	5000 lumen		5500 lumen		6000 lumen	
	120V	277V	120V	277V	120V	277V
Input Voltage 120-277VAC	120V	277V	120V	277V	120V	277V
Input Current (A)	0.419	0.186	0.457	0.201	0.489	0.214
Input Power (W)	50.1	49.5	54.6	53.7	58.4	57.4
In-rush (A)	3.1	15	3.2	14.8	3.4	14.8
Inrush duration (µs)	202	117	196	131	192	121
THD (%)	5.5	7.6	7	7.2	8.1	7.2
PF	≥ 0.99	≥ 0.96	≥ 0.99	≥ 0.96	≥ 0.99	≥ 0.97

Minimum starting temperature -30°C (-22°F)*
(Nominal input 120-277VAC & 100% of rated output power)

Sound Rating: Class A standards

Notes:

* Emergency Battery packs are rated for a minimum starting temperature of 0°C.

Dimensional and Mounting Details

NEW CONSTRUCTIONS - LOW LUMEN 500 – 2500 LUMENS

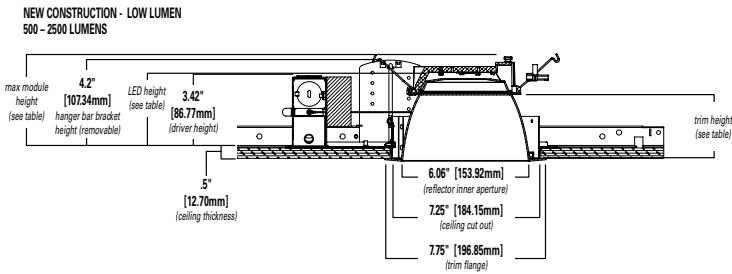

Low Lumen (500 – 2500 Lumens)*

Distribution	Max. Module Height	Trim Height	LED Height
Narrow	4.5"	3.4"	3.8"
Medium	4.6"	3.5"	3.9"
Wide	4.4"	3.3"	3.7"
Baffle	4.4"	3.3"	3.7"



Low Lumen Module

*Max. height w/removable hanger bar bracket 4.2"

NEW CONSTRUCTIONS - MID LUMEN 3000 – 4000 LUMENS

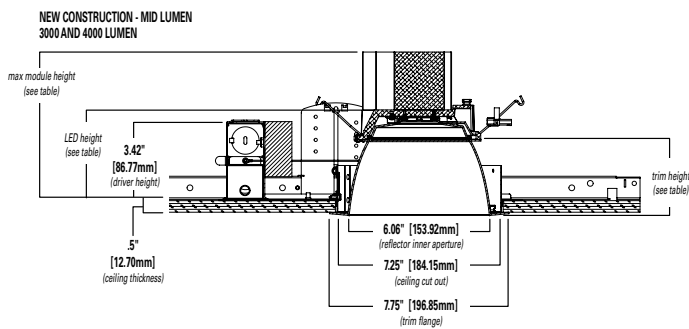

Mid Lumen (3000 – 4000 Lumens)

Distribution	Max. Module Height	Trim Height	LED Height
Narrow	6.6"	3.4"	3.8"
Medium	6.7"	3.5"	3.9"
Wide	6.5"	3.3"	3.7"
Baffle	6.5"	3.3"	3.7"



Mid Lumen Module

NEW CONSTRUCTIONS - HIGH LUMEN 4500 – 6000 LUMENS

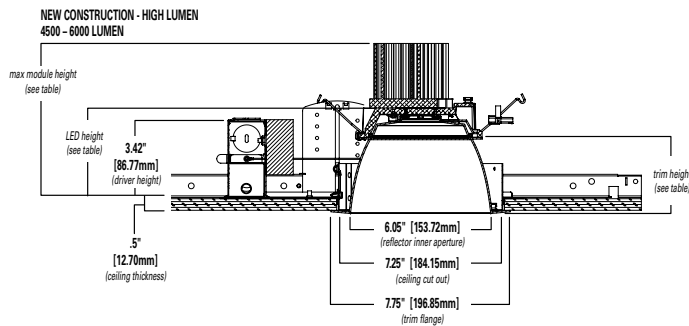

High Lumen (4500 – 6000 Lumens)

Distribution	Max. Module Height	Trim Height	LED Height
Narrow	6.9"	3.4"	3.8"
Medium	7.0"	3.5"	3.9"
Wide	6.8"	3.3"	3.7"
Baffle	6.8"	3.3"	3.7"



High Lumen Module

Connected Solutions

WaveLinx LITE - WTK Tilemount Sensor

WaveLinx LITE devices only compatible with the WaveLinx LITE system.



- Intuitive Android™ or Apple® iOS® app for basic system code compliant set up and configuration via Bluetooth
- Up to 28 unique areas per project site (WaveLinx LITE Bluetooth network)
- Up to 50 devices for an area, any one of 16 control zones, up to 6 occupancy sets, and custom lighting scenes
- Automatic occupancy or vacancy, sensor sensitivity, daylight dimming, etc. configurable through the app
- Refer to the WaveLinx system specifications for details



WaveLinx LITE WTK Tilemount Wiring Diagram

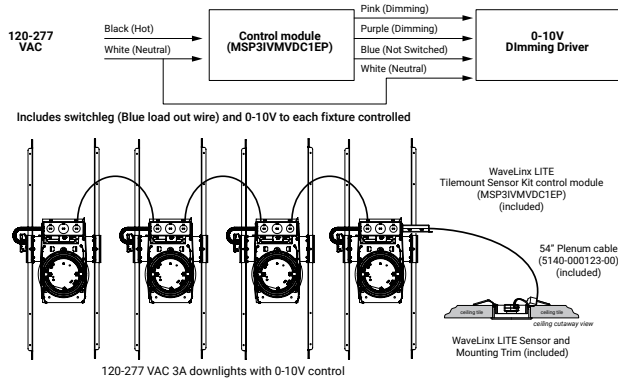

WaveLinx LITE Bluetooth Enabled System



WaveLinx PRO – WTA Tilemount Sensor

WaveLinx PRO devices only compatible with the WaveLinx PRO system.



- WaveLinx PRO tilemount functionality configures zones and customizes settings from one secure mobile app
- Automatic code commissioning that meets the strictest codes
- Fixtures and sensors integrate with Wireless Area Controller, Wall Stations, and Control Devices
- Stand-Along Offices or Entire Building Network Installations

Downlights with tilemount sensor
Highly efficient LED fixtures

WaveLinx Area Controller
Provides centralized coordination of multiple area control options

Wireless Wall Station/Receptacle
Provides customized wireless control of each area

Mobile Applications
Provides personalized, local control from a tablet or smartphone

WaveLinx mobile app settings

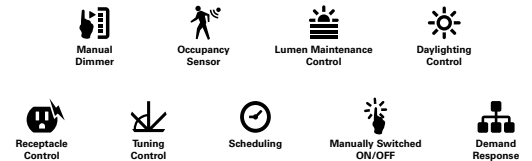

WaveLinx WTA Tilemount Wiring Diagram

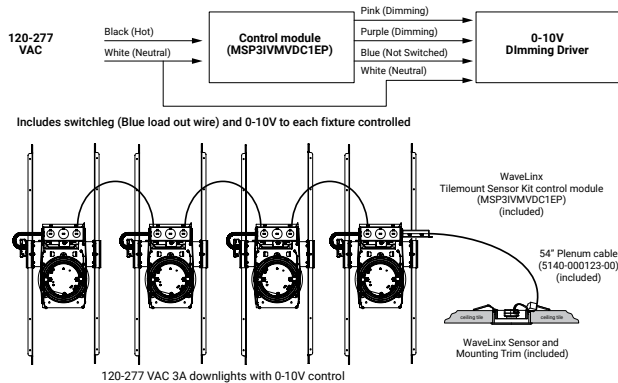

WaveLinx CORE Building Management Integration

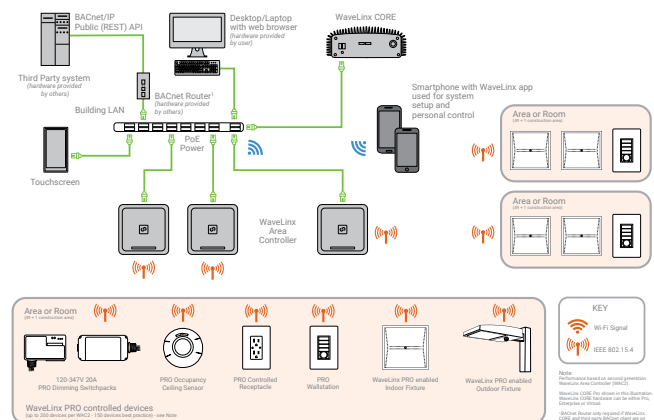

Connected Solutions



WaveLinX LITE Wireless Node - WLN

WaveLinX LITE devices only compatible with the WaveLinX LITE system.

- Intuitive Android™ or Apple® iOS® app for basic system code compliant set up and configuration via Bluetooth
- Up to 28 unique areas per project site (WaveLinX LITE Bluetooth network)
- Up to 50 devices for an area, any one of 16 control zones, up to 6 occupancy sets, and custom lighting scenes
- Refer to the WaveLinX system specifications for details

WaveLinX mobile app settings



WaveLinX LITE Wireless Node (WLN) Wiring Diagram

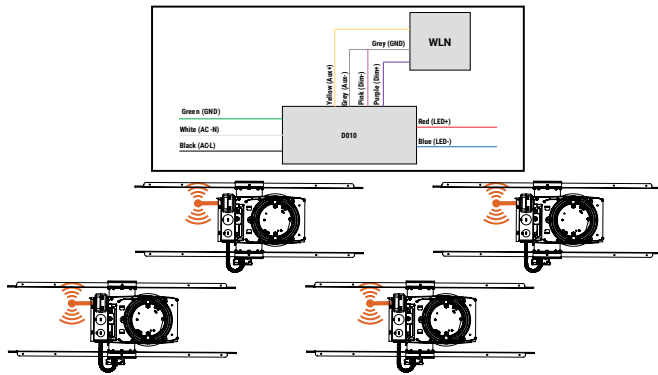

WaveLinX LITE Bluetooth Enabled System



WaveLinX PRO Wireless Node - WPN

WaveLinX PRO devices only compatible with the WaveLinX PRO system.

- WaveLinX Wireless functionality configures zones and customizes settings from one secure mobile app
- Automatic code commissioning that meets the strictest codes
- Fixtures and sensors integrate with WaveLinX Area Controller, Wall Stations, and Control Devices
- Stand-Alone Offices or Entire Building Network Installations



WaveLinX mobile app settings

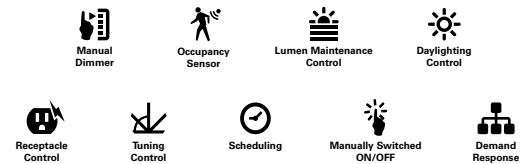

WaveLinX PRO Wireless Node (WPN) Wiring Diagram

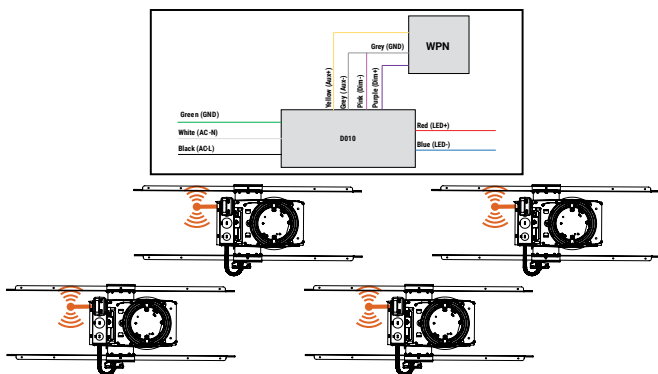

WaveLinX CORE Building Management Integration

