

Project		Catalog #		Type	
Prepared by		Notes		Date	

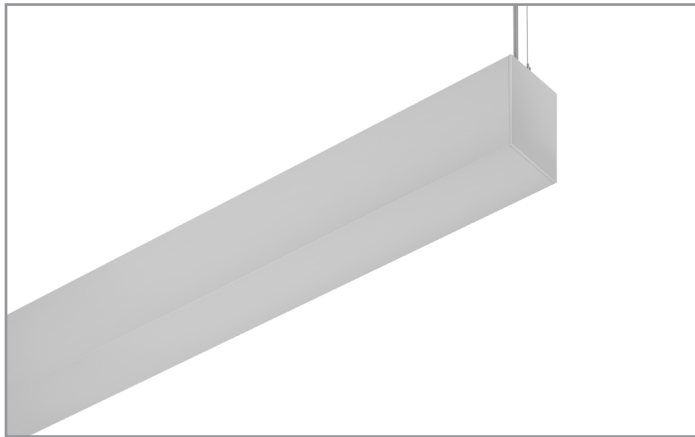

# NeoRay

## Define 5

5" LED  
Suspended Pendant  
Indirect

### Typical Applications

Office • Education • Healthcare • Hospitality • Retail

### Interactive Menu

- Order Information [page 2](#)
- Product Specification [page 3](#)
- Photometric Data [page 4](#)
- Performance Data [page 4](#)
- VividTune [page 6](#)
- BioUp [page 8](#)



### Top Product Features

- Suspended Slot family in 2", 3", 4" and 5" housing sizes
- Specifiable to the nearest foot
- Flush satin lens
- Multiple lumen packages
- 0-10V dimming standard; DALI dimming available
- 2700K, 3000K, 3500K, 4000K, and 5000K correlated color temperatures available
- Available in VividTune and BioUp Technology
- Options to meet Buy American Act requirements

### Dimensional and Mounting Details

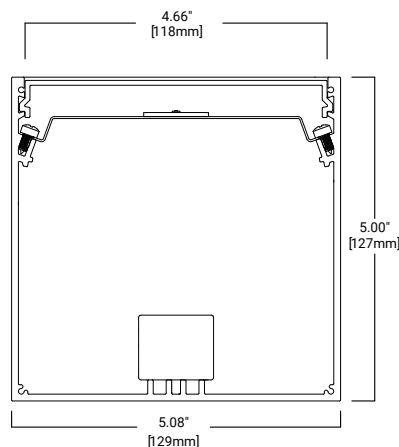

[additional product diagrams](#)

## Order Information

**Icon Key:** ∅ Consult factory for availability

SAMPLE ORDER NUMBER: **S125IP-C365U835-C4JB4F0-1T-UDD-1-W-WPS**

Domestic Preference	Series	Light Engine	Lumen Package UP (Lms/ft)	CRI	LED CCT	Suspension Type	Ceiling Type	Mounting HW Color
<b>[Blank]</b> =Standard <b>BAA</b> =Buy American Act	<b>S125IP</b> =Define 5 Indirect Pendant	-C=Core -H=High Performance -V=VividTune ∅ -B=BioUp	<b>365U</b> =365 Lms/ft (2.2W/ft) <b>590U</b> =590 Lms/ft (3.6W/ft) <b>810U</b> =810 Lms/ft (5.0W/ft) <b>1035U</b> =1035 Lms/ft (6.6W/ft) <b>1205U</b> =1205 Lms/ft (7.9W) ___ <b>U</b> =Custom Lms/ft ∅	<b>8</b> =80 <b>9</b> =90 <b>B</b> =BioUp	<b>27</b> =2700K <b>30</b> =3000K <b>35</b> =3500K <b>40</b> =4000K <b>50</b> =5000K <b>2765</b> =2700K-6500K <b>3050</b> =3000K-5000K <b>2750</b> =2700K-5000K	- <b>C4</b> =4ft Aircraft Cable - <b>C10</b> =10ft Aircraft Cable - <b>C20</b> =20ft Aircraft Cable - <b>S4</b> =4ft Stem Mount - <b>S8</b> =8ft Stem Mount	<b>JB</b> =Gypsum Board, Junction Box, Structure <b>T1</b> =15/16" T-Grid (ETG) <b>T9</b> =9/16" T-Grid (FTG) <b>TS</b> =9/16" Slot (STG), Tegular (FTT), Interlude (ITG)	<b>(blank)</b> =White <b>B</b> =Black
<b>Notes</b> Only product configurations with this designated prefix are built to be compliant with the Buy American Act of 1933 (BAA). Please refer to <a href="#">DOMESTIC PREFERENCES</a> website for more information. Components shipped separately may be separately analyzed under domestic preference requirements.	<b>Notes</b>	<b>Notes</b> See performance table for add'l details. Light engine must be consistent across run length. "V" and "H" light engines not available in 2ft fixture. V option requires lumen package of 810 lms/ft or greater and fixture length of 3 ft+.	<b>Notes</b> 3500K/80CRI/DIP no Lens. Please refer to scaling data for other variables. For custom lumen output, please refer to additional information on page 4. VividTune option requires output >809 lms/ft. 365 Lms/ft and 590 Lms/ft not available on 2ft fixture length. 1205 Lms/ft not valid with DALI or Lutron Drivers. Refer to BioUp Driver Tables on page 7 for light level availability.	<b>Notes</b> Additional lead-time and cost may apply for 927, 930, 935 and 940 configurations. 92765 and 93050 VividTune configurations require V light engine and W2A driver. B35, B40, B50, B2750 BioUp configurations require B light engine. CRI ranges from >80CRI to 96CRI in BioUp Technology and is correlated to Color Temperature.	<b>Notes</b>	<b>Notes</b>	<b>Notes</b> White mounting hardware standard	

Luminaire Length (Ft)	Max section length	Circuiting	Additional Section Wiring	Voltage	Driver Type	Shielding Up
___ <b>F0</b> =Nominal Length	<b>(blank)</b> =12ft (std) /8=8ft	<b>1</b> =Single Circuit <b>S</b> =Secondary Circuit	<b>E</b> =Emergency Circuit <b>B1</b> =7W 120-277V EM battery pack <b>B2</b> =14W 120-277V EM battery pack <b>B3</b> =6W UNV Integral <b>T</b> =UL924 EPC Emergency Bypass Relay	<b>U</b> =Universal (120V-277V) 1=120V 2=277V 3=347V	<b>DD</b> =Standard 0-10V Dimming (1%-100%) <b>5L</b> =Fifth Light DALI (1%-100%) <b>LH</b> =Lutron HiLume (LDE1 series) 1%-100% EcoSys <b>W2A</b> =2-Channel 0-10V (VividTune and Dynamic BioUp Only) <b>W2D</b> =2-Channel DALI (Dynamic BioUp Only)	<b>(blank)</b> =No Lens or N/A <b>1</b> =Satin White Diffuser <b>4</b> =Widespread Batwing Optic
<b>Notes</b> Minimum fixture length is 3ft. Specify to nearest foot in length. Refer to BioUp Driver Tables on page 7 for minimum allowable lengths.	<b>Notes</b> Individual fixtures configured as 12ft max by default. Continuous runs configured as 8ft max (12ft not available).	<b>Notes</b> Secondary circuit similar to A/B switching. Price adder applies for "S" configuration.	<b>Notes</b> Battery available on fixture > 4ft in length. B3 and T options not compatible with 347V. Standard battery 4ft battery section located in the beginning of the fixture, but can be relocated using the linear product configurator. Battery test switch located in knockout on top of fixture. B1 and B2 battery options not available with W2D driver in BioUp Technology	<b>Notes</b> 347V only available with DD and 5L driver options.	<b>Notes</b> Use standard 0-10V (DD) for Static BioUP (B35   B40   B50). 2-Channel 0-10V (W2A) available with VividTune (V) and Dynamic BioUp (B2750) only. 2-Channel DALI (W2D) available with Dynamic BioUp (B2750) only	<b>Notes</b> No lens up standard, use satin white diffuser when dust cover desired on top of the fixture is viewable during normal use. Batwing option requires -C or -B light engine.

Finish	Integrated Sensor
<b>W</b> = White <b>S</b> = Silver <b>B</b> = Black  <b>RR</b> = Real Red <b>OO</b> = Oasis Orange <b>YY</b> = Yippee Yellow <b>GG</b> = Gracious Green <b>CC</b> = Cyprus Cyan <b>TT</b> = Totally Turquoise <b>BB</b> = Biosphere Blue <b>PP</b> = Perfect Purple <b>VV</b> = Vacation Violet <b>MM</b> = Magic Magenta  <b>C</b> = Custom Color (RAL) <b>CM</b> = Custom Color (Match)	<b>[Blank]</b> =None  <b>WaveLinx Wireless</b> - <b>WLS (formerly WAB)</b> = WaveLinx LITE Wireless Sensor, Occupancy w/ photocell, Independent & Networked - <b>WPS (formerly WAA)</b> = WaveLinx PRO Wireless Sensor Occupancy w/ photocell, Networked - <b>WLN</b> = WaveLinx LITE Wireless Control Node, without Sensor - <b>WPN</b> = WaveLinx PRO Wireless Control Node, without Sensor  <b>Other</b> - <b>LWIPD1</b> =Enlighted Integrated Sensor
<b>Notes</b> Custom Colors (C and CM) are available as ETO. Performance is based off White (W) and may vary with selected finish.	<b>Notes</b> All sensor options are available with (DD) driver options only. WPS and WLS sensor options are also available with W2A BioUp Dynamic Option. Refer to Sensor Placement section for additional details. Integrated Sensors are available with Single Circuit (1) option only. Integrated Sensors combined with Emergency Circuit (E) require one UL924 Bypass Relay (T) per emergency fixture. Integrated Sensors combined with a Battery (B) are available with individual Direct/Indirect (DI) luminaires >4ft in length. Integrated Sensor options with Regressed or Drop lenses available as ETO. Tilemount Sensor is recommended.

## Product Specifications

### Construction

- Precision cut housing extruded from 6063 aluminum
- Precision cut & welded end-caps ensure a robust and clean construction
- Nominal 3' -12' illuminated sections used in individual fixtures and 3'-8' illuminated sections used in continuous runs

### Finish

- Electrostatically applied polyester powder coat paint

### LED Module

- Modular LED tray assembly comprising reflector and light engine with quick disconnect wire-harness for ease of installation and maintenance over the life of the luminaire

### Light Engine

- Offered with two next generation Neo-Ray light engines delivering industry leading efficacy and long-life
- LED's are available in 2700K, 3000K, 3500K, 4000K or 5000K
- CRI options of either  $\geq 80$ CRI or  $\geq 90$ CRI (Lumen output will be affected - please refer to the lumen adjustment factor table)

### LED Drivers

- LED system coupled with electrical driver
- Traditional electronic drivers are available for 120-277V and 347V applications

### Controls and Integrated Sensors

- Equipped standard with a 0-10V continuous dimming driver. Compatible with most standard dimming devices
- Additional control types are available (DALI & Lutron) at an additional cost
- WaveLinx and Enlighted wireless sensors as well as stand-alone sensors available

### Mounting

- Suspended

### Lengths

- Available in any length (2ft min) with a resolution of 1 foot. Max section length of 12ft (8ft max used on continuous runs and available for individual fixtures)
- Additional fixture lengths are available please consult factory. All lengths are nominal and do not include end caps.

### Corners and Transition Pieces

- Corners and other transition pieces are fully luminous
- Constructed using precision mitered housing and lens components
- Extrusions are welded to ensure a precise and robust assembly
- Standard 90° horizontal corners as well as custom corners are available
- Consult online linear configurator or the factory for precise corner locations and for ordering
- Alternative transition pieces such as T's, Y's, X's, etc. are also available  $\emptyset$

### Indirect Snap-In lensing Options

- Satin Flush - Flush, high diffusion glare-free lens
- No Lens - No lens option provides the lowest cost solution with the highest efficacy

### Reflectors

- Precision formed cold-rolled steel reflectors with high reflectivity

### Lumen Maintenance

- 90% (L90) of initial light output at 61,000+ hrs
- 70% (L70) of initial light output at 237,000+ hrs
- Derived from TM-21 standard @25°C for worst case operating conditions

### Custom Lumen Output

- Custom lumen output expressed option in Lumens per foot (e.g. -725D for 725 Lms/ft down). Refer to additional detail on page 4.

### Electrical

- Dimming provided as standard
- Dimming wires capped with wire-nuts for non-dimming applications
- Optional battery backup options provided
- Default battery location is internal to fixture
- Default emergency section is 4ft in length and located at the beginning of the fixture unless designated elsewhere
- Estimated lumen output = battery wattage \* min efficacy (see performance table)
- The EPC option will bypass local controls and dimming upon loss of normal power. This option is required when the fixture has both integrated sensors and emergency circuiting

### Integrated Sensors

- Please reference page 5 for details

### Weight

- 4.3 lbs per foot

### Approvals

- cULus - listed for damp locations
- Meets NYC requirements
- Meets CEC requirements
- Tested to IESNA LM-79 and LM-80
- Can be used for State of California Title 24 high efficacy luminaire

### Warranty

- Five year warranty standard.

## Standard Finish Options

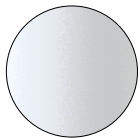

W - White

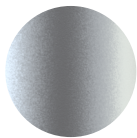

S - Silver

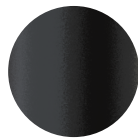

B - Black



RR - Real Red  
RAL 3020  
Gloss



OO - Oasis Orange  
RAL 2004  
Gloss



YY - Yippee Yellow  
RAL 1018  
Gloss

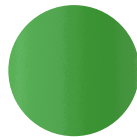

GG - Gracious Green  
RAL 6018  
Gloss



CC - Cyprus Cyan  
RAL 6027  
Gloss



TT - Totally Turquoise  
RAL 5018  
Gloss

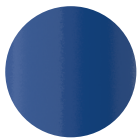

BB - Bioshere Blue  
RAL 5017  
Gloss



PP - Perfect Purple  
RAL 4005  
Gloss



VV - Vacation Violet  
RAL 4008  
Gloss



MM - Magic Magenta  
RAL 4010  
Gloss

RAL & custom colors available as ETO

## Photometric Data - Static White LED Technology

 [View IES files](#)

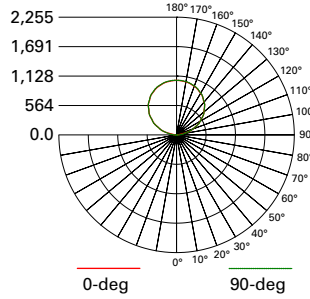

**FILE NAME:**  
**S125IP-S850U835-4F0-1E-UDD**  
**LUMENS:** 6694.0 Lms  
**LPW:** 145.8 LPW  
**CCT:** 3500K  
**WATTS:** 45.9 W  
**TEST NUMBER:** P333223

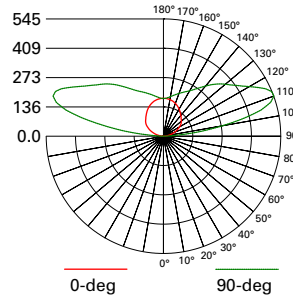

**FILE NAME:**  
**S125IP-S365U835-4F0-1E-UDD-4**  
**LUMENS:** 1317.3 Lms  
**LPW:** 115.6 LPW  
**CCT:** 3500K  
**WATTS:** 11.4 W  
**TEST NUMBER:** P334970

## Photometric Overview and Performance Data

### Indirect Performance Per Linear Foot at 3500K/80CRI

Nominal Output	Standard		High Performance		VividTune	
	W/ft	lm/W	W/ft	lm/W	W/ft	lm/W
365	2.2	168	2.5	171	2.6	164
590	3.6	169	3.9	176	4.3	158
810	5.0	165	5.3	177	5.9	158
1035	6.6	161	7.1	168	7.8	154
1205	7.9	158	8.5	164	9.4	153

### LUMEN ADJUSTMENT CALCULATIONS

#### Example 1 - Adjusted Lumen Output

Nominal Lumen Output selected = 1025 lms/ft (based on standard of 3500K/80CRI)  
 Lumen Adjustment Factor = 0.801 (2700K/90CRI desired)

Adjusted Lumen Output = Nominal Lumen Output x Lumen Adjustment Factor  
 Adjusted Lumen Output = 1025 lms/ft x 0.801 = 821 lms/ft

#### Example 2 - Custom Lumen Output based on Required Lumens Per Foot

Total light output (4ft) requirement of 2800 lms, desired CCT and CRI of 4000K/80CRI

Total required lumens per foot @ 4000K = 2800 lms / 4 ft = 700 lms/ft  
 Lumen Adjustment Factor = 1.018 (Requirement based on 4000K / 80CRI)

Total required lumens per foot @ 3500K / 80CRI = 700 lms/ft ÷ 1.018 = 688 lms/ft

Estimated efficacy = 121 LPW (find nearest value using table above)  
 Estimated power consumption = 688 lms/ft ÷ 121 lm/W = 5.69 W/ft

## Custom Lumen Output

### Total Light Output Range (lms/ft)

CCT	Lumen Adj Factors		Indirect Output Range	
	80CRI	90CRI	80CRI	90CRI
2700K	N/A	0.792	N/A	289-954
3000K	0.943	0.815	344-1136	297-982
3500K	1.000	0.861	365-1205	314-1038
4000K	1.010	0.892	369-1217	326-1075
5000K	1.010	0.892	369-1217	326-1075

If your requirement is expressed in power consumption (W/ft) rather than light output, you can use the power to lumen output curves to convert power consumption to light output for specification. Efficacy for custom lumen outputs can be estimated using lumen output curves or with the use of our online custom lumen output tool.

## Corner Transitions

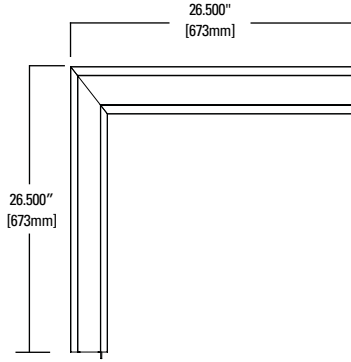

## Integrated Sensor Details and Placement

Sensor Type	Wireless	Sensor Integration	Sensor Mounting	Ordering Code
WaveLinx Pro	Yes	Integral to Fixture	Mounted in solid cover	WAA
WaveLinx Lite	Yes	Integral to Fixture	Mounted in solid cover	WAB
Enlighted	Yes	Integral to Fixture	Mounted in illuminated lens	LWIPD1
Stand-Alone SVPD1	No	Integral to Fixture	Mounted in solid cover	SVPD1

Optional standalone and wireless connected integrated sensors require use of the DD (0-10V) driver. WaveLinx and Enlighted sensors require additional system hardware (not provided) for full functionality.

Standard sensor layout is shown below. Please refer to sensor coverage pattern diagrams to ensure proper coverage for the application. Standard configurations are available in both individual fixtures and in continuous runs. Default spacing is based on the maximum fixture length of 12ft and can be changed to 8ft sensor spacing for additional coverage by selecting the 8ft max fixture length option when ordering.

For additional information integrated sensors and connected lighting, please visit [Cooper Lighting Solutions's Connected Lighting Website](#).

- Standard Sensor with Luminaire Control
- Auxiliary Sensor used for Sensor Coverage (wireless systems only)

### INTEGRAL SENSOR

≤8ft Individual

>8ft Individual

Note: When 8ft max section length is used on individual fixtures > 8ft, sensor placement follows logic for continuous run.

Beginning of Run (BOR)

Intermediate Section (INT)

End of Run (EOR) > 4ft

End of Run (EOR) ≤ 4ft



### Define 5 Pendant LED with VividTune Tunable White

VividTune tunable white luminaires deliver high-quality light in a broad range of continuously variable color temperatures and intensities. Create a dynamic environment by adjusting the ambient light warmer or cooler to influence mood, support the task at hand, or create a dramatic ambience. The ability to control correlated color temperature and intensity separately using simple controls is the next evolution of LED lighting for the commercial, educational, healthcare and hospitality space. The unparalleled flexibility and number of available lighting environments enable users to find the right light with tunable white.

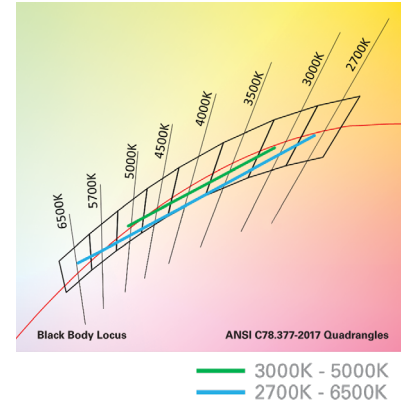

### Performance Data\*

Tunable White - Lumen Adjustment Factors				
CCT	3000K-5000K		2700K-6500K	
	80 CRI	90 CRI	80 CRI	90 CRI
2700K	-	-	0.868	0.741
3000K	0.894	0.736	0.893	0.771
3500K	0.946	0.804	0.924	0.809
4000K	0.993	0.868	0.944	0.835
4500K	1.002	0.883	0.961	0.857
5000K	1.002	0.883	0.974	0.874
6500K	-	-	0.988	0.897

Example of Approximate Lumen Calculation			
	Standard Catalog #	VividTune 80 CRI Catalog #	VividTune 90 CRI Catalog #
CCT Setting	S125IP-C1035U835-X-UDD-W	S125IP-V1035U83050-X-UW2A-W	S125IP-V1035U93050-X-UW2A-W
3000K	-	3701	3047
3500K	4140	3916	3329
4000K	-	4111	3594
4500K	-	4148	3656
5000K	-	4148	3656

### Controlling VividTune Tunable White

VividTune luminaires make tunable white more accessible by using simple and familiar controls. From wall dimmers to wireless controls, VividTune tunable white luminaires are compatible with industry standard 0-10V dimming controls. A single 0-10V dimming input is used to control intensity (brightness) while a second 0-10V dimming input is used to adjust CCT. For suggested control configurations, go to [www.cooperlightingsolutions.com](http://www.cooperlightingsolutions.com) for tunable white application guides.

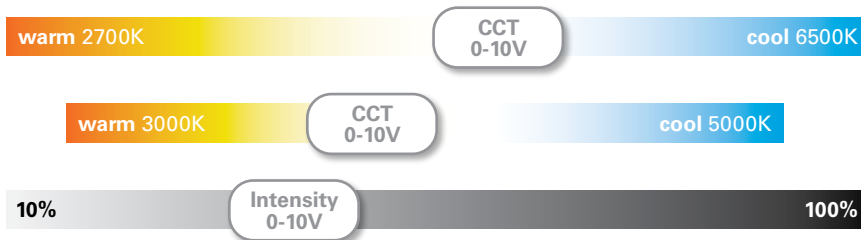

### Example of Lumen Adjustment Calculation

S125IP-V1035U83050-X-UW2A-W at 80 CRI tuned to 3500K

Adjusted Lumen = published lm x adjusted lm factor

Adjusted Lumen = 4140 x 0.946

Adjusted Lumen = 3916 lm

\* Lumen adjustment factors are for reference and may be different for each product selected. Refer to IES files for actual performance data on each.

## BioUp Photometry

**Legend:** • Available  
- Unavailable

5in	INDIRECT SUSPENDED	
Nominal Output	BioUp Light Engine	B35 efficacy
lm/ft	W/ft	lm/W
365	-	-
590	4.5	131.1
810	6.1	132.8
1035	8.3	124.7
1205	9.8	123.0

0-10V						
Availability						
Lumens/ft	365	590	810	1035	1205	
Fixture Length	2	-	-	-	-	-
	3	-	-	•	•	•
	4	-	•	•	•	•
	5	-	•	•	•	•
	6	-	•	•	•	•
	7	-	•	•	•	•
	8	-	•	•	•	•
	9	-	•	•	•	•
	10	-	•	•	•	•
	11	-	•	•	•	•
	12	-	•	•	•	•

DALI						
Availability						
Lumens/ft	365	590	810	1035	1205	
Fixture Length	2	-	•	•	•	-
	3	-	•	•	•	-
	4	-	•	•	•	-
	5	-	•	•	•	-
	6	-	•	•	•	-
	7	-	•	•	•	-
	8	-	•	•	•	-
	9	-	•	•	•	-
	10	-	•	•	•	-
	11	-	•	•	•	-
	12	-	•	•	•	-

# Proven Research. Industry Recognized.

# BioUp

Melanopic Lighting



See better



Feel better



Function better



See [BioUp brochure](#) for more details



**ANSI/IES RP-46-23 / TM18 published March 2024 based on over 40 years of research.**

"...circadian clock synchronization is paramount to the body's efficient and appropriate functioning." – TM18



**BioUp solutions maximize WELL points for Circadian Lighting Design (L03):**

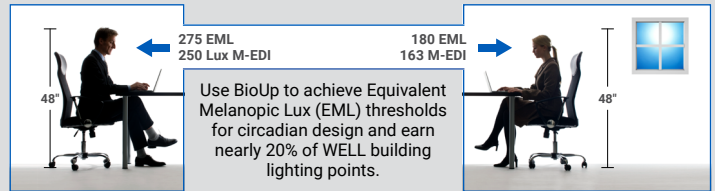

**MDER, M-EDI and EML** are key metrics used to quantify non-visual performance of indoor lighting systems.

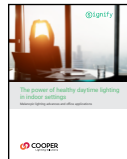

See [BioUp white paper](#) for more details

**MDER** - Melanopic Daylight Efficacy Ratio (MDER) measures the amount of light stimulating to the melanopsin receptors.

**Standard 4000K LED**  
MDER = .62

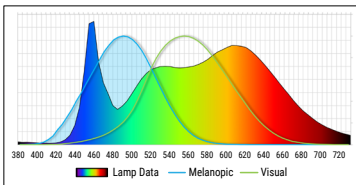

**BioUp 4000K LED**  
MDER = .82

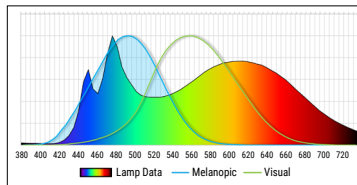

## 30% boost Biological impact compared to traditional LED sources

CCT	LED MDER ~83 CRI	BioUp Static		BioUp Dynamic	
		MDER	CRI	MDER	CRI
2700K	0.44	–	–	0.43	95
3000K	0.49	–	–	0.54	94
3500K	0.56	0.71	90	0.71	90
4000K	0.64	0.84	87	0.82	87
5000K	0.77	0.98	84	0.98	84

BioUp enhances the LED spectrum with cyan light at 475nm increasing the biological impact of the light to enhance our circadian rhythm which regulates our sleep/wake cycle, daytime engagement, and mood – **all without distorting visual color impression.**

### Static (non-tunable)

Static BioUp is used when simple Melanopic Lighting is desired at all times.

Arrow in graph shows BioUp spectrum boost is at 475nm where non-visual biological response is enhanced.

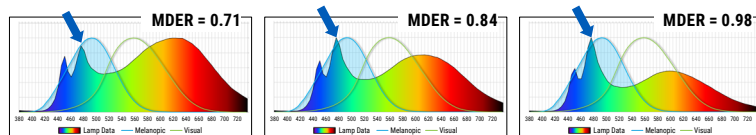

**3500K** or **4000K** or **5000K**

Cyan light component always present



no CCT control needed

### Dynamic - (Tunable)

Dynamic BioUp is used when Melanopic Lighting is desired to adjust during the day.

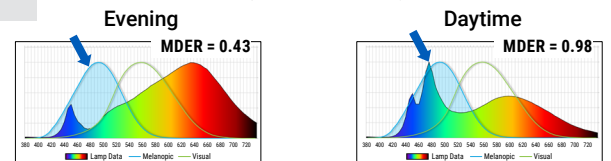

Warmer CCT Without Cyan content ← → Cooler Light With Cyan content

**2700K – 5000K**



Control with Wavelinx, 2ch 0-10V, or DALI