

Project		Catalog #		Type	
Prepared by		Notes		Date	



# Fail-Safe

## HVSL2 | HVSL2-SQ

Vandal Resistant / High Abuse  
2" Nominal Width, Surface Mount  
Frosted Polycarbonate Lens

### Typical Applications

Stairwells • Schools • Hospitals • Corridors • Dormitories • Public restrooms • Common areas • Transit stations

### Interactive Menu

- Order Information [page 2](#)
- Product Specifications [page 3](#)
- Nominal Input Watts/Delivered Lumens [page 3](#)
- Product Warranty

### Top Product Features

- Narrow 2.5" width for use when space is limited
- High impact polycarbonate lens
- Damp location standard, wet location optional
- Available in a variety of paint finishes
- Up to 4100 lumens in 4ft length
- Efficacy up to 106 lm/W
- Options to meet Buy American Act requirements
- **10-Day Quick Spec available**

### Product Certification



### Product Features



**16 Architectural Colors**  
See page 2 for details

### Dimensional and Mounting Details

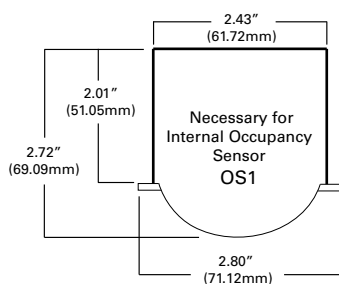

HVSL2-SQ

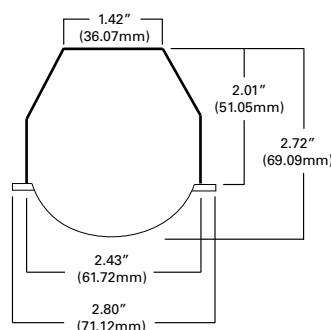

HVSL2

[additional product diagrams](#)

## Order Information

SAMPLE NUMBER: HVSL2-4-LD4-STD-40-UNV-O-EDC1

SAMPLE NUMBER: HVSL2-SQ-4-LD4-HI-40-277-O-EDC1-OS1

10-DAY QUICK SPEC SAMPLE NUMBER: QS-HVSL2-2-LD4-STD-35-UNV-O-EDC1

Gray bar denotes available with 10-Day Quick Spec

Domestic Preferences <sup>(1)</sup>	Product Family	Length	LED Type	Illumination Level	Color Temperature	Voltage	Lens Type
<b>[Blank]</b> =Standard <b>BAA</b> =Buy American Act	<b>HVSL2</b> =2" Wide HVSL Linear Steel <b>QS-HVSL2</b> =2" Wide HVSL Linear Steel, Quick Spec <sup>(2)</sup> <b>HVSL2-SQ</b> =2" Wide HVSL Linear Steel, straight side, (required for OS1 option)	<b>2</b> =2' Length <sup>(4)</sup> <b>3</b> =3' Length <b>4</b> =4' Length <b>8</b> =8' Length <sup>(3)</sup>	<b>LD4</b> =LED, Version 4.0	<b>LO</b> =Low <b>STD</b> =Standard <b>HI</b> =High	<b>30</b> =3000K Kelvin <b>35</b> =3500K Kelvin <b>40</b> =4000K Kelvin <b>50</b> =5000K Kelvin	<b>UNV</b> =120/277	<b>O</b> =Opal Polycarbonate
<b>Notes</b> (1) Only product configurations with this designated prefix are built to be compliant with the Buy American Act of 1933 (BAA). Please refer to <a href="#">DOMESTIC PREFERENCES</a> website for more information. Components shipped separately may be separately analyzed under domestic preference requirements.	(2) 10 day ship, from date of receipt of clean PO to ship date. 25 unit maximum per PO. QS option is only available with the shaded options. EL10W along with QS option is only available in 4' length.	(3) 8ft. unit consists of two (2) 4ft. housings joined together at the factory with single 8 ft. lens. (4) No center KO.					

Driver	Options	Finish	Accessories (Order Separately) <sup>(12)</sup>
<b>EDC1</b> =Single Circuit, Non-Dimming <b>EDD1</b> =Single Circuit, 0-10V 10% Dimming <sup>(5)</sup> <b>ED1D1</b> =Single Circuit, 0-10V 1% Dimming <sup>(5)</sup>	<b>EL10W</b> =10W Emergency Pack <sup>(6)</sup> <b>SF1</b> =TORX® T20 Tamper Proof side screws <b>SF3</b> =Allen-head center pin reject Tamper Proof side screws <b>SHP</b> =Stainless Steel Painted Housing <b>SHPA</b> =Stainless Steel Painted, all Fabricated Components <b>ALH</b> =Aluminum Painted Housing <b>ALHA</b> =Aluminum Painted, all Fabricated Components <b>GSKLNS</b> =Gasket to Lens - Side and Ends <sup>(8)</sup> <b>WL</b> =Wet Location Under Covered Ceiling <b>PMSC</b> =Pendant Mount, Stem/Canopy using standard knockouts in back of housing, (3', 4' & 8' length only) - damp location rated only, (no wet location) <sup>(7)</sup> <b>PMY</b> =Pendant Mount, AYC Chain or Y-Toggle, uses (4) 0.187" x 0.937" holes, (2) each end, (3', 4' & 8' length only) - damp location rated only, (no wet location) <sup>(7)</sup> <b>AM</b> =Anti-microbial matte white paint <b>FSS</b> =Flush side screws (secure lens, non tamper proof) <b>FSSTP</b> =Flush side screws (secure lens, tamper proof)	<b>Standard Colors</b> <b>[Blank]</b> =Matte White <b>AM</b> =Antimicrobial Matte White <b>GW</b> =Gloss White <b>DP</b> =Dark Platinum, Satin Finish <b>BK</b> =Black, Satin Finish <b>BZ</b> =Bronze <b>Architectural Colors</b> <b>TCB</b> =Terra Cotta Brick <b>MRR</b> =Merlot Red <b>PMK</b> =Pumpkin <b>GLD</b> =Goldenrod <b>SGG</b> =Sage Green <b>EVG</b> =Evergreen <b>CBL</b> =Coastal Blue <b>NTB</b> =Night Blue <b>UMB</b> =Ultramarine Blue <b>PPV</b> =Purple Violet <b>NTN</b> =Neutral Tan <b>DBG</b> =Dark Beige <b>CRM</b> =Cream <b>SLG</b> =Silver Grey <b>OLG</b> =Olive Green <b>MHB</b> =Mahogany Brown <b>RALxxxx</b> =RAL Number Color <sup>(9)</sup>	<b>VRSD</b> =T20 Center Pin Tamperproof TORX®-head bit <b>SCF-XX-B</b> =Fixed Stem Set (see ordering information page 4) XX=Length (6, 8, 12, 24, 36, 48, 60, 72) Used with all surface fixtures as stem sets. One set consists of one stem assembly. Minimum of two sets required per fixture. Not rated WL under covered ceiling. <b>HVSL2-X-CM/BKT</b> =HVSL2 Corner Mount bracket, specify length (X=length=2, 3, 4, 8) <sup>(10)</sup> <b>HVSL2-X-WMAB45</b> =Wall Mount angle bracket, 45 degree, specify length (X=length=2, 3, 4, 8) <sup>(10)</sup> <b>HVSL2-CRNR/CONN</b> =Corner Connector, 90 degree. (not applicable to HVSL2-SQ) <sup>(10)</sup> <b>HVSL2-SQ-X-CM/BKT</b> =HVSL2 Corner Mount bracket, specify length (X=length=2, 3, 4, 8) <sup>(11)</sup> <b>HVSL2-SQ-X-WMAB45</b> =Wall Mount angle bracket, 45 degree, specify length (X=length=2, 3, 4, 8) <sup>(11)</sup>
<b>Notes</b> (5) Purple and gray low voltage driver leads connected to driver for EDD1, ED1D1. Not connected for EDC1.	<b>Notes</b> (6) Emergency not available in 2ft, or 3ft lengths. (7) Does not include stem, chain, or y-toggle (see page 6 for order information). (8) GSKLNS option is standard with WL option not necessary in catalog.	<b>Notes</b> (9) Replace XXXX with unique 4 digit RAL number. Please contact Fail-Safe Tech for a list of additional finish swatches.	<b>Notes</b> (10) Compatible with HVSL2 (reference option/accessory page for bracket dimensions). (11) Compatible with HVSL2-SQ (reference option/accessory page for bracket dimensions). (12) Accessories sold separately will be separately analyzed under domestic preference requirements. Consult factory for further information.

## Fail-Safe Standard Colors



## Fail-Safe Architectural Colors



## Product Specifications

### Housing

- Heavy duty, 18 ga. steel housing and end caps provide rigid construction
- Stainless-steel and die-formed aluminum available
- End caps provided with 7/8" KO for continuous row mounting
- Pendant mount standard with (2) 7/8" KOs in the housing back (all lengths except 2'). Stem sets ordered seperately as accessory item
- Finished in matte white paint standard. Optional architectural colors available
- Electrostatically applied, matte white powder coat finish; gloss white, silver, black, bronze, dark platinum available; Custom colors available (supply RAL number, paint chips, or paint manufacturer catalog number). 16 architectural colors available.

### Fasteners

- White painted Hex-head screws (4) secure the lens to the housing
- Stainless steel TORX®T20 (SF1) with center reject pin and allen head with center pin reject screws (SF3) optional
- Optional flush side screws (FSS or FSSTP) painted matte white

### Lens

- One-piece extruded UV stabilized, diffuse polycarbonate
- Unique linear ribbed design provides even light distribution while obscuring LED boards
- Internal ribs and smooth exterior reduce dirt build-up and facilitates cleaning.
- Nominal lens thickness = 0.085"

### Reflector

- 18 ga. Steel with white high reflectance polyester powder coat finish. Reflector serves as driver and wireway cover.
- Reflector serves as driver and wireway cover

### Mounting

- Surface mount standard, wall or ceiling.
- Continuous row using end knock-outs

### Light-Emitting Diode (LED)

- LEDs available in 3000K, 3500K, 4000K and 5000K with minimum 80 CRI.

### Transformer/Driver

- Electronic driver. 0-10V dimming standard
- Optional 10% and 1% dimming

### Compliance

- cULus listed for damp locations standard
- Wet location under covered ceiling optional, wall or ceiling mount

### Warranty

- Five-year warranty on LEDs and electrical
- Fail-Safe will repair or replace any vandal resistant / high abuse luminaire, that is deemed non-functional due to physical damage to the luminaire exterior housing or polycarbonate lens. The luminaire must be installed correctly, and the warranty does not include any interior component, nor does it include damage due to gunfire, paint, caustic material / chemicals, disastrous or abnormal events.

## Nominal Input Watts/Delivered Lumens - 4000K

 [View IES files](#)

Fixture	Length	Illumination Level	Nominal Input Watts	Opal Lens	
				Nominal Delivered Lumens	LPW
HVSL2 (4000K)	2'	LO	11.5	1301	113.2
		STD	16.4	1676	102.2
		HI	21.6	2157	99.9
	3'	LO	17.3	1952	112.8
		STD	24.6	2514	102.2
		HI	32.4	3235	99.8
	4'	LO	23.1	2602	112.6
		STD	32.7	3351	102.5
		HI	43.1	4312	100.1
	8'	LO	46.7	5203	111.4
		STD	66.1	6703	101.4
		HI	87.2	8625	98.9

\* Nominal input wattage values include LED voltage, drive currents and typical driver efficiency. Refer to LM79 data/photometric files for exact delivered lumen values and input wattage. Values in table are nominal values only.

### Lumen Calculator

Approximate CCT Multiplier	
3000K	0.98
3500K	1.00
4000K	1.00
5000K	1.01

## Dimensional and Mounting Details

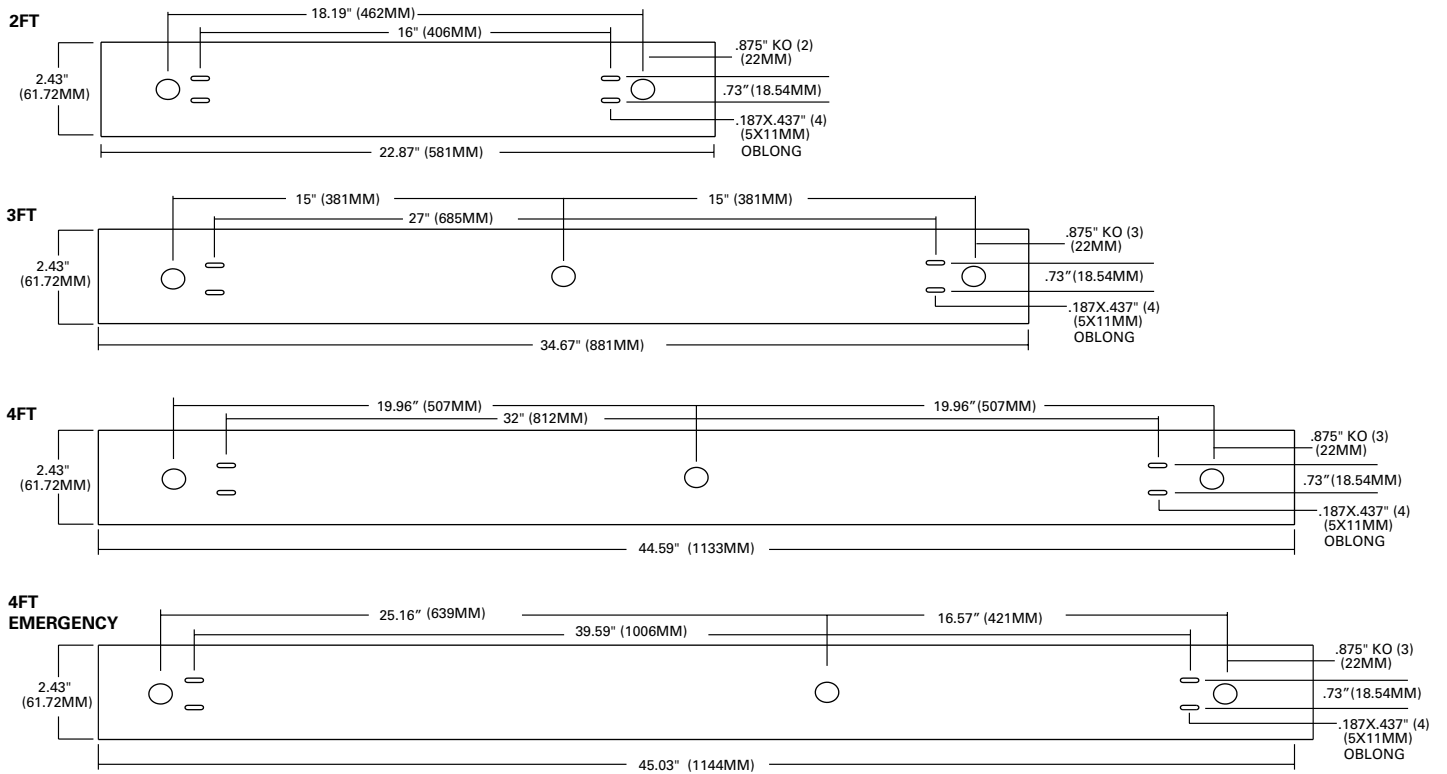

**NOTE:**

\* 8' Fixture incorporates (2) 4' fixtures, attached at the factory, and one single 8' length lens

### Corner Mount Bracket (Accessory)

HVSL2-X-CM/BKT=HVSL2 Corner Mount Bracket, specify length,(X=2, 3, 4,8)

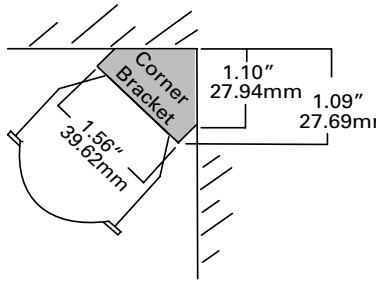

### Wall Mount Angle Bracket (Accessory)

HVSL2-X-WMAB45=HVSL2 Wall Mount Angle Bracket, 45 degree, specify length, (X=2, 3, 4,8)

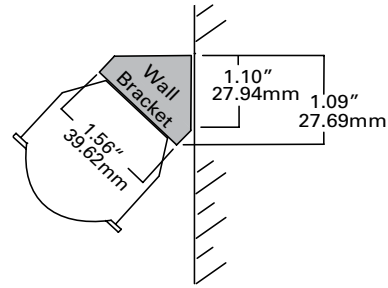

HVSL2-SQ-X-CM/BKT=HVSL2-SQ Corner Mount Bracket, specify length, (X=2,3,4,8)

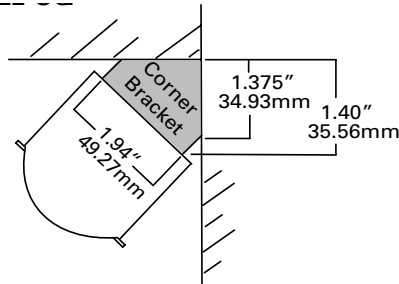

HVSL2-SQ-X-WMAB45=HVSL2-SQ Wall Mount Angle Bracket, 45 degree, specify length, (X=2,3,4,8)

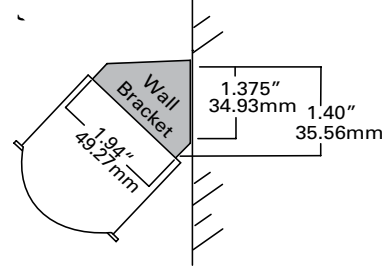

### HVSL2 - Corner Connector (Accessory)

HVSL2-CRNR/CONN=HVSL2 Corner Connector, 90 degree.

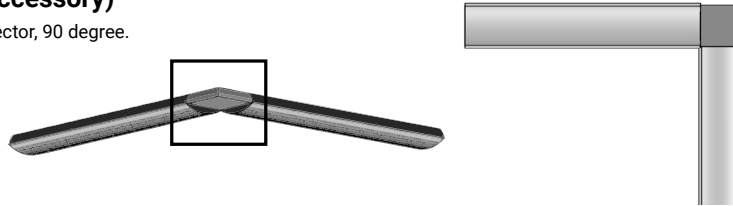

### Pendant Mount: Suspension Sets - Stem Sets (Option)

XX=Length (6, 8, 12, 24, 36, 48, 60, 72)

SCF-XX-B=Fixed Stem Set

Used with all surface fixtures as stem sets. One set consists of one stem assembly. Minimum of two sets required per fixture. Not rated WL under covered ceiling.

**NOTE:** Coupler, 3/8" IPS Pipe Coupler to join lengths. Coupler is standard baked white enamel or special order of black. Must specify pendant mount (PMSC or PMY) option on luminaire.

### Decorative Lens/Bands (Option)

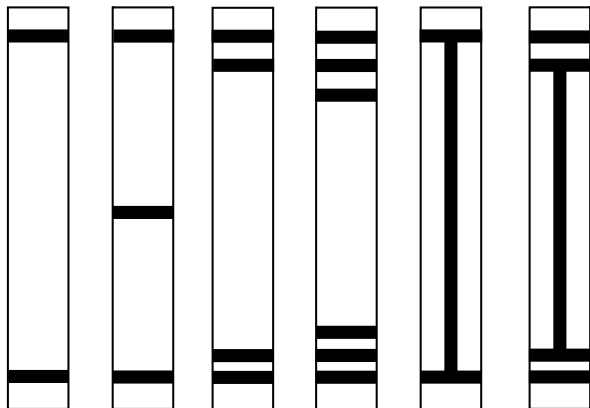

1E/BK 1E/1M/BK 2E/BK 3E/BK 1E/1V/BK 2E/1V/BK

### Ordering Logic (Add to end of fixture catalog #)

Examples: HVSL2-4-LD4-1STD-40-UNV-0-EDC1-1E/BK

No of Horizontal band and Location	Vertical Band	Band Color
1E=1 Band on End 2E=2 Bands on End 3E=3 Bands on End	1V=1 Band Vertical	BK=Black BR=Bronze BL=Blue
1M=1 Band in Middle 2M=2 Bands in Middle 3M=3 Bands in Middle		

**Notes:**

- \*Bands are 1/2" thick
- \*Bands are high durability paint finish
- \*For custom colors, please furnish RAL# or paint manufacturer/catalog number
- \*For other variations or colors not shown, please issue PDR