

Project		Catalog #		Type	
Prepared by		Notes		Date	



WaveLinx

PRO Industrial Fixture Mount High Bay/Low Bay Sensor (WPS*)

Motion and Closed Loop Daylighting including Field Installed Aisle Shield

Typical Applications
Industrial • Manufacturing

Interactive Menu

- Order Information page 2
- Additional Resources page 3
- Connected Systems page 5
- Product Warranty



- Meets latest ASHRAE Standard 90.1 requirements
- Meets latest IECC requirements
- Meets latest CEC Title 24 requirements

Product Features



Compatibility



Overview

The PRO Industrial Fixture Mount High Bay / Low Bay Sensor offers passive infrared (PIR) occupancy and a photocell for closed loop daylighting. WaveLinx PRO industrial sensors offer installation heights up to 40 feet and have coverage patterns up to 5000 square feet (see sensor specifications - field of view). When part of WaveLinx PRO, the sensor operates on a wireless mesh network based on IEEE 802.15.4 standards.

The sensors offer simple tool-less integration into WaveLinx PRO industrial light fixtures equipped with the 4-pin Zhaga Book 18 compliant socket. Once installed, sensors receive power from their co-located light fixture with no batteries to replace. The sensor in combination with the WaveLinx Mobile application allows you to gain considerable energy savings from occupancy and daylight sensing lighting control. The WaveLinx Mobile application allows you to map the sensor to any area or control zone, select occupancy or vacancy, occupied and unoccupied light levels and set the hold time.

Product Features & Benefits

- Models suitable for High bay (up to 40ft / 45ft major motion) and Low bay (up to 15ft) applications
- Out of the box functionality: Occupied to Full, Unoccupied to 10%, daylighting disabled
- Passive Infra-Red (PIR) motion sensor with coverage up to 5000 square feet
- Integrated photocell for closed loop daylight harvesting
- Software configurable settings with WaveLinx Mobile application
- Simple tool-less twist lock fixture connection via 4-pin Zhaga Book 18 socket
- IP66 rating for warehouse and manufacturing environments
- Energy calculations available through WaveLinx CORE

Order Information

WaveLinx PRO Industrial Fixture Mount High Bay / Low Bay Sensors are accessories to the WaveLinx connected lighting system and requires a WaveLinx Area Controller (WAC) for full functionality.

WaveLinx PRO Industrial Fixture Mount High Bay / Low Bay Sensors are used to provide occupancy and daylight dimming to spaces from the industrial light fixture. For energy code compliance, additional sensors may not be required.

Catalog Number

Catalog #	Description
WPS2-WH	WaveLinx PRO Industrial Fixture Mount Low Bay Sensor, White, 7 - 15ft (2.1 - 4.5m)
WPS4-WH	WaveLinx PRO Industrial Fixture Mount High Bay Sensor, White, 15 - 40ft (4.5 - 12.2m)
Notes	Notes
For use with industrial light fixtures equipped with the WaveLinx PRO Zhaga compliant 4-pin socket only.	When used as a component in the WaveLinx connected lighting system, WaveLinx PRO system design best practices (including WaveLinx Area Controller placement, line of sight distances, number of hops, etc.) must be followed. High mount models accommodate mounting height to 45ft (13.7m) for major motion (vehicles, fork trucks, etc.) - may not detect minor motion of people depending on conditions.

Required Accessories

All WaveLinx connected lighting system accessories require at least one WaveLinx Area Controller (WAC2) for communications. Ensure the bill of material includes one of the following components.

Catalog Number

Catalog Number	Description
WAC2-POE	WaveLinx Area Controller G2, PoE powered
WAC2-120	WaveLinx Area Controller G2 with 120VAC to PoE Injector

Optional Accessories

For connection to 120VAC outlets.

Catalog Number

Catalog Number	Description
WPOE2-120	120VAC to PoE Injector

Product Specifications

Mechanical

Size: Base Diameter 3.2" (82mm) Height: 1.6" (41mm)

Weight: 0.20 lbs (0.10 kg)

Environment:

- **Operating temperature:** -40°F to 131°F (-40°C to 55°C)
Sensor passive infrared (PIR) performance may become exceedingly sensitive below -4°F (-20°C)
Note: WaveLinx Area Controller should be installed in an indoor conditioned environment, preferably with line of sight through a window to one or more WaveLinx PRO wireless devices.
- **Storage temperature:** -40°F to 158°F (-40°C to 70°C)
- Default behavior intended for indoor use only

Mounting: Fixture mount

Mounting Height: High bay up to 40ft (12m) and Low bay up to 15ft (5m)

Color: White

Housing: UV stabilized plastic

Ingress protection: IP66

Light Sensor Detector Shields: Field configured shield included

Daylighting Installation:

- Ensure that sensor is not looking directly at artificial light
- Ensure that sensor is not obstructed
- Use configurable lens mask for desired directionality

Electrical

Input Requirements: Fixture connection via 4-pin Zhaga Book 18 socket

Software Specifications

- Any number of sensors can be mapped to any number of zones
- Mobile app configuration for Occupancy/Vacancy
- Remote Hold Time settings fully configurable via mobile app
- Mobile app configuration of Occupied and Unoccupied light levels
- Energy calculations available through WaveLinx CORE

Wireless Specifications

Radio: 2.4GHz

Standard: IEEE 802.15.4

Transmitter Power: + 8dBm

Range: Sensor to sensor; 160ft (49m) LOS (best practice)

System Performance

Maximum number of nodes supported: 200 per WaveLinx Area Controller (best practice 150 devices)

Standards/Ratings*

- cULus Listed - Energy Management Equipment (UL916)
- FCC Part 15/ECES-003
- Meets latest ASHRAE Standard 90.1 requirements
- Meets latest IECC requirements
- Meets latest CEC Title 24 requirements

Warranty

Five year warranty standard



Download the WaveLinx Mobile App from either the Google Play or Apple Store®

Dimensional Details

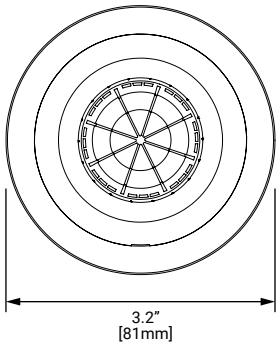

TOP

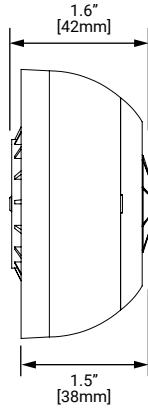

SIDE

Mounting Height

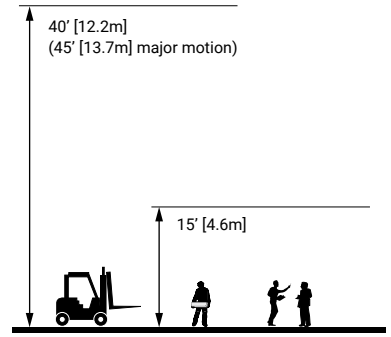

Installation

Both the WPS2 and WPS4 easily install into WaveLinx PRO-ready LED fixtures equipped with Zhaga Book 18 4-pin sockets. Sensor connection is enabled via the simply twist-lock connection and provides immediate out-of-the-box functionality.

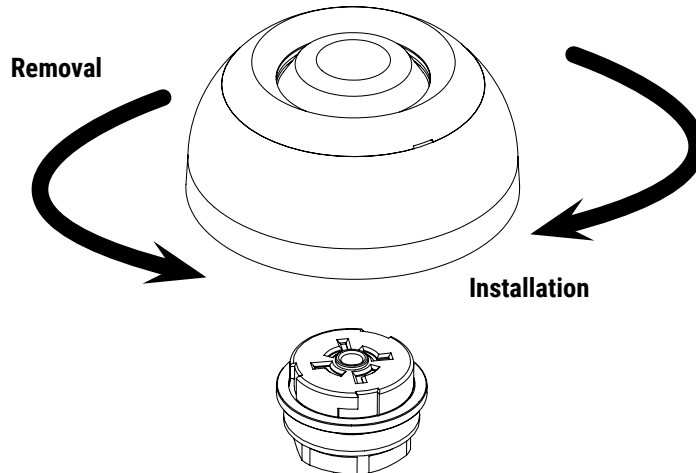

Field of View - Low Bay

TOP VIEW:

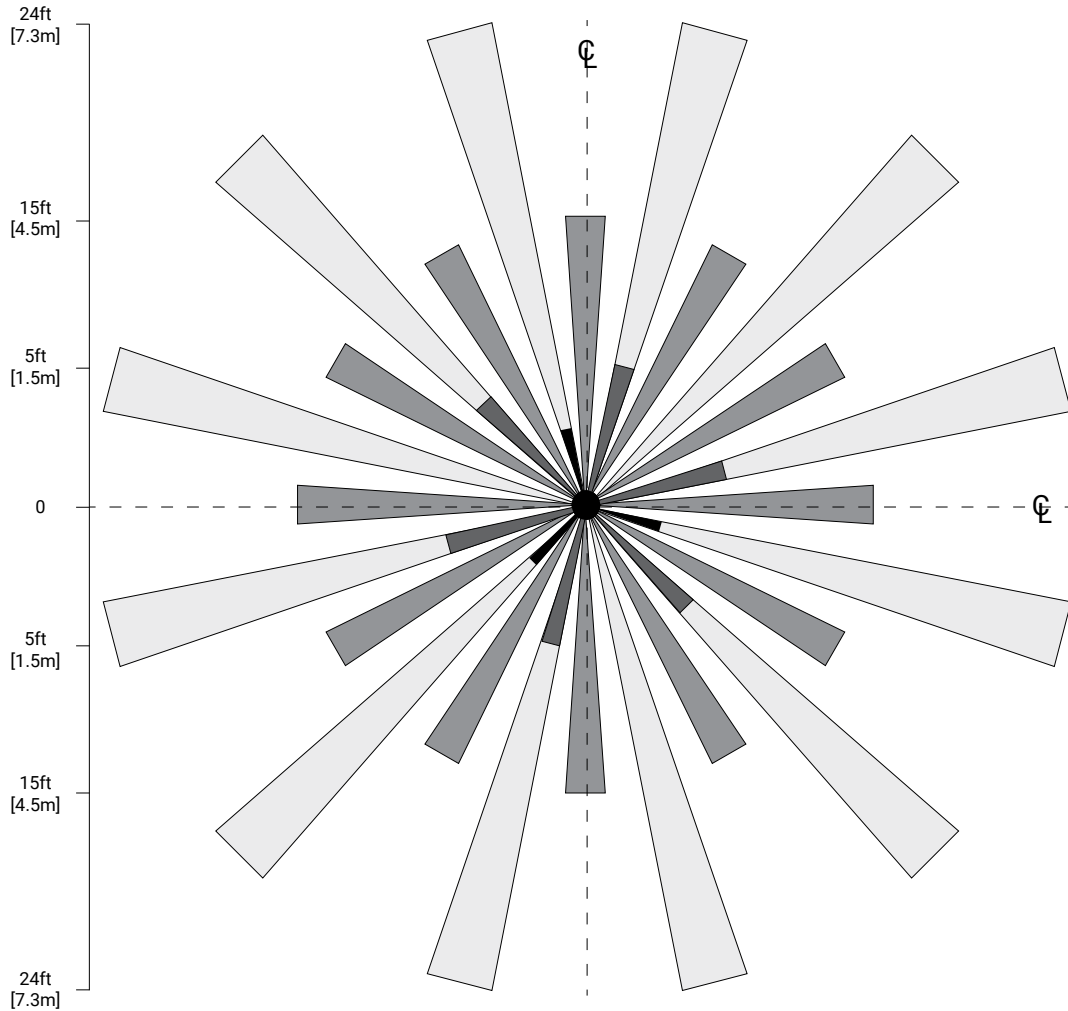

Note: The "beam" pattern obtained depends strongly on the detector used with this array. The pattern shown is intended solely as a general guide and is not to scale.

SIDE VIEW:

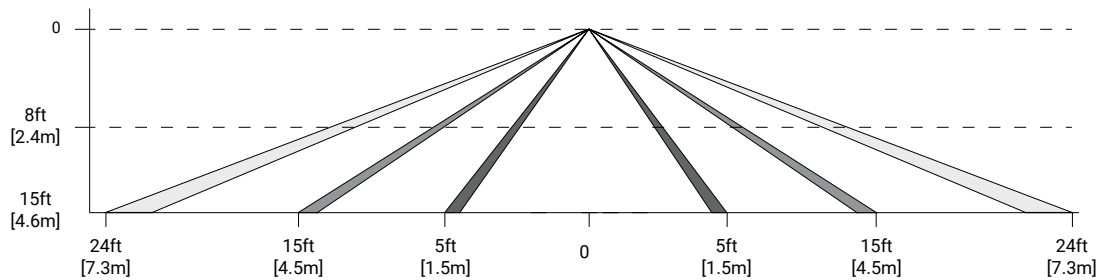

Field of View - High Bay

TOP VIEW:

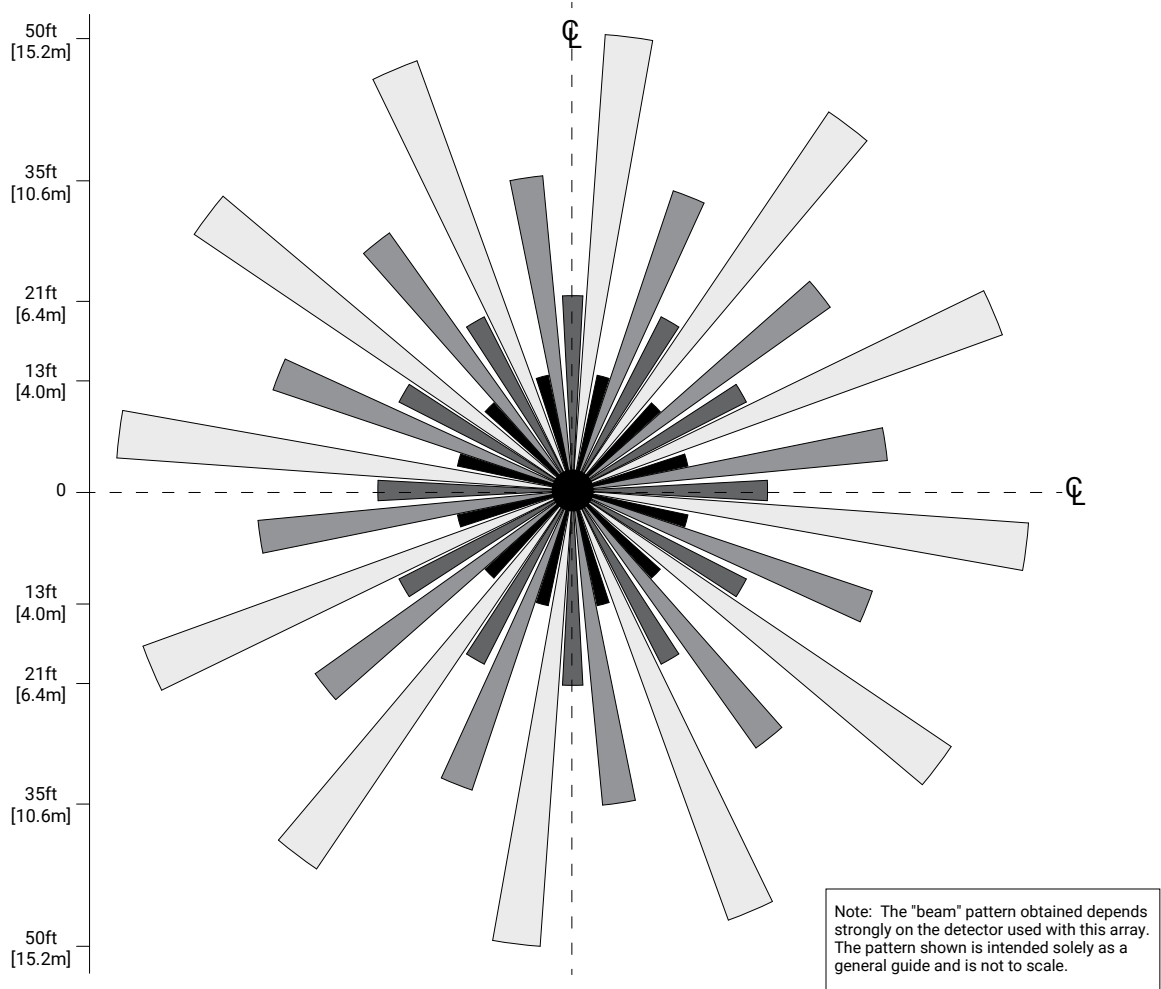

SIDE VIEW:

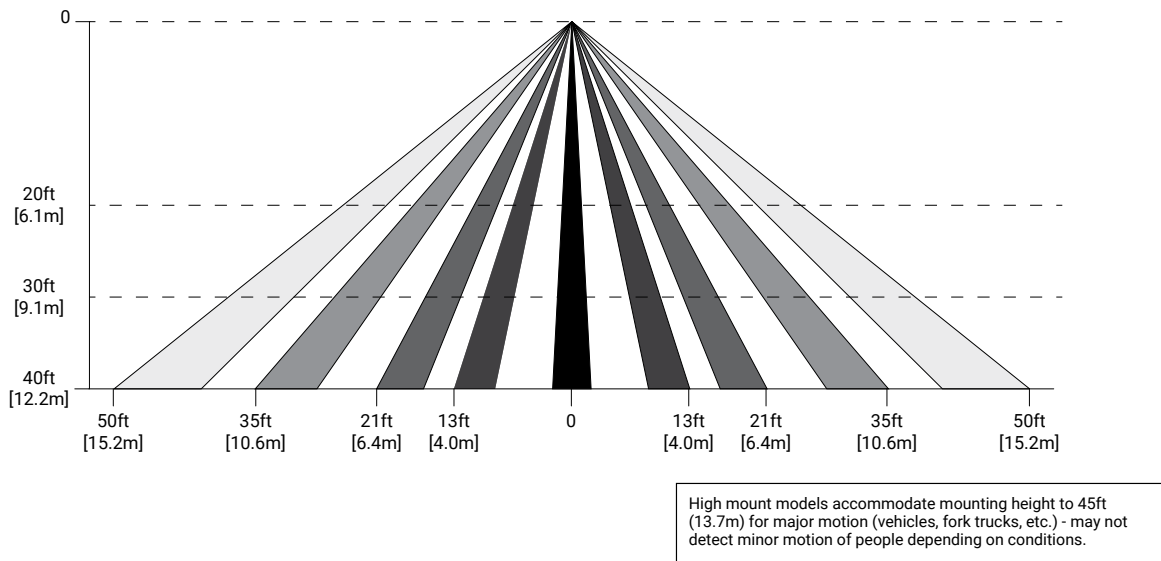

System Diagram:

This diagram shows the main components of the WaveLinx connected lighting system with WaveLinx DALI, CAT and PRO devices. The PRO devices communicate using wireless mesh technology based on the IEEE 802.15.4 standard. A PoE LAN connection for each WaveLinx Area Controller (WAC) is required for power and data access to the building lighting network. The CAT devices communicate over the category 5 based communication bus and control the light fixtures using a relay (on/off) and 0-10V output (dim/raise). WaveLinx DALI devices communicate via a DALI bus (2 wires), which connects various components including DALI fixtures, a DALI DAC (DALI to 0-10V converter), DALI field relays, DALI wallstations, and DALI occupancy sensors. WaveLinx Area Controllers (WAC) communicate with WaveLinx CORE Apps over the Ethernet network.

[View WaveLinx Network and IT Guidance Technical Guide](#)

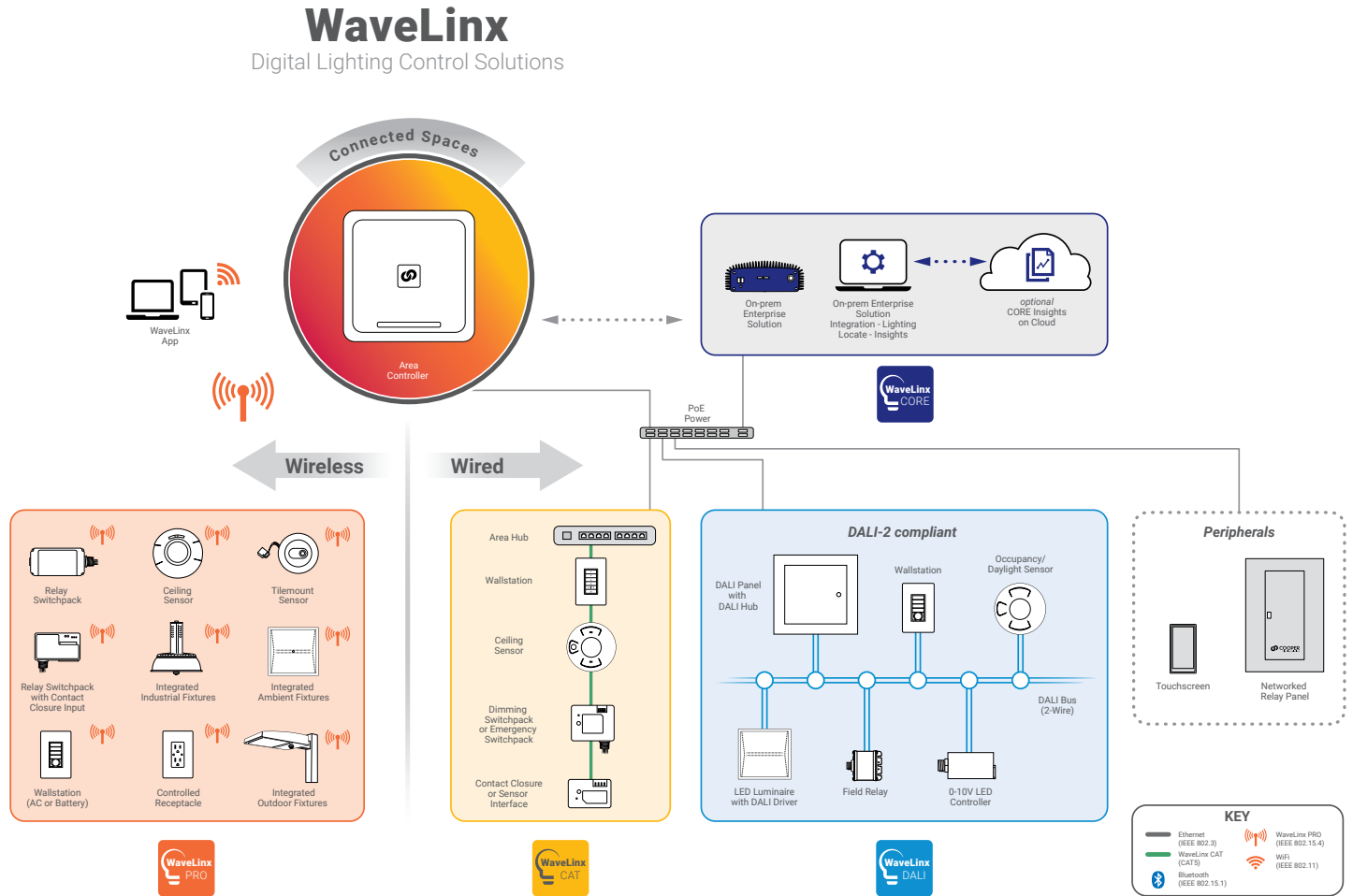

Control Systems
• WaveLinx