

Project		Catalog #		Type	
Prepared by		Notes		Date	

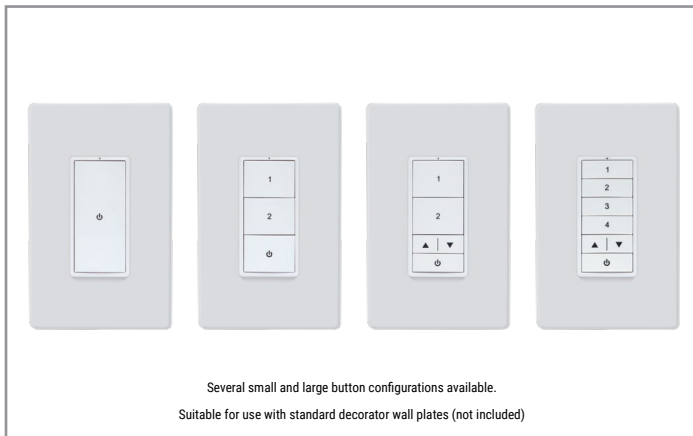

WaveLinX PRO Wallstation (WW-Series)

A wireless 120/277VAC powered wallstation with configurable button options including toggle, on/off, raise lower and presets scenes

Typical Applications

Office • Education • Healthcare • Hospitality • Retail
Industrial • Manufacturing

Interactive Menu

- Order Information page 2
- Button Options page 2
- Additional Resources page 3
- Product Warranty

Product Certification*



- Meets latest ASHRAE Standard 90.1 requirements
- Meets latest IECC requirements
- Meets latest CEC Title 24 requirements

Product Features



Compatibility



Overview

The PRO WW-Series Wallstation is a wireless, 120/277 VAC powered wallstation with configurable buttons including toggle, on/off, raise lower, and preset scenes. Each button's actions are configurable using the WaveLinX Mobile App.

The PRO WW Wallstation's elegant design enhances the aesthetic of a space while allowing occupants to adjust the room's brightness levels based on their sensitivity and needs.

Product Features & Benefits

- **Configurable button options** – Power toggle (on/off), raise/lower, multi-scene selection
- **Single LED Indicator** – Indicates the status of the wallstation
- **120/277VAC powered (neutral required)** – No battery replacement required
- **Button actions configurable via software** – Customize the actions of each button using WaveLinX Mobile Application or WaveLinX Core Lighting App

*T24 and RoHS are self-tested by Cooper Lighting Solutions. Not a third party certification.

Order Information

The WaveLinx PRO WW-Series Wallstation is an accessory to the WaveLinx system and requires a WaveLinx Area Controller (WAC) for full functionality. The WaveLinx PRO WW-Series Wallstation is used to provide local and multi-level control in spaces and can be mapped to multiple zones in an area to create customizable light levels from simple control to architectural.

All WaveLinx PRO control devices require at least one WaveLinx Area Controller for communications. Please ensure that you order a WaveLinx Area Controller (CATNO: WAC2-POE) the product to work or connect the wallstations to an existing WaveLinx Area Controller.

Important Note: The WaveLinx PRO WW-Series wallstation only works with the 2nd generation WaveLinx Area Controller (WAC2-POE). It does not work with the 1st generation WaveLinx Area Controller (WAC-POE).

Catalog Number

Standard Wallstation Configurations

Catalog Number	Description
WW1-W	WaveLinx PRO Wallstation, 1 Button, White
WW3-W	WaveLinx PRO Wallstation, 3 Button, White
WW3-RL-W	WaveLinx PRO Wallstation, 3 Button Raise / Lower, White
WW5-RL-W	WaveLinx PRO Wallstation, 5 Button Raise / Lower, White
Notes	Notes
WaveLinx PRO application required to customize programming for each button.	Suitable for use with standard decorator wall plates (not included). Complete wallstation - buttons are not field replaceable.

Custom Engraved Wallstation Configurations

Catalog Number	Description
WW1-W-ENGRV	WaveLinx PRO Wallstation, 1 Button, White, Custom Engraved
WW3-W-ENGRV	WaveLinx PRO Wallstation, 3 Button, White, Custom Engraved
WW3-RL-W-ENGRV	WaveLinx PRO Wallstation, 3 Button Raise / Lower, White, Custom Engraved
WW5-RL-W-ENGRV	WaveLinx PRO Wallstation, 5 Button Raise / Lower, White, Custom Engraved
Notes	Notes
WaveLinx PRO application required to customize programming for each button.	Suitable for use with standard decorator wall plates (not included). For custom engraving use the configurator tool within the FlashPro Program (CUST-ENGRV). Complete wallstation - buttons are not field replaceable.

Additional Accessories

Wallplates are not included with Wallstations. Please order separately.

Catalog Number

Catalog Number	Description
PJS26W	1 Gang Screwless Faceplate, White
PJS262W	2 Gang Screwless Faceplate, White
PJS263W	3 Gang Screwless Faceplate, White
PJS264W	4 Gang Screwless Faceplate, White
PJS265W	5 Gang Screwless Faceplate, White

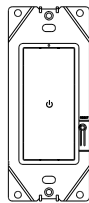

WW1-W

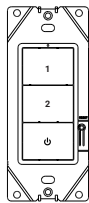

WW3-W

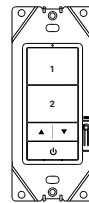

WW3-RL-W

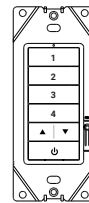

WW5-RL-W

Standard button engraving for each wallstation

Default engraving & light levels

Button 1	Scene 3 = 50%
Button 2	Scene 1 = 100%
Button 3	Scene 2 = 70%
Button 4	Scene 4 = 30%
Raise press*	Increase 1% (per press)
hold*	Increase 15% (per sec)
Lower press*	Decrease 1% (per press)
hold*	Decrease 15% (per sec)
Power*	Toggle Scene 3 (50%) & Scene 0 (Off)
	* - affects all zones in area

Raise / Lower / OFF buttons

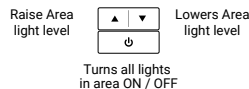

Button programming options via WaveLinx Pro Mobile Application

Scene Selection
Zone Level
Raise Level
Lower Level
Toggle Scene or Zone Level
No Action

Product Specifications

Key Features

- Easy installation and flexibility:
 - Scene selection
 - Zone control
 - Raise / Lower
 - Scene / Zone Toggle
 - ON / OFF
- Suitable for standard single or multi-gang NEMA wall box (wallplate not included)
- Mains (120/277 VAC) powered for simple new or retrofit installations
- Clean, elegant, and simple way to control lighting on your project
- Settings are programmable through software, no physical adjustments necessary

Mechanical

Size: 4.2"H x 1.8"W x 1.5"D (107mm x 45mm x 39mm)

Environment:

- **Operating temperature:** 32°F to 113°F (0°C to 45°C)
- **Storage temperature:** 32°F to 167°F (0°C to 75°C)
- **Relative humidity operating:** 5% to 95% non-condensing
- For indoor use only

Mounting: Standard decorator opening (wallplate not included)

Color: White

Electrical

Input power: 120-277VAC 50/60Hz (neutral wire required)

Input current: 5mA @120V and 5mA @277V

Hardware Specifications

Status Indicators:

- Single indicator LED
- LED functionality (active for 3 seconds after action)
 - Indication of wireless network join request
 - Indication of wireless network connection
 - Scene indication of operations

Button Configuration:

- 1 Button
- 3 Button
- 3 Button with Raise / Lower
- 5 Button with Raise / Lower

Software Specifications

- Each button programmable to trigger or toggle Scene or Zone
- Default values when joined to an area via WaveLinx Mobile application
- Models available with dominant button 50% light level
- Fade rates and scene transitions are programmable

Wireless Specifications

Radio: 2.4GHz

Standard: IEEE 802.15.4

Transmitter Power: + 7dBm

Configuration type: Router, End Point

Range: 100ft (30m) LOS through 2 interior walls of standard construction
 Note: Use of metallic wall plates is not recommended as they may interfere with the wireless signals

System Performance

Maximum number of Devices: 200 per WaveLinx Area Controller (best practice 150 devices)

Standards/Ratings*

- cULus Listed - Energy Management Equipment (UL916)
- FCC Part 15, Subpart B & C
- Meets latest ASHRAE Standard 90.1 requirements
- Meets latest IECC requirements
- Meets latest CEC Title 24 requirements
- NEMA WD-7 and NEMA 4 compliant
- CA Title 20 and Prop 65 compliant
- RoHS

Warranty

Five year warranty standard

Note: Use of ammonia based or VOC cleaners on this device must be avoided. Prolonged use may cause loss of integrity and expose electrified components. If this occurs, turn OFF power to the unit and replace.



Download the WaveLinx Mobile Application from either the Google Play or Apple Store®

*T24 and RoHS are self-tested by Cooper Lighting Solutions. Not a third party certification.

Dimensional Details

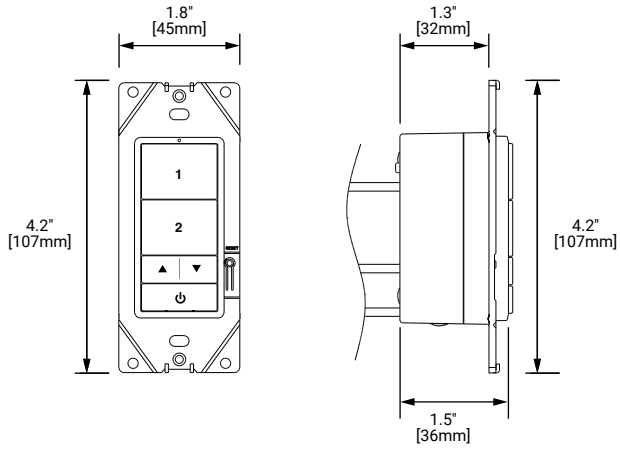

Mounting Height

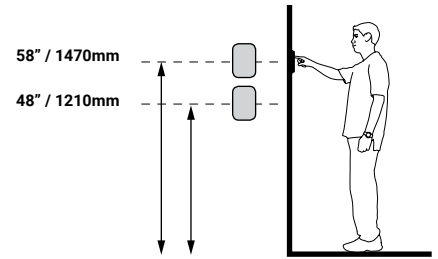

Installation

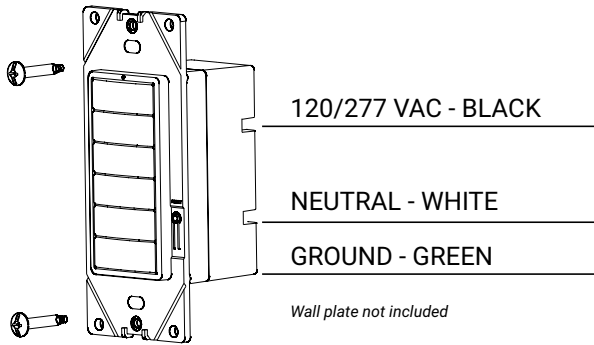

System Diagram:

This diagram shows the main components of the WaveLinX connected lighting system with CAT and PRO devices.

The PRO devices communicate using wireless mesh technology based on the IEEE 802.15.4 standard. A PoE LAN connection for each WaveLinX Area Controller (WAC) is required for power and data access to the building lighting network.

The CAT devices communicate over the category 5 based communication bus and control the light fixtures using a relay (on/off) and 0-10V output (dim/raise).

WaveLinX Area Controllers (WAC) communicate with WaveLinX CORE Apps over the Ethernet network.

[View WaveLinX Network and IT Guidance Technical Guide](#)

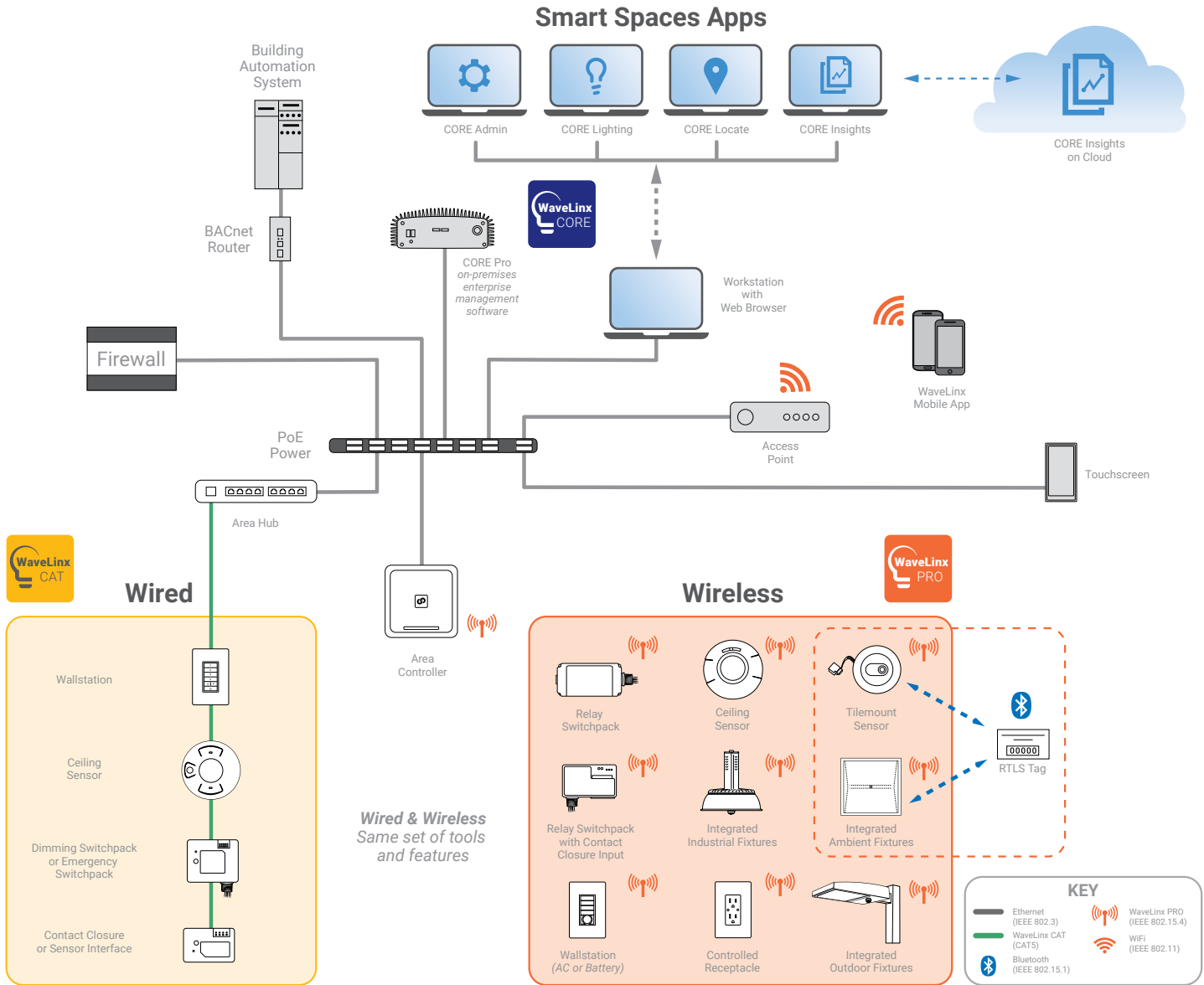

Control Systems
• WaveLinX