

<b>Project</b>		<b>Catalog #</b>		<b>Type</b>	
<b>Prepared by</b>		<b>Notes</b>		<b>Date</b>	



## PrentaLux

### Minaro

Integral LED Light Engine  
Statement Decorative

#### Typical Applications

• Office • Education • Healthcare • Hospitality • Retail • National Accounts

#### Interactive Menu

- Order Information [page 2](#)
- Product Specifications & Colors [page 3](#)
- Mounting [page 4](#)
- Photometric Data [page 5](#)
- Lumen/Wattage/LPW & UGR Data [page 5](#)



Filament only



damp location

### Top Product Features

- The PrentaLux Architecture Research Office Series Pendants utilize Cooper Lighting Solutions proprietary 3D printing process.
- Integral LED light engine comes in 3 sizes with up to 8 output levels per size ranging from nominal 150 lms to 2700+ lms.
- 90+ CRI standard with 4 CCT options (2700K, 3000K, 3500K, 4000K).
- Universal Voltage (120-277V).
- 0-10V integral driver with dimming from 100% to 1%.
- 5-year limited warranty.

### Dimensions

#### Minaro - SMALL

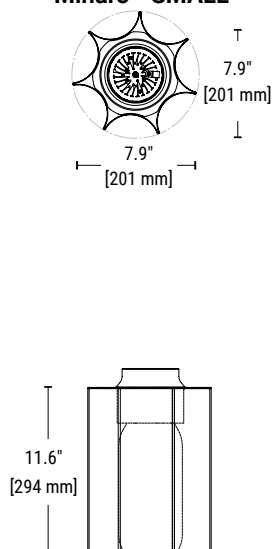

#### Minaro - MEDIUM

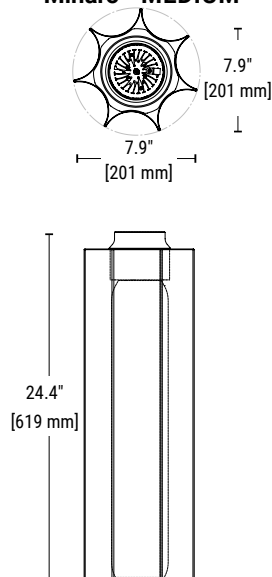

#### Minaro - LARGE

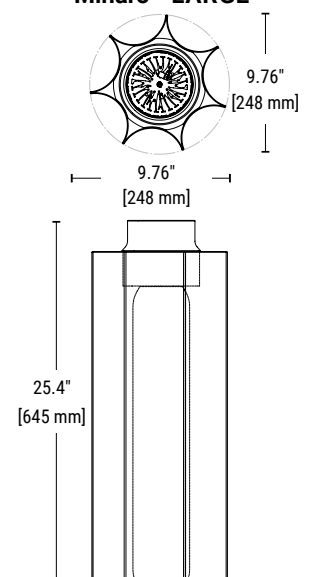

Order Information

SAMPLE CATALOG NUMBER: PRLX-MIN-M-927-06L-U-S-TRWH-NL-BRSS-C-W-DW

Domestic Preferences	Brand	Series	Fixture Size	CRI	Nominal Output (lms/W) <sup>1,2,3</sup>
[Blank] = Standard BAA = Buy American Act	PRLX	MIN = Minaro	S = Small M = Medium L = Large	927 = 90 CRI, 2700K 930 = 90 CRI, 3000K 935 = 90 CRI, 3500K 940 = 90 CRI, 4000K	<b>Small*</b> 02L = 250 Lumens/6.3W 05L = 500 Lumens/11.1W 07L = 750 Lumens/16.2W 09L = 1,000 Lumens/21.3W 12L = 1,200 Lumens/28.9W  <b>Medium*</b> 01L = 150 Lumens/6.3W 03L = 300 Lumens/11.1W 04L = 450 Lumens/16.2W 06L = 600 Lumens/21.3W 07L = 700 Lumens/28.9W  <b>Large**</b> 02L = 250 Lumens/5.6W 05L = 550 Lumens/14.8W 09L = 900 Lumens/22.6W 12L = 1250 Lumens/30.5W 16L = 1600 Lumens/38.8W 20L = 2000 Lumens/48.6W 23L = 2350 Lumens/58.2W 27L = 2700 Lumens/69.4W
Notes	Notes	Notes	Notes	Notes	Notes
1. Only product configurations with this designated prefix are built to be compliant with the Buy American Act of 1933 (BAA). Please refer to <a href="#">DOMESTIC PREFERENCES</a> website for more information. Components shipped separately may be separately analyzed under domestic preference requirements.					1. Nominal lumen output values above are based on 90 CRI, 3500K values and Flat Lens Diffuser. Use IES files for accurate calculations.  2. See Lumen Output tables on pages 6, 8, and 10 for output by optic, CCT and output level.  * = Small and Medium Sizes uses small light engine ** = Large Size uses medium light engine

Voltage	Dimming	Shade Color	Shade Texture
U = Universal Voltage (120-277V)	S = 0-10V (dimming from 100% to 1%)	TRWH = Translucent White	NL = Natural Lines OW = Open Weave PS = Pinstripe
Notes	Notes	Notes	Notes

Accessories

Finial Color	Mounting Type	Power Cord Color	Rigid Stem Length	Canopy	Stem Kit
WHITE = White BLAK = Black GRAY = Gray ROSE = Rose CAPP = Cappuccino SAGE = Sage BRNZ = Bronze BRSS = Brass SLVR = Silver	C = Air Craft Cable R = Rigid Stem	[Blank] = Rigid Stem (ordered separately) W = White B = Black	[Blank] = Air Craft Cable Selected 36 = 36 inches 48 = 48 inches 96 = 96 inches	DW = Disk - White DB = Disk - Black DC = Disk - Matches Finial Color	3DPSTEMASY36WHT = 36" White Stem Kit 3DPSTEMASY48WHT = 48" White Stem Kit 3DPSTEMASY96WHT = 96" White Stem Kit  3DPSTEMASY36BLK = 36" Black Stem Kit 3DPSTEMASY48BLK = 48" Black Stem Kit 3DPSTEMASY96BLK = 96" Black Stem Kit
Notes	Notes	Notes	Notes	Notes	Notes
	1. Rigid stem kit must be ordered separately as an accessory as an accessory. See Accessories ordering information for stem accessory kit ordering codes.	1. Standard length of cord - 10ft [3050 mm]. Max available length is 25ft [7.62 m]. Consult factory for lengths longer than 10ft.	1. Rigid stem selection for wire length provided with fixture and canopy. Stem kit ordered separately.		1. Rigid stem must be ordered separately as an accessory.

## Product Specifications

### Construction

- PrentaLux Minaro consists of an integral LED light engine and a proprietary additive manufacturing process for the polycarbonate shade and components.
- Minaro shades utilize a proprietary, impact resistant polycarbonate for maximum durability.
- The polycarbonate used for PrentaLux fixtures is bio-circular and thermally, mechanically and optically optimized for professional/commercial installations. Designed, engineered, and printed in the United States.

### Electrical

- Standard 0-10V driver (with dimming from 100% to 1%) integrated into the canopy (120/277V/50-60Hz).

### LED & Light Engine

- Available in 2700K, 3000K, 3500K, and 4000K CCT.
- 90 CRI standard.
- Up to 8 lumen packages ranging from nominal 250 to 2700+ lumens. (subject to specific CCT and Light Level).

### Driver

- Standard offering is 0-10V with 1% dimming.

### Optics

- Inner diffuser and outer translucent white shade.
- Polar plot and UGR data on pages 5, 6 & 7.

### Environment

- Suited for 25° Celsius ambient. Suitable for damp locations.

### Shielding

- Deep regress of light source inside the inner diffuser and outer shade creates excellent cutoff.

### Colors & Textures

- Translucent white shade paired with choice of 9 standard finial and canopy colors.
- 3 shade texture options.
- On-Demand finial and canopy colors available with possible extended lead times and additional costs. Please consult factory.

### Mounting

- Mounting options include 3D printed canopy, mounting hardware, and UL certified cord with aircraft cable or rigid stem.

### Lengths

- Aircraft Cable mounting with 10ft cord. Lengths up to 25ft possible. (Consult factory as longer lead times apply).
- Standard rigid stem lengths are 36", 48" and 96". Rigid stem mounting comes with respective lengths of power and dimming wires with the fixture.

### Weight

- All products are lightweight and much easier to install than traditional pendants.
- Weight does not include canopy or mounting.
- Small Minaro fixture weighs approximately 3 lbs.
- Medium Minaro fixture weighs approximately 5 lbs.
- Large Minaro fixture weighs approximately 7 lbs.

### Warranty

- Standard five-year limited warranty on all parts. [cooperlighting.com/legal](http://cooperlighting.com/legal).

### Compliance

- Components are UL recognized and luminaires are cULus listed for 25°C ambient environments. Damp Location listed.
- Filament material is UL certified.
- BAA compliant options available.
- RoHS compliant.
- ISCC certified (for 3D printed materials). PrentaLux products will convert to printing our 3D parts with over 75% recycled or bio-circular materials (using an ISCC certified mass balance approach). Bio-circular materials are raw materials from ISCC Plus certified waste streams and residues including tall oils from the wood processing industry or used cooking oil from the food processing industry.
- Not to be installed in food prep areas and hazardous environments which may expose the product to pollutants such as oil, grease, or VOCs.
- Not for installations in locations such as gymnasiums, arenas, sports complexes, multi-purpose rooms, and any other locations where the fixture potentially will be subject to impacts from external sources.

### Sustainability Specifications

- PrentaLux 3D printed parts are produced with at least 75% recycled or bio-circular materials (using an ISCC certified mass balance approach).
- ISCC certified. Certification applies only to 3D printed material.

## Shade Color

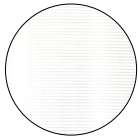

TRWH - Translucent White

## Shade Textures

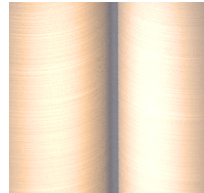

NL - Natural Lines

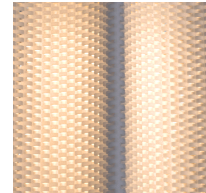

OW - Open Weave

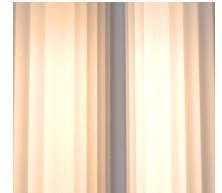

PS - Pinstripe

## Standard Finial and Canopy Colors



WHTE - White



BLAK - Black



GRAY - Gray

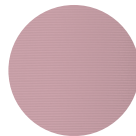

ROSE - Rose

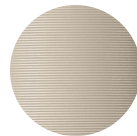

CAPP - Cappuccino

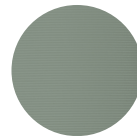

SAGE - Sage



BRNZ - Bronze

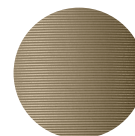

BRSS - Brass

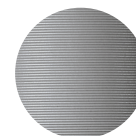

SLVR - Silver

## On-Demand Colors

These additional color offerings for finial and canopy may have extended lead times and/or additional costs. Please consult factory.



ENGR - Enamel Green

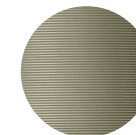

MEGR - Metallic Green



MCHA - Matcha



STBL - Steel Blue

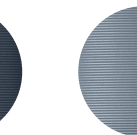

MEBL - Metallic Blue

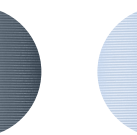

MYBL - Misty Blue

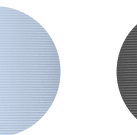

DKGY - Dark Gray

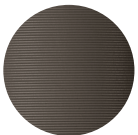

STBR - Stone Brown

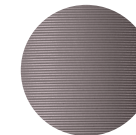

MEPU - Metallic Purple

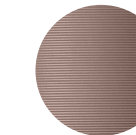

RGLD - Rose Gold



CITR - Citrona



CRWH - Cream White



BURG - Burgundy

Mounting - Canopy Options

Rigid Stem Canopy

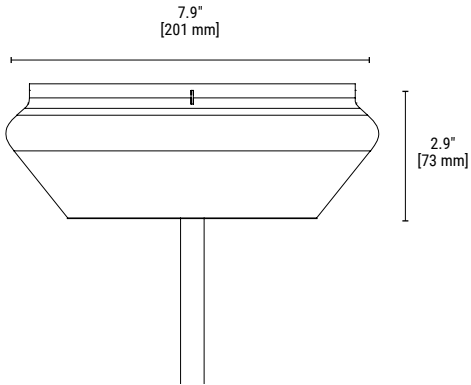

Aircraft Cable Canopy

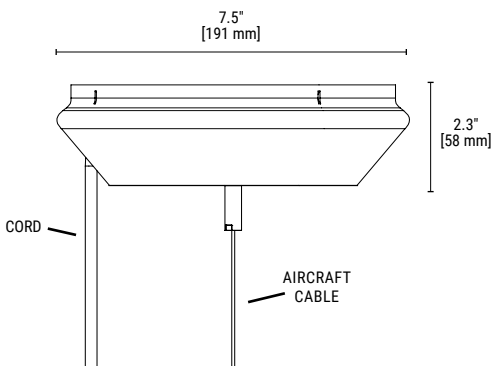

Canopy Colors

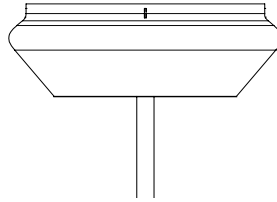

DW = Disk - White

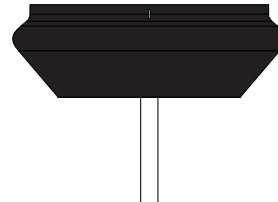

DB = Disk - Black

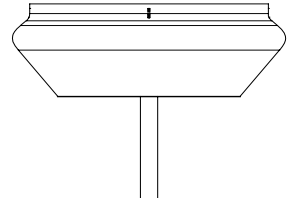

DC = Disk - Matches Finial Color

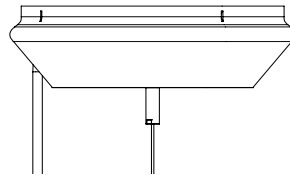

DW = Disk - White

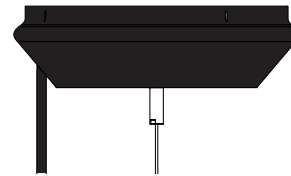

DB = Disk - Black

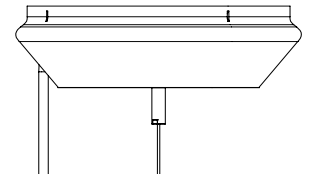

DC = Disk - Matches Finial Color

Diffuser

Shown in small, medium and large sizes.

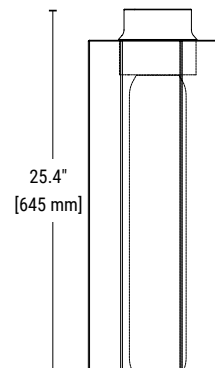
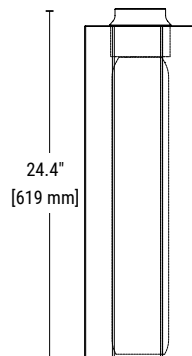
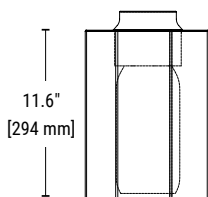

Photometric Data - Minaro - Small

PRENTALUX - MINARO - SMALL - @ 3500K / 90 CRI		
Light Level 12L		
Filename	PRLX-MIN-S-935-12L-U-OW.ies	
Test No.	P1244982	
Lumcat	PRLX-MIN-S-935-12L-U-OW	
Lumens	1305.2 Lm	
Input Watts	28.9 W	
Efficacy LPW	45.2 Lm/W	
CCT	3500K	
Spacing Criteria (0/90/45)	0.43 / 0.43 / 0.38	

Note: Refer to IES files for more product data.

Color Data (3500K)

		90CRI
TM-30	R <sub>f</sub>	92.5
	R <sub>g</sub>	98.6
CRI/CIE	R <sub>9</sub>	71.6

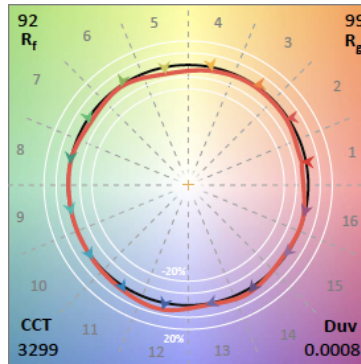

Lumen/Wattage/LPW Table - Minaro - Small

LUMEN Table per CRI, CCT, and Light Level			Nominal Lumens			WATTS (120V)	EFFICACY (Lm/W)		
CRI	CCT	LL	NL	RB	OW		NL	RB	OW
90	2700K	02L	216	244	243	6.3	34	39	39
		05L	452	509	507	11.1	41	46	46
		07L	662	745	742	16.2	41	46	46
		10L	848	955	952	21.3	40	45	45
		12L	1062	1196	1192	28.9	37	41	41
	3000K	02L	229	259	258	6.3	36	41	41
		05L	479	539	537	11.1	43	49	48
		07L	701	790	787	16.2	43	49	49
		10L	899	1013	1009	21.3	42	48	47
		12L	1126	1268	1263	28.9	39	44	44
	3500K	02L	237	267	266	6.3	38	42	42
		05L	495	557	555	11.1	45	50	50
		07L	725	816	813	16.2	45	50	50
		10L	929	1046	1042	21.3	44	49	49
		12L	1163	1310	1305	28.9	40	45	45
	4000K	02L	246	277	276	6.3	39	44	44
		05L	513	578	576	11.1	46	52	52
		07L	751	846	843	16.2	46	52	52
		10L	963	1085	1081	21.3	45	51	51
		12L	1206	1359	1354	28.9	42	47	47

Photometric Data - Minaro - Medium

PRENTALUX - MINARO - MEDIUM - @ 3500K / 90 CRI		
Light Level 07L		
Filename	PRLX-MIN-M-935-07L-U-OW.ies	
Test No.	P1244922	
Lumcat	PRLX-MIN-M-935-07L-U-OW	
Lumens	772 Lm	
Input Watts	28.9 W	
Efficacy LPW	26.7 Lm/W	
CCT	3500K	
Spacing Criteria (0/90/45)	0.21 / 0.21 / 0.18	

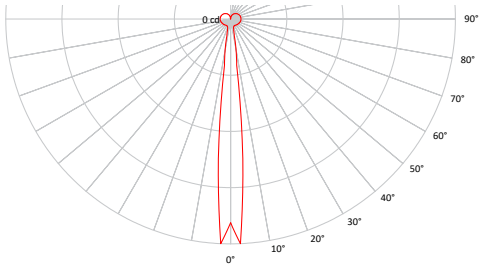

Note: Refer to IES files for more product data.

Color Data (3500K)

		90CRI
TM-30	R <sub>f</sub>	92.5
	R <sub>g</sub>	98.6
CRI/CIE	R <sub>9</sub>	71.6

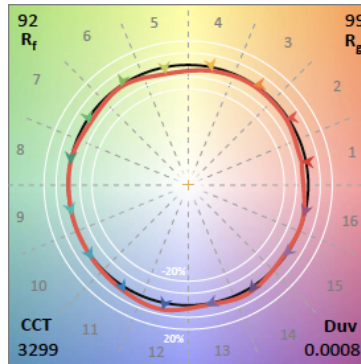

Lumen/Wattage/LPW Table - Minaro - Medium

LUMEN Table per CRI, CCT, and Light Level			Nominal Lumens			WATTS (120V)	EFFICACY (Lm/W)		
CRI	CCT	LL	NL	RB	OW		NL	RB	OW
90	2700K	01L	130	146	146	6.3	21	23	23
		03L	270	304	303	11.1	24	27	27
		04L	392	442	440	16.2	24	27	27
		06L	502	565	563	21.3	24	27	26
		07L	629	708	705	28.9	22	24	24
	3000K	01L	138	155	154	6.3	22	25	24
		03L	286	322	321	11.1	26	29	29
		04L	416	468	466	16.2	26	29	29
		06L	532	599	597	21.3	25	28	28
		07L	666	751	748	28.9	23	26	26
	3500K	01L	142	160	159	6.3	23	25	25
		03L	295	333	331	11.1	27	30	30
		04L	429	484	482	16.2	26	30	30
		06L	549	619	616	21.3	26	29	29
		07L	688	775	772	28.9	24	27	27
	4000K	01L	147	166	165	6.3	23	26	26
		03L	306	345	344	11.1	28	31	31
		04L	445	502	500	16.2	27	31	31
		06L	570	642	639	21.3	27	30	30
		07L	714	804	801	28.9	25	28	28

Photometric Data - Minaro - Large

PRENTALUX - MINARO - LARGE - @ 3500K / 90 CR		
Light Level 27L		
Filename	PRLX-MIN-L-935-27L-U-OW.ies	
Test No.	P1244853	
Lumcat	PRLX-MIN-L-935-27L-U-OW	
Lumens	2901.1 Lm	
Input Watts	69.4 W	
Efficacy LPW	41.8 Lm/W	
CCT	3500K	
Spacing Criteria (0/90/45)	0.2 / 0.2 / 0.18	

Note: Refer to IES files for more product data.

Color Data (3500K)

		90CRI
TM-30	R <sub>f</sub>	92.5
	R <sub>g</sub>	98.6
CRI/CIE	R <sub>9</sub>	70.2

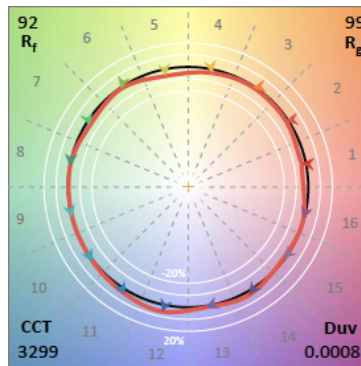

Lumen/Wattage/LPW Table - Minaro - Large

LUMEN Table per CRI, CCT, and Light Level			Nominal Lumens			WATTS (120V)	EFFICACY (Lm/W)		
CRI	CCT	LL	NL	RB	OW		NL	RB	OW
90	2700K	02L	213	239	239	5.6	38	43	43
		05L	473	533	531	14.8	32	36	36
		09L	791	892	888	22.6	35	39	39
		12L	1090	1227	1223	30.5	36	40	40
		16L	1406	1584	1578	38.8	36	41	41
		20L	1739	1959	1952	48.6	36	40	40
		23L	2041	2299	2291	58.2	35	40	39
		27L	2361	2659	2649	69.4	34	38	38
	3000K	02L	225	254	253	5.6	40	45	45
		05L	501	565	563	14.8	34	38	38
		09L	839	945	942	22.6	37	42	42
		12L	1155	1301	1296	30.5	38	43	42
		16L	1491	1679	1673	38.8	38	43	43
		20L	1844	2077	2069	48.6	38	43	43
		23L	2164	2438	2428	58.2	37	42	42
		27L	2503	2819	2808	69.4	36	41	40
	3500K	02L	233	262	261	5.6	42	47	47
		05L	518	583	581	14.8	35	39	39
		09L	867	976	973	22.6	38	43	43
		12L	1193	1344	1339	30.5	39	44	44
		16L	1540	1735	1728	38.8	40	45	45
		20L	1905	2145	2137	48.6	39	44	44
		23L	2235	2518	2508	58.2	38	43	43
		27L	2585	2912	2901	69.4	37	42	42
	4000K	02L	241	272	271	5.6	43	49	48
		05L	537	605	603	14.8	36	41	41
		09L	899	1013	1009	22.6	40	45	45
		12L	1238	1394	1389	30.5	41	46	46
16L		1597	1799	1792	38.8	41	46	46	
20L		1976	2225	2217	48.6	41	46	46	
23L		2318	2611	2602	58.2	40	45	45	
27L		2681	3020	3009	69.4	39	44	43	