

Project		Catalog #		Type	
Prepared by		Notes		Date	



# Fail-Safe



## ArcMed Sealed InDepth 22AID

2x2 ArcMed Sealed InDepth  
Clear Bottom Lens

### Typical Applications

Healthcare • Behavioral Health • Cleanroom • Education • Laboratory • Wet Location

### Product Certification



### Systems | Features & Awards



### Interactive Menu

- Order Information [page 2](#)
- Connected Systems [page 6](#)
- Product Warranty

### Top Product Features

- Choice of 5 lens options to add visual interest to the space - designer delight!
- Clear bottom lens provides a tight seal, to protect against dust, debris, and water ingress. IP65 rated.
- Clear polycarbonate bottom lens offers IK10 impact resistance rating; ideal for use in **behavioral health applications**. **Ligature resistant**
- Clear bottom lens enables an NSF compliance for easy wipedown/cleaning - also for use in food service, food prep, and food processing applications
- ISO3-8 certified and BSL 1-4 rated for use in medical and cleanroom applications
- Options to meet Trade Agreements Act requirements

### Lens Options

[additional product diagrams](#)

#### 2x2 Regressed Cubes

#### 2x2 Regressed Curves

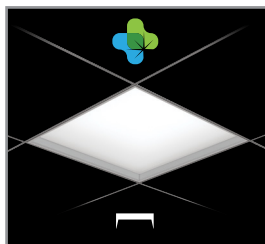

**CFR1**  
1" Cube Regress

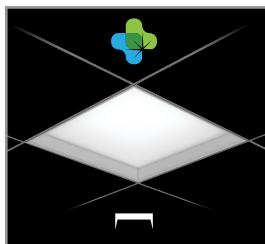

**CFR2**  
2" Cube Regress

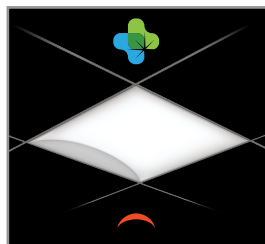

**CNC**  
2" Curve Regress

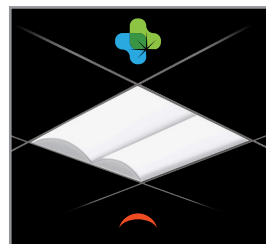

**DBR**  
2" Double Barrel Regressed

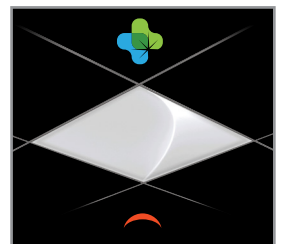

**SWR**  
Sweep Regressed



Order Information

SAMPLE ORDER NUMBER: 22AID-55-SWR-CP125-L835-U

Domestic Preferences <sup>(1)</sup>	Rating	Series	Lumen Output <sup>(2)</sup>	Shielding <sup>(5)</sup>	Bottom Lens	Voltage	Options	
<b>[Blank]</b> =Standard <b>TAA</b> =Trade Agreements Act	<b>[Blank]</b> =Standard <b>ATW-SW4</b> =Chicago Rated	<b>22AID</b> =2x2 ArcMed InDepth	<b>Standard Efficacy</b> 20=2000 Lumens 25=2500 Lumens 30=3000 Lumens 35=3500 Lumens 40=4000 Lumens 45=4500 Lumens	50=5000 Lumens 55=5500 Lumens 60=6000 Lumens 70=7000 Lumens <sup>(3)</sup> 80=8000 Lumens <sup>(3)</sup>	<b>CFR1</b> =1" Cube Regressed <b>CFR2</b> =2" Cube Regressed <b>CNC</b> =2" Curve Regressed <b>DBR</b> =2" Double Barrel Regressed <b>SWR</b> =Sweep Regressed <sup>(4)</sup>	<b>CA08</b> =0.080" Clear Acrylic <b>CA125</b> =0.125" Clear Acrylic <b>CP125</b> =0.125" Clear Polycarbonate <b>CP187</b> =0.187" Clear Polycarbonate <b>CP250</b> =0.250" Clear Polycarbonate	<b>[Blank]</b> =Universal Voltage 120-277 <b>347V</b> =347 Volt <sup>(7)</sup> <b>48V</b> =48 Volt Low-voltage (Class 2) <sup>(8)</sup>	<b>GL</b> =Single Element Fuse <b>GM</b> =Double Element Fuse
<b>Notes</b> (1) Only product configurations with this designated prefix are built to be compliant with the Trade Agreements Act of 1979 (TAA). Please refer to <a href="#">DOMESTIC PREFERENCES</a> website for more information. Components shipped separately may be separately analyzed under domestic preference requirements.		<b>Notes</b> (2) Lumens are approximate. Use IES files for actual performance. (3) SLTHD Driver not available on 70 and 80.		<b>Notes</b> (5) 1" and 2" options may be ordered as regressed or drop or they can be converted on site. 3" option must be factory ordered. (6) Sweep lens only available in 2x2 size.		<b>Notes</b> (7) 347 with emergency not available with SD driver. (C) Consult WaveLinX Low-Voltage or DLVP system pages for additional details and compatibility.		

Emergency Options	CRI/CCT	Flex <sup>(11)</sup>
<b>[Blank]</b> =No emergency <b>EL7W</b> =7-watt, 120V-277V emergency battery pack installed <sup>(8)</sup> <b>EL14W</b> =14-watt 120V-277V emergency battery pack installed <sup>(8)</sup> <b>ELV7W</b> =Low-voltage system, 7-watt emergency battery pack <sup>(8),(9)</sup> <b>ELV14W</b> =Low-voltage system, 14-watt emergency battery pack <sup>(8),(9)</sup> <b>EL10WSD</b> =Bodine 10W emergency battery pack with self diagnostic installed <sup>(8),(10)</sup> <b>ETRD</b> =Emergency Transfer Relay with dimming control <sup>(9)</sup>	<b>L830</b> =80CRI, 3000K <b>L835</b> =80CRI, 3500K <b>L840</b> =80CRI, 4000K <b>L850</b> =80CRI, 5000K	<b>[Blank]</b> =No Flex <b>A3/8-4/18GDIM</b> =3/8" Flex with 0-10V Dimming Leads <b>A3/8-2/18G</b> =3/8" Flex with line and common <b>A3/8-5/18GDIM</b> =Flex with 0-10V Dimming leads and Blue for alternate wiring. See below for details.
<b>Notes</b> (8) With remote test switch/indicator/laser test. For approximate delivered lumens multiply the lumens per watt of the desired fixture by the wattage of the emergency battery pack (100 lm/W x 7=700 lumens). IES-format photometry for luminaire under emergency operation available. (9) Used to bypass local control during outage. Must be used in conjunction with UL 1008 device (provided by others). ETRD option only requires one relay when used on a dimming fixture. Must specify voltage as 120V or 277V when ordering these devices. (10) EL10WSD not available with 347V. (C) Consult WaveLinX Low-Voltage or DLVP system pages for additional details and compatibility.		<b>Flexible Metal Conduit Options</b> (11) Multiple options available in online configurator. See additional notes on Flex below. Flex options available for 0-10V dimming control, DALI dimming control, emergency and night light functions. 72-inch factory-installed and pre-wired to driver, fitted to luminaire housing access plate with 90° enclosed FMC connector. Not all options may be combined and installation ratings vary by type. <b>A3/8-***** series notes:</b> Factory installed dimming option 3/8" flexible metal conduit with 2-#18 power and ground wires and 2-#18 UL-listed jacketed 0-10V +/- control wires. Meets UL 66, 83, 1479, 1569, 1581, 2556, NEC® 250.118, 300.22(C), 392, 396, 330, 501, 502, 503, 530, 504, 505, 518, 520, 530, 645, 72; Federal Specification A-A-59544 (formerly J-C-30B); all applicable OSHA and HUD Requirements. UL Classified 1-, 2-, and 3-hour through penetration with applicable fire stop product (not included). May be surface mounted, fished and/or embedded in plaster. Cable tray and approved raceway rated, install per NEC®; Environmental Air-Handling Space Installation per NEC® 300.22(C).

Driver Type	Number of Drivers	Integrated Sensing Systems	Options	Accessories (order separately) <sup>(13)</sup>
<b>[Blank]</b> =0-10V Driver (1%-100% Dimming) <b>SLTD</b> =DALI Driver (5%-100% Dimming) <b>SLTHD</b> =DALI Driver (1%-100% Dimming) <b>LV1</b> =Low-voltage System Driver (0%-100% Dimming) <sup>(2)</sup> <b>SD</b> =Step Dimming Driver (50%, 100% Dimming) <b>LH</b> =Lutron HiLume (LDE1 series) 1%-100% EcoSystem Driver with Soft-on Fade to Black dimming <sup>(2)</sup>	<b>[Blank]</b> =1 Driver	<b>[Blank]</b> =No Sensor <b>WTA</b> =Factory installed WaveLinX Pro Tile-mounted Sensor Kit <sup>(A),(12)</sup> <b>WTK</b> =Factory installed WaveLinX Lite Tile-mounted Sensor Kit <sup>(B),(12)</sup>	<b>[Blank]</b> =None <b>AM</b> =Anti Microbial Finish	<b>T3A END E.Q. BRACKET PARTS BAG (Standard with fixture)</b> <b>DFCL-2424W-U</b> =2' x 2' Wet Location Drywall Frame Kit <sup>(15),(16)</sup> <b>SK-22-WS</b> =2' x 2' Shallow Surface Mount Kit <sup>(14)</sup> <b>DFVR/AID-2424W-U</b> =2' x 2' vandal resistant gasketed drywall framing kit. Ships with gasket to be applied in field. Cut out dimension 24.25" x 24.25" <sup>(17)</sup>
<b>Notes</b> Integrated options must be used in conjunction with the associated system and may not be compatible with other options or accessories. Please refer to the following: (C) Consult WaveLinX Low-Voltage or DLVP system pages for additional details and compatibility. (F) Consult Marketplace Options - Lutron system pages for additional details and compatibility. Compatible only with driver series shown, and may require two or more drivers. Requires field commissioning to operate or dim. Contact Lutron at <a href="#">www.lutron.com</a>		<b>Notes</b> (12) WTA and WTK sensor options to be used with default driver. Integrated options must be used in conjunction with the associated system and may not be compatible with other options or accessories. Please refer to the following: (A) Consult WaveLinX Pro system pages for additional details and compatibility. (B) WaveLinX Lite devices are not currently compatible with the WaveLinX Wireless Area Controller. Consult WaveLinX Lite system pages for additional details and compatibility.		<b>Notes</b> (13) Accessories sold separately will be separately analyzed under domestic preference requirements. Consult factory for further information. (14) Surface Kit damp location only, not designed for vandal resistant applications. (15) Cutout Dimensions 24.25" x 24.25". (16) Replace W with AMW for antimicrobial matte white drywall kit. (17) IP66 standard with DFVR/AID drywall kit



## Product Specifications

### Construction

- Extruded aluminum rails form rigid housing for robust life and aesthetic appeal
- EQ/grid clips are included to ensure code compliance for all regions
- Four auxiliary fixture corner suspension points for use when suspending fixture
- Driver enclosures use access plate to speed wiring and conduit installation with additional KO on sides. Six KOs.

### Integrated Controls

- 0-10V dimming to 1% standard
- Tile mount WaveLinX sensor compatible for standalone, controlled, connected, and IoT capability
- Tile mount Enlighted sensor compatible for IoT capability
- Low-voltage driver compatible for WaveLinX Low-Voltage and DLVP applications
- DALI 2.0, Lutron, and step-dimming available

### LED and Light Engine

- LED's available in 3000K, 3500K, 4000K, or 5000K at 80 CRI minimum
- TM21 life at 60,000 hours up to L86 and calculated L70 exceeds 131,000 hrs.
- Drivers available in 120-277V and 347V

### Emergency Battery Options

- Optional 120-277V emergency battery available in 7W, 10W or 14W
- 90-minute backup period for code compliance
- Test switch ships with the battery versions and is installed remote from fixture to ensure aesthetics.
- Generator transfer options available

### Finish

- 90% reflective, matte white enamel finish
- Full fixture housing painted after fabrication
- Back plate and J-box are constructed of code gauge steel

### Shielding

- Multiple acrylic diffuser options enable regression options
- Formed frosted acrylic diffuser provides visual interest and obscures the LEDs
- Diffuser texture is specifically designed to limit glare
- 5 lens options enables versatility in many spaces
- Clear acrylic or polycarbonate flat bottom lens

### Compliance

- IC rated for insulation contact
- cULus listed for wet location
- IP65 from below the luminaire/ceiling
- NSF
- IK10 Impact Rating for all polycarbonate lens options
- RoHS compliant
- Tested to IESNA LM-79 and LM-80
- Stated life tested to TM21 standards
- Tested for ISO 5 compliance. ISO3 and ISO4 environments typically employ uni-directional vertical air-flow and a ventilated raised floor to remove airborne particles. Not uncommon for the entire ceiling to be either HEPA or ULPA filters. Filtered air is continually directed downward, passing through the ventilated raised floor, and recirculated – to remove more of the airborne particles than are created. Often, laminar-flow surface mount luminaires are used to illuminate the space. With proper air flow and air exchanges, proper installation, this non-shedding luminaire is acceptable for use in ISO3-9 environments.
- Qualifies as State of California Title 24 high efficacy luminaire
- Meets BSL 1-4 when specified in catalog logic

### Warranty

- Five year warranty standard. Extended ten year warranty available.

## Dimensional Details

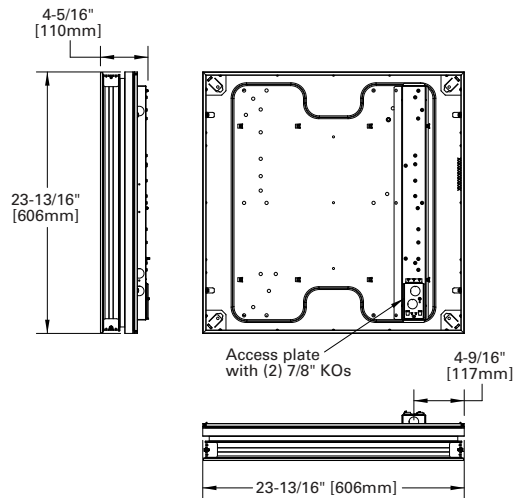

## Ceiling Compatibility

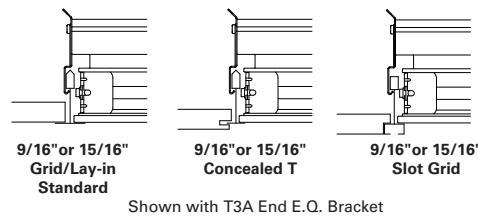

## Bottom Lens Cross Section

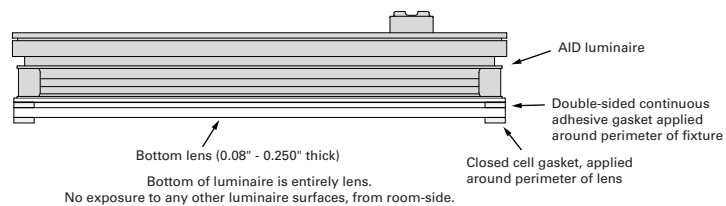

## Energy and Performance Data

### Electrical Performance - 2x2 (4000K, CA08 bottom lens)

Lumen Pkg	Delivered Nominal Lumens					Power Watts	Efficacy (LPW)				
	CFR1	CFR2	CNC	DBR	SWR		CFR1	CFR2	CNC	DBR	SWR
2000	2074	2083	2068	2055	2039	16.3	127	128	127	126	125
2500	2641	2652	2633	2620	2601	20.7	128	128	127	127	126
3000	3091	3104	3082	3068	3045	24.3	127	128	127	126	125
3500	3642	3657	3631	3618	3592	28.4	128	129	128	127	126
4000	4086	4102	4073	4098	4068	32.7	125	125	125	125	124
4500	4616	4634	4602	4621	4588	37.5	123	124	123	123	122
5000	5175	5196	5160	5131	5092	41.5	125	125	124	124	123
5500	5688	5711	5671	5647	5605	46.3	123	123	122	122	121
6000	6196	6221	6178	6189	6143	51.4	121	121	120	120	120
6500	6682	6709	6662	6664	6614	56.6	118	119	118	118	117
7000	7240	7269	7218	7222	7168	61.8	117	118	117	117	116
7500	7703	7734	7680	7686	7628	66.8	115	116	115	115	114
8000	8139	8171	8114	8125	8065	71.8	113	114	113	113	112

### Lumen Calculator

CCT	80 CRI Multiplier
3000K	0.95
3500K	0.97
4000K	1
5000K	1.03

Lens	Lumen Multiplier	Lens Description
CA08	1	Clear Acrylic, 0.080" thick
CA125	0.98	Clear Acrylic, 0.125" thick
CP125	0.95	Clear Polycarbonate, 0.125" thick
CP187	0.93	Clear Polycarbonate, 0.187" thick
CP250	0.92	Clear Polycarbonate, 0.250" thick

### Optical Performance - 2x2 (4000K, CA08 Bottom Lens)

Lumen Pkg	UGR [CIE 190:2010] <sup>(1)</sup> (4H, 8H; Reflectance: 70% Ceiling, 50% Wall, 20% Ref. Plane)					Max. Luminance [45-90 Deg. from NADIR] <sup>(2)</sup> (CD/M <sup>2</sup> )				
	CFR1	CFR2	CNC	DBR	SWR	CFR1	CFR2	CNC	DBR	SWR
2000	17.9	17.9	17.9	17.8	17.8	2003	2011	1997	1984	1969
2500	18.7	18.7	18.7	18.7	18.7	2550	2561	2543	2530	2512
3000	19.3	19.3	19.3	19.2	19.2	2985	2997	2976	2963	2940
3500	19.8	19.9	19.8	19.8	19.8	3517	3531	3506	3494	3469
4000	20.2	20.2	20.2	20.2	20.2	3946	3961	3933	3957	3928
4500	20.7	20.7	20.6	20.7	20.6	4457	4475	4444	4462	4430
5000	21.1	21.1	21	21	21	4997	5017	4983	4955	4917
5500	21.4	21.4	21.4	21.4	21.3	5493	5515	5476	5453	5412
6000	21.7	21.7	21.7	21.7	21.7	5983	6007	5966	5976	5932
6500	21.9	22	21.9	21.9	21.9	6452	6478	6433	6435	6387
7000	22.2	22.2	22.2	22.2	22.2	6991	7019	6970	6974	6922
7500	22.4	22.5	22.4	22.4	22.4	7438	7468	7416	7422	7366
8000	22.6	22.6	22.6	22.6	22.6	7859	7890	7835	7846	7788

Notes: (1) For other UGR data for room or reflective ceiling plans please see technical data on website. (2) For other CCT please see technical data on website.

### Nominal Lumen Maintenance

TM-21 Lumen Maintenance (60,000 hours)	Theoretical L70 (hours) <sup>(3)</sup>
> 86%	> 131,000

Notes: (3) Theoretical values represent estimations. Refer to LED Product Lifetime Prediction, IES PS-10-18, that explains proper use of IES TM-21 and LM-80.

### Typical Load Data

THD	6%
Power Factor	0.99
Low Temp. Start	-20°C

### Shipping Data

Bottom Lens	Weight (lbs)	Units per Pallet 49"L x 52"W x 55"H	Lens Description
CA08	18	18	Clear Acrylic, 0.080" thick
CA125	19.1	18	Clear Acrylic, 0.125" thick
CP125	18.9	18	Clear Polycarbonate, 0.125" thick
CP187	20.3	18	Clear Polycarbonate, 0.187" thick
CP250	21.9	18	Clear Polycarbonate, 0.250" thick



### Control Systems

- WaveLinx Pro Wireless
- WaveLinx Lite Wireless
- WaveLinx Wired
- DLVP



**Connected Systems**  
[CLICK HERE](#)

The InDepth with factory-installed tile mount sensor provides automatic energy savings without sacrificing performance. The InDepth delivers superior lighting with luminaire occupancy and daylighting control.

For standalone and controlled applications, the WaveLinx Lite sensor provides out-of-the-box functionality with no gateways required and factory startup is not needed.

When more connectivity is required, the WaveLinx Pro Wireless sensor meets modern code and utility requirements, delivers energy and cost savings, while enabling buildings to become smart buildings.

The WaveLinx Wireless Connected Lighting System combined with Trellix provides an open IoT platform and infrastructure that connects intelligent sensors leveraging the real-estate of the physical light fixture to solve higher complexity problems to deliver actionable insights through the aggregation of valuable data.

TOP VIEW:

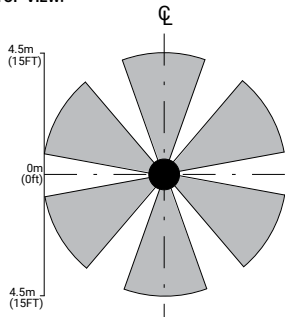

SIDE VIEW:

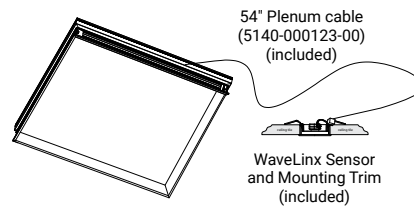
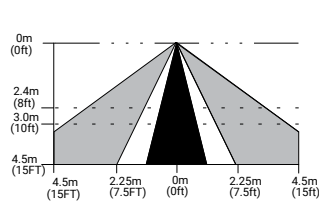

For more information on tilemount sensor specifications and installation, see WaveLinx Pro and WaveLinx Lite Tilemount Sensor Kit at [cooperlighting.com](#).

**Note:** Installation of integrated sensors within 3-ft (1m) of HVAC air vents is not recommended. The pattern shown is intended solely as a general guide and is not to scale.

### Systems comparison chart

Cooper Lighting Solutions provides many lighting system solutions designed to satisfy code requirements and meet the unique needs of any project.



**Luminaire with standalone sensor**



**Standalone Spaces WaveLinx LITE**



**Standalone Spaces WaveLinx CAT**



**Networked Spaces WaveLinx PRO**



**Enterprise WaveLinx CORE**

<b>Occupancy</b>	Yes	Yes	Yes	Yes	Yes
<b>Daylighting</b>	Yes	Yes	Yes	Yes	Yes
<b>Wallstations</b>	-	Yes	Yes	Yes	Yes
<b>Gateways</b>	-	-	-	1 WAC	300 WACs
<b>Devices (MAX)</b>	-	40 per Area (1120 per space)	40 per Area	200 per WAC2	32,500 per CORE Enterprise
<b>Software</b>	-	WaveLinx LITE Mobile App	WaveLinx CAT Mobile App	WaveLinx Mobile App	CORE
<b>Areas</b>	-	28 per Space	Unlimited	50 per WAC2	up to 3,000
<b>Zones</b>	-	16 per Area	16 per Area	16 per Area	up to 9,000
<b>Scheduling</b>	-	-	-	Local	Global
<b>VividTune™</b>	-	-	-	Yes	Yes
<b>Plug-Load Control</b>	-	Yes	Yes	Yes	Yes
<b>Low-Voltage Power</b>	-	-	Yes	Yes	Yes
<b>Integration</b>	-	-	-	-	BACnet, API
<b>Dashboards</b>	-	-	-	-	Energy, Occupancy
<b>Configuration</b>	-	Installer	Installer	Technician	Technician / IT

## SCALABILITY

