

Project		Catalog #		Type	
Prepared by		Notes		Date	

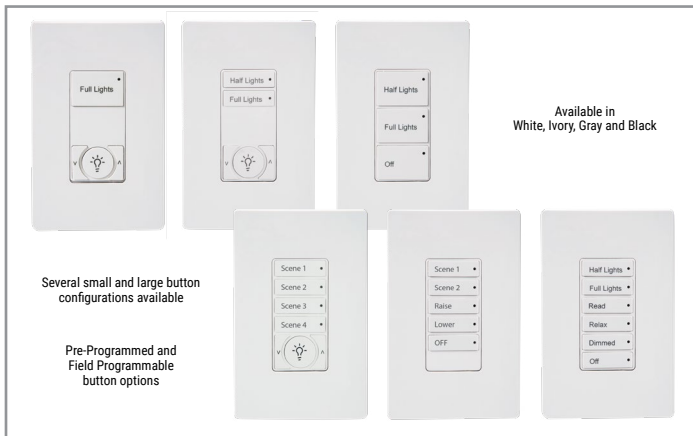

WaveLinX

PRO Wallstation (W-Series)

A wireless 120/277VAC powered wallstation with configurable button options including toggle on/off, raise lower and presets scenes and LED indicators on each button

Typical Applications

Office • Education • Healthcare • Hospitality • Retail
Industrial • Manufacturing

Interactive Menu

- Order Information pages 2 and 3
- Button Options pages 2 and 3
- Additional Resources page 5
- Connected Systems page 7
- Product Warranty

Product Certification*



- Meets latest ASHRAE Standard 90.1 requirements
- Meets latest IECC requirements
- Meets latest CEC Title 24 requirements

Product Features



Compatibility



Overview

The PRO W-Series Wallstation is a wireless, 120/277 VAC powered wallstation with configurable buttons including toggle, on/off, raise lower, preset scenes and zone light levels. Each button's actions are configurable using the WaveLinX Mobile App. Each button has a LED indicator indicating the selected scenes or light level.

The PRO W-Series Wallstation's elegant design enhances the aesthetic of a space while allowing occupants to adjust the room's brightness levels based on their sensitivity and needs.

Product Features & Benefits

- **Configurable button options** – Power toggle (on/off), raise/lower, scene and zone light level.
- **LED Indicator on each button** – Indicates the selected scene or light level
- **120/277VAC powered (neutral required)** – No battery replacement required
- **Button actions configurable via software** – Customize the actions of each button using WaveLinX Mobile Application or WaveLinX CORE Lighting App

*T24 and RoHS are self-tested by Cooper Lighting Solutions. Not a third party certification.

Order Information

The PRO W-Series wallstation communicates with other PRO devices via the WaveLinx Area Controller.

The wallstation is used to provide local and multi-level control in spaces and can be mapped to multiple zones in an area to create customizable light levels from simple control to architectural.

Catalog Number

Pre-Programmed Wallstations

Catalog Number	Description	Color Options	Button Engraving
W1L -*	WaveLinx Pro, 1 Button large wallstation	*=W - White, V - Ivory, G - Gray, B - Black	BLANK = Standard Engraving ENGRV = Customer Specified Engraving
W1L-RL -*	WaveLinx Pro, 1 Button large (RAISE/LOWER) wallstation	*=W - White, V - Ivory, G - Gray, B - Black	
W2L -*	WaveLinx Pro, 2 Button large wallstation	*=W - White, V - Ivory, G - Gray, B - Black	
W2L-RL -*	WaveLinx Pro, 2 Button large (RAISE/LOWER) wallstation	*=W - White, V - Ivory, G - Gray, B - Black	
W3L -*	WaveLinx Pro, 3 Button large wallstation	*=W - White, V - Ivory, G - Gray, B - Black	
W2S -*	WaveLinx Pro, 2 Button small wallstation	*=W - White, V - Ivory, G - Gray, B - Black	
W2S-RL -*	WaveLinx Pro, 2 Button small (RAISE/LOWER) wallstation	*=W - White, V - Ivory, G - Gray, B - Black	
W4S -*	WaveLinx Pro, 4 Button small wallstation	*=W - White, V - Ivory, G - Gray, B - Black	
W4S-RL -*	WaveLinx Pro, 4 Button small (RAISE/LOWER) wallstation	*=W - White, V - Ivory, G - Gray, B - Black	
W5S -*	WaveLinx Pro, 5 Button small wallstation	*=W - White, V - Ivory, G - Gray, B - Black	
W6S -*	WaveLinx Pro, 6 Button small wallstation	*=W - White, V - Ivory, G - Gray, B - Black	
Notes	Notes		
Field Programmable models are standard engraving options that require field programming through the WaveLinx Pro Mobile Application.	All WaveLinx Pro Wallstations include standard engraving and color matching screwless single gang wallplates. For custom engraving use the configurator tool within the FlashPro tool.		

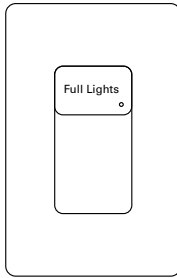

W1L-*
(* = W,V,G,B)

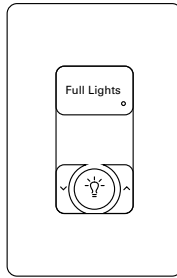

W1L-RL-*
(* = W,V,G,B)

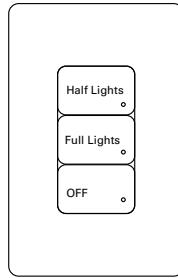

W3L-*
(* = W,V,G,B)

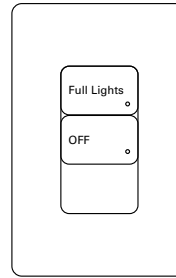

W2L-*
(* = W,V,G,B)

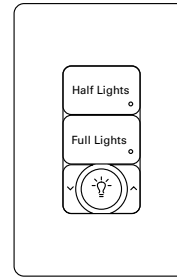

W2L-RL-*
(* = W,V,G,B)

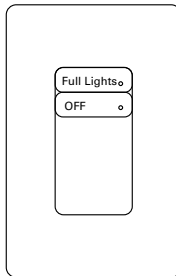

W2S-*
(* = W,V,G,B)

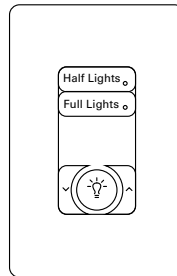

W2S-RL-*
(* = W,V,G,B)

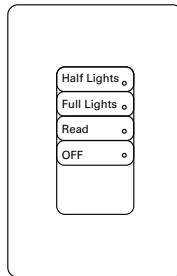

W4S-*
(* = W,V,G,B)

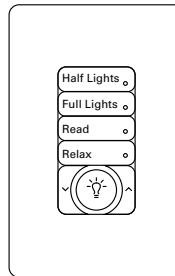

W4S-RL-*
(* = W,V,G,B)

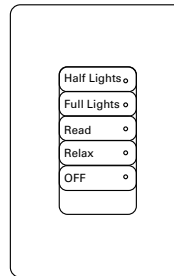

W5S-*
(* = W,V,G,B)

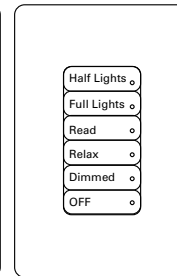

W6S-*
(* = W,V,G,B)

Default engraving & light levels

Half Lights	Scene 3 = 50%
Full Lights	Scene 1 = 100%
Read	Scene 2 = 70%
Relax	Scene 4 = 30%
Dimmed	Scene 5 = 10%
Night	Scene 6 = 1%
Off	Scene 0 = Off

ON/OFF Raise/Lower buttons



Button programming options via WaveLinx Mobile Application

- Scene Selection
- Scene Toggle
- Zone Toggle
- Zone Level
- Raise
- Lower
- HR Release
- No Action

Catalog Number

Field Programmable Wallstations

Catalog Number	Description	Color Options	Button Engraving
W1L-RL-S1-*	WaveLinx Pro, 1 Button large, field programmable (RAISE/LOWER) wallstation	*=W - White, V - Ivory, G - Gray, B - Black	BLANK = Standard Engraving ENGRV = Customer Specified Engraving
W2L-RL-S2-*	WaveLinx Pro, 2 Button large, field programmable (RAISE/LOWER) wallstation	*=W - White, V - Ivory, G - Gray, B - Black	
W2S-RL-S2-*	WaveLinx Pro, 2 Button small, field programmable (RAISE/LOWER) wallstation	*=W - White, V - Ivory, G - Gray, B - Black	
W3L-S2-*	WaveLinx Pro, 3 Button large, field programmable wallstation	*=W - White, V - Ivory, G - Gray, B - Black	
W4S-S3-*	WaveLinx Pro, 4 Button small, field programmable wallstation	*=W - White, V - Ivory, G - Gray, B - Black	
W4S-RL-S4-*	WaveLinx Pro, 4 Button small, field programmable (RAISE/LOWER) wallstation	*=W - White, V - Ivory, G - Gray, B - Black	
W5S-S4-*	WaveLinx Pro, 5 Button small, field programmable wallstation	*=W - White, V - Ivory, G - Gray, B - Black	
W5S-S2D-*	WaveLinx Pro, 5 Button small, field programmable (RAISE/LOWER) wallstation	*=W - White, V - Ivory, G - Gray, B - Black	
W6S-S3-*	WaveLinx Pro, 6 Button small, field programmable wallstation	*=W - White, V - Ivory, G - Gray, B - Black	
W6S-S3D-*	WaveLinx Pro, 6 Button small, field programmable (RAISE/LOWER) wallstation	*=W - White, V - Ivory, G - Gray, B - Black	
W6S-S5-*	WaveLinx Pro, 6 Button small, field programmable wallstation	*=W - White, V - Ivory, G - Gray, B - Black	
Notes	Notes		
Field Programmable models are standard engraving options that require field programming through the WaveLinx Pro Mobile Application.	All WaveLinx Pro Wallstations include standard engraving and color matching screwless single gang wallplates. For custom engraving use the configurator tool within the FlashPro tool.		

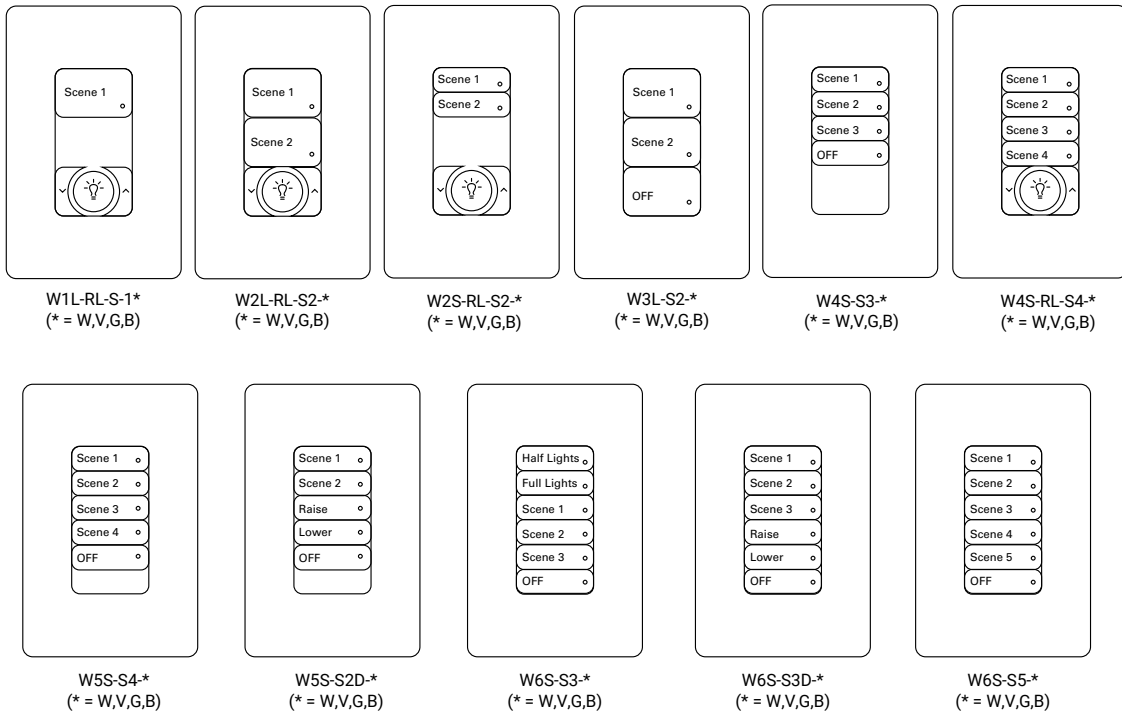

Button Kits

Catalog Number

Pre-Programmed Button Kit

Catalog Number	Description	Color Options	Button Engraving
W1L -BTS-*	WaveLinx Pro, 1 Button large wallstation - BUTTONS ONLY	*=W - White, V - Ivory, G - Gray, B - Black	BLANK = Standard Engraving ENGRV = Customer Specified Engraving
W1L-RL -BTS-*	WaveLinx Pro, 1 Button large (RAISE/LOWER) wallstation - BUTTONS ONLY	*=W - White, V - Ivory, G - Gray, B - Black	
W2L -BTS-*	WaveLinx Pro, 2 Button large wallstation - BUTTONS ONLY	*=W - White, V - Ivory, G - Gray, B - Black	
W2L-RL -BTS-*	WaveLinx Pro, 2 Button large (RAISE/LOWER) wallstation - BUTTONS ONLY	*=W - White, V - Ivory, G - Gray, B - Black	
W3L -BTS-*	WaveLinx Pro, 3 Button large wallstation - BUTTONS ONLY	*=W - White, V - Ivory, G - Gray, B - Black	
W2S -BTS-*	WaveLinx Pro, 2 Button small wallstation - BUTTONS ONLY	*=W - White, V - Ivory, G - Gray, B - Black	
W2S-RL -BTS-*	WaveLinx Pro, 2 Button small (RAISE/LOWER) wallstation - BUTTONS ONLY	*=W - White, V - Ivory, G - Gray, B - Black	
W4S -BTS-*	WaveLinx Pro, 4 Button small wallstation - BUTTONS ONLY	*=W - White, V - Ivory, G - Gray, B - Black	
W4S-RL -BTS-*	WaveLinx Pro, 4 Button small (RAISE/LOWER) wallstation - BUTTONS ONLY	*=W - White, V - Ivory, G - Gray, B - Black	
W5S -BTS-*	WaveLinx Pro, 5 Button small wallstation - BUTTONS ONLY	*=W - White, V - Ivory, G - Gray, B - Black	
W6S -BTS-*	WaveLinx Pro, 6 Button small wallstation - BUTTONS ONLY	*=W - White, V - Ivory, G - Gray, B - Black	
Notes Field Programmable models are standard engraving options that require field programming through the WaveLinx Pro Mobile Application.	Notes All WaveLinx Pro Wallstations include standard engraving and color matching screwless single gang wallplates. Buttons Only.		

Catalog Number

Field Programmable Button Kit

Catalog Number	Description	Color Options	Button Engraving
W1L -RL -S1-BTS-*	WaveLinx Pro, 1 Button large, field programmable (RAISE/LOWER) wallstation - BUTTONS ONLY	*=W - White, V - Ivory, G - Gray, B - Black	BLANK = Standard Engraving ENGRV = Customer Specified Engraving
W2L -RL -S2-BTS-*	WaveLinx Pro, 2 Button large, field programmable (RAISE/LOWER) wallstation - BUTTONS ONLY	*=W - White, V - Ivory, G - Gray, B - Black	
W2S -RL -S2-BTS-*	WaveLinx Pro, 2 Button small, field programmable (RAISE/LOWER) wallstation - BUTTONS ONLY	*=W - White, V - Ivory, G - Gray, B - Black	
W3L -S2-BTS-*	WaveLinx Pro, 3 Button large, field programmable wallstation - BUTTONS ONLY	*=W - White, V - Ivory, G - Gray, B - Black	
W4S -S3-BTS-*	WaveLinx Pro, 4 Button small, field programmable wallstation - BUTTONS ONLY	*=W - White, V - Ivory, G - Gray, B - Black	
W4S -RL -S4-BTS-*	WaveLinx Pro, 4 Button small, field programmable (RAISE/LOWER) wallstation - BUTTONS ONLY	*=W - White, V - Ivory, G - Gray, B - Black	
W5S -S4-BTS-*	WaveLinx Pro, 5 Button small, field programmable wallstation - BUTTONS ONLY	*=W - White, V - Ivory, G - Gray, B - Black	
W5S -S2D-BTS-*	WaveLinx Pro, 5 Button small, field programmable (RAISE/LOWER) wallstation - BUTTONS ONLY	*=W - White, V - Ivory, G - Gray, B - Black	
W6S -S3-BTS-*	WaveLinx Pro, 6 Button small, field programmable wallstation - BUTTONS ONLY	*=W - White, V - Ivory, G - Gray, B - Black	
W6S -S3D-BTS-*	WaveLinx Pro, 6 Button small, field programmable (RAISE/LOWER) wallstation - BUTTONS ONLY	*=W - White, V - Ivory, G - Gray, B - Black	
W6S -S5-BTS-*	WaveLinx Pro, 6 Button small, field programmable wallstation - BUTTONS ONLY	*=W - White, V - Ivory, G - Gray, B - Black	
Notes Field Programmable models are standard engraving options that require field programming through the WaveLinx Pro Mobile Application.	Notes All WaveLinx Pro Wallstations include standard engraving and color matching screwless single gang wallplates. Buttons Only.		

Required Accessories

All WaveLinx Pro connected lighting (WCL) system accessories require at least one WaveLinx Area Controller (WAC2) for communications. Ensure the bill of material includes one of the following components.

Catalog Number

Catalog Number	Description
WAC2-POE	WaveLinx Area Controller G2, PoE powered
WAC2-120	WaveLinx Area Controller G2 with 120VAC to PoE Injector

Optional Accessories

For connection to 120VAC outlets.

Catalog Number

Catalog Number	Description
WPOE2-120	120VAC to PoE Injector

Product Specifications**Mechanical**

Size: 4.75"H x 3.35"W x 1.85"D (121mm x 83mm x 47mm)

Environment:

- **Operating temperature:** 32°F to 113°F (0°C to 45°C)
- **Storage temperature:** 32°F to 167°F (0°C to 75°C)
- **Relative humidity operating:** 5% to 95% non-condensing
- For indoor use only

Mounting: Standard decorator opening

Color: White, Ivory, Gray and Black available

Electrical

Input power: 120-277VAC (neutral wire required)

Input current: 20mA (120V), 15mA (277V)

Hardware Specifications**Status Indicators:**

- Button LEDs - White (1 per scene button)
- LED functionality
 - Indication of wireless network join request
 - Indication of wireless network connection
 - Scene indication of operations

Button Configuration:

- Large buttons 1-3
- Small buttons 2,4,5,6

Software Specifications

- Each button programmable to trigger or toggle Scene or Zone
- Default values when joined to an area via WaveLinx Pro Mobile Application
- Models available with dominant button 50% light level
- Fade rates and scene transitions are programmable

Wireless Specifications

Radio: 2.4GHz

Standard: IEEE 802.15.4

Transmitter Power: + 7dBm

Configuration type: Router, End Point

Range: 150ft (50m) LOS through 2 interior walls of standard construction

Note - metal faceplates will reduce wireless range

System Performance

Maximum number of Devices: 200 per WaveLinx Area Controller (best practice 150 devices)

Standards/Ratings*

- cULus Certified
- FCC Part 15
- Meets latest ASHRAE Standard 90.1 requirements
- Meets latest IECC requirements
- Meets latest CEC Title 24 requirements

Warranty

Five year warranty standard

Note: Use of ammonia based or VOC cleaners on this device must be avoided. Prolonged use may cause loss of integrity and expose electrified components. If this occurs, turn OFF power to the unit and replace.



Download the WaveLinx Pro Mobile Application from either the Google Play or Apple Store®

*T24 and RoHS are self-tested by Cooper Lighting Solutions. Not a third party certification.

Dimensional Details

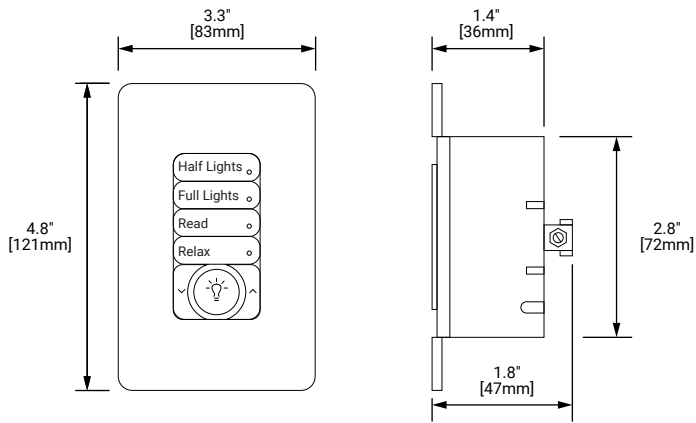

Mounting Height

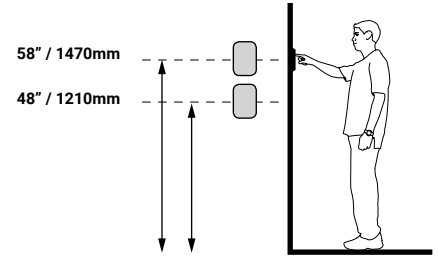

Installation

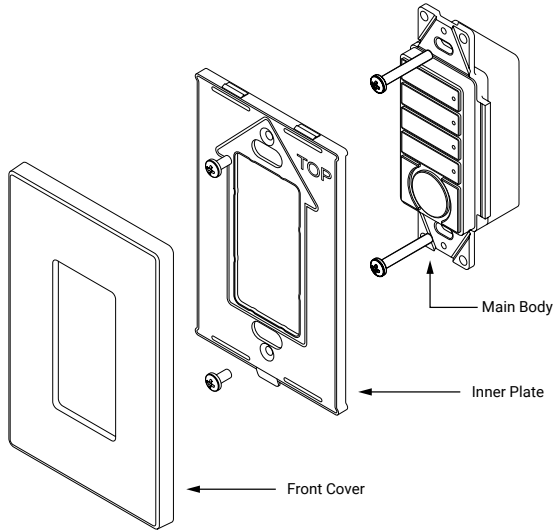

System Diagram:

This diagram shows the main components of the WaveLinX connected lighting system with CAT and PRO devices.

The PRO devices communicate using wireless mesh technology based on the IEEE 802.15.4 standard. A PoE LAN connection for each WaveLinX Area Controller (WAC) is required for power and data access to the building lighting network.

The CAT devices communicate over the category 5 based communication bus and control the light fixtures using a relay (on/off) and 0-10V output (dim/raise).

WaveLinX Area Controllers (WAC) communicate with WaveLinX CORE Apps over the Ethernet network.

[View WaveLinX Network and IT Guidance Technical Guide](#)

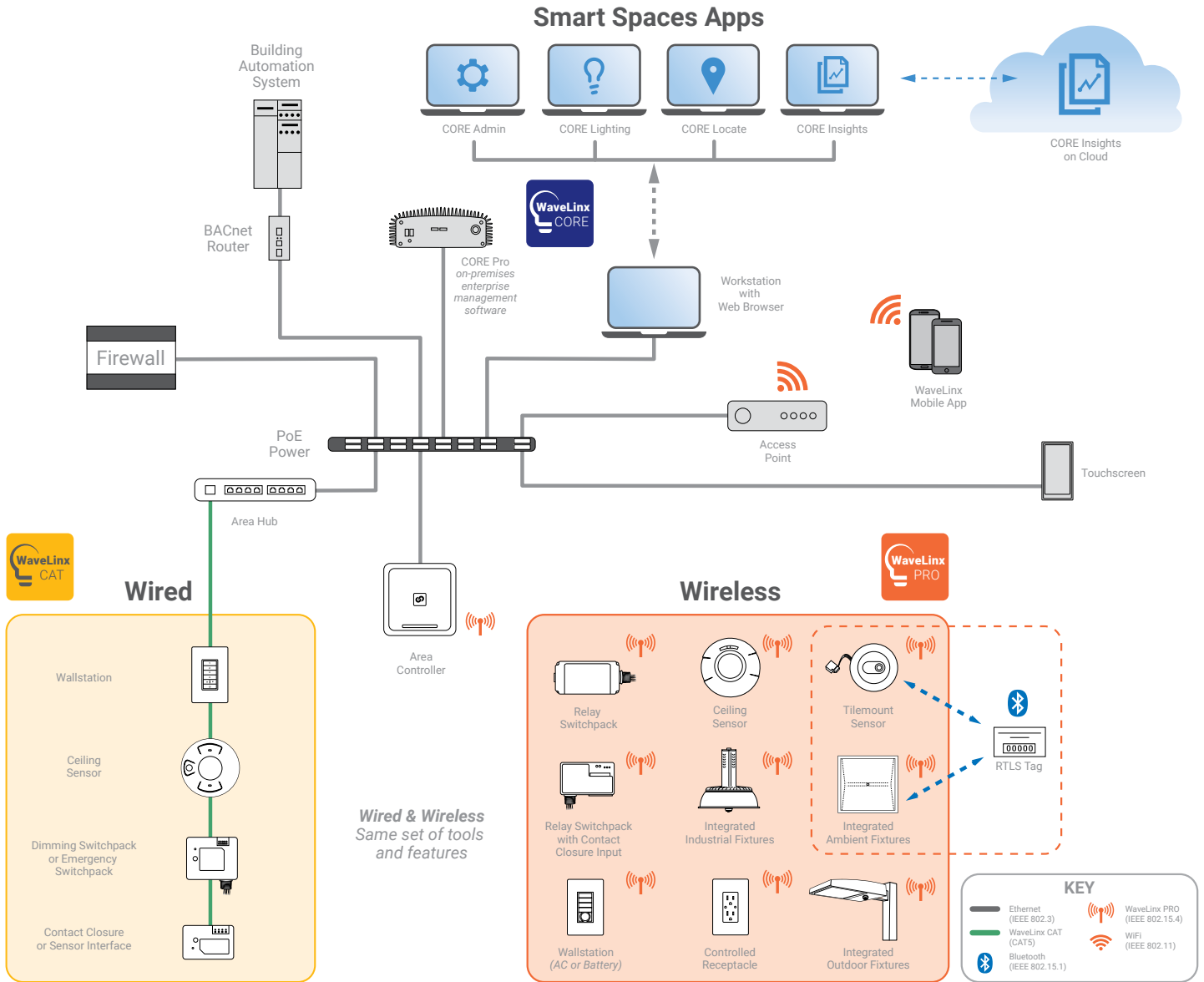

Control Systems
• WaveLinX