

Project		Catalog #		Type	
Prepared by		Notes		Date	



# Metalux

## Cruze ST 24CZ2

2' x 4' LED Specification Grade Troffer

### Typical Applications

Office • Education • Healthcare • Hospitality • Retail

### Product Certification



### Product Features



### Interactive Menu

- Order Information page 2
- Photometric Data page 3
- Control Solutions page 5
- VividTune™ Color Tuning Solutions page 6
- BioUp - Melanopic Lighting page 7
- Product Warranty

### Top Product Features

- Latch-less design provides clean architectural look
- BioUp melanopic lighting options for 30% circadian boost and earn WELL Building Standard points
- VividTune CCT tuning options from 3000K-5000K or 2700K-6500K
- Designers delight - ribbed, smooth and round perforated lens options
- High performance efficacy up to 167 lm/W
- Integrated sensor systems - occupancy, daylight and IoT connectivity
- Options to meet Buy American and other domestic preference requirements

### Dimensional and Mounting Details

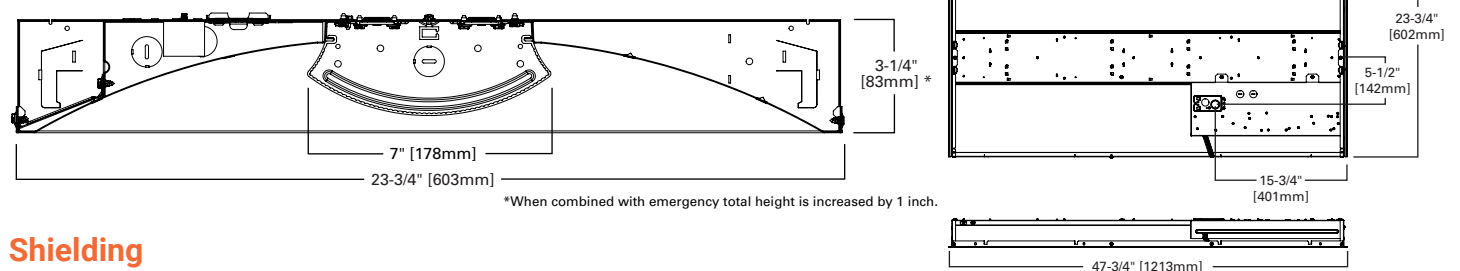

### Shielding



See ordering information for more shielding options.



SQR - Square Ribbed Frosted Acrylic Lens

### Ceiling Compatibility

G	G	G	Ceiling Type	Trim Type
Grid/Lay-in Standard	Concealed T	Slot Grid	Exposed Grid	Standard
			Concealed T	Standard
			Slot Grid	Standard
			Flange	*

\*See Drywall Frame Kit Accessory in Ordering Information Section

## Order Information

SAMPLE ORDER NUMBER: **24CZ2-45HE-UNV-L835-CD1-U**

Domestic Preferences <sup>(1)</sup>	Rating	Series	Air	Lumen Level / Efficacy Option		
<b>[Blank]</b> =Standard <b>BAA</b> =Buy American Act <b>TAA</b> =Trade Agreements Act	<b>[Blank]</b> =Standard <b>ATW-SW4</b> =Chicago Rated	<b>24CZ2-2x4</b> Cruze ST	<b>[Blank]</b> =Standard <b>A</b> =Air (Vented) <sup>(2)</sup>	<b>Standard [Blank]</b> <b>30</b> =3000 Lumens <b>35</b> =3500 Lumens <b>40</b> =4000 Lumens <b>45</b> =4500 Lumens <b>50</b> =5000 Lumens <b>55</b> =5500 Lumens <b>60</b> =6000 Lumens <sup>(3)</sup> <b>65</b> =6500 Lumens <sup>(3),(4)</sup>	<b>High Efficacy [HE]</b> <b>30HE</b> =3000 Lumens <b>35HE</b> =3500 Lumens <b>40HE</b> =4000 Lumens <b>45HE</b> =4500 Lumens <b>50HE</b> =5000 Lumens <b>55HE</b> =5500 Lumens <b>60HE</b> =6000 Lumens <sup>(4)</sup> <b>65HE</b> =6500 Lumens <sup>(4),(6)</sup> <b>70HE</b> =7000 Lumens <sup>(4),(6)</sup> <b>75HE</b> =7500 Lumens <sup>(3),(4)</sup>	<b>Very High Efficacy [VHE]</b> <b>30VHE</b> =3000 Lumens <sup>(5)</sup> <b>35VHE</b> =3500 Lumens <sup>(5)</sup> <b>40VHE</b> =4000 Lumens <sup>(5)</sup> <b>45VHE</b> =4500 Lumens <sup>(5)</sup> <b>50VHE</b> =5000 Lumens <sup>(5)</sup> <b>55VHE</b> =5500 Lumens <sup>(5)</sup> <b>60VHE</b> =6000 Lumens <sup>(5)</sup> <b>65VHE</b> =6500 Lumens <sup>(3),(4)</sup> <b>70VHE</b> =7000 Lumens <sup>(3),(4)</sup> <b>75VHE</b> =7500 Lumens <sup>(3),(4)</sup> <b>80VHE</b> =8000 Lumens <sup>(3),(4)</sup> <b>85VHE</b> =8500 Lumens <sup>(3),(4)</sup> <b>90VHE</b> =9000 Lumens <sup>(3),(4)</sup> <b>95VHE</b> =9500 Lumens <sup>(3),(4)</sup> <b>100VHE</b> =10000 Lumens <sup>(3),(4),(5)</sup> <b>110VHE</b> =11000 Lumens <sup>(3),(4),(5)</sup> <b>120VHE</b> =12000 Lumens <sup>(3),(4),(5)</sup> <b>130VHE</b> =13000 Lumens <sup>(3),(4),(5)</sup> <b>150VHE</b> =15000 Lumens <sup>(3),(4),(5)</sup> <b>170VHE</b> =17000 Lumens <sup>(3),(4),(5)</sup>
<b>Notes</b> (1) Only product configurations with these designated prefixes are built to be compliant with the Buy American Act of 1933 (BAA) or Trade Agreements Act of 1979 (TAA), respectively. Please refer to <a href="#">DOMESTIC PREFERENCES</a> website for more information. Components shipped separately may be separately analyzed under domestic preference requirements.		<b>Notes</b> (2) Air version is intended for air return through plenum. See air return data table for air flow volumes. Air option not available with ATW-SW4. Air requires "PAF" option.		<b>Notes</b> (3) VividTune white tuning and BioUp static and dynamic options are not available with these lumen/efficacy selections. (4) Available with CD or HCD drivers only. (5) Requires 2 CD-1 drivers above 100VHE. (6) W2D Dali dimming BioUp not available with these options.		

Shielding	Voltage <sup>(7)</sup>	Options	Emergency Options
<b>[Blank]</b> =Ribbed Frosted Acrylic Lens (standard) <b>S</b> =Smooth Frosted Acrylic Lens <b>HRP</b> =High-Efficiency Round Perf Inlay Frosted Acrylic Lens <b>SQR</b> =Square Ribbed	<b>UNV</b> =Universal Voltage 120-277 <b>347V</b> =347 Volt <sup>(8)</sup>	<b>GL</b> =Single Element Fuse <b>GM</b> =Double Element Fuse <b>PAF</b> = Painted After Fabrication	<b>[Blank]</b> =No emergency <b>EL7W</b> =7-watt 120V-277V emergency battery pack <sup>(9)</sup> <b>EL10W</b> =10-watt 120V-277V emergency battery pack <sup>(9)</sup> <b>EL14W</b> =14-watt 120V-277V emergency battery pack <sup>(9)</sup> <b>EL10WSD</b> =10W emergency battery pack with self-diagnostic installed <sup>(9),(11)</sup> <b>EL14WSD</b> =14W emergency battery pack with self-diagnostic installed <sup>(9),(11)</sup> <b>ETRD</b> =Emergency Transfer Relay with dimming control <sup>(10)</sup> <b>RRU</b> =LVS Controls Emergency Transfer Relay with dimming control <sup>(10)</sup> <b>UEL7W</b> =UL924 Listed luminaire, 7-watt, 120V-277V emergency battery pack <sup>(13),(9)</sup> <b>UEL14W</b> =UL924 Listed luminaire, 14-watt 120V-277V emergency battery pack <sup>(13),(9)</sup> <b>UEL10WSD</b> =Bodine 10W emergency battery pack with self diagnostic installed <sup>(13),(9),(12)</sup> <b>UETRD</b> =UL924 Listed luminaire, Emergency Transfer Relay with dimming control <sup>(13),(10)</sup> <b>URRU</b> =UL924 Listed luminaire, LVS Controls Emergency Transfer Relay with dimming control <sup>(13),(10)</sup>
<b>Notes</b> (7) Products also available in non-US voltages and frequencies for international markets. (8) Some 347V versions require a transformer. Total wattage will increase by 2 watts if used.		<b>Notes</b> (9) Factory installed with integral test switch/indicator/laser test. For approximate delivered lumens multiply the lumens per watt of the desired fixture by the wattage of the emergency battery pack (100 lm/W x 7=700 lumens). IES-format photometry for luminaire under emergency operation available. Battery option increases total height by 1 inch. (10) Used to bypass local control during outage. Must be used in conjunction with UL 1008 device (provided by others). Devices are universal voltage (UNV). 347 not available. (11) EL10WSD and EL14WSD not available with 347V. (12) UEL10WSD not available with 347V. (13) Cannot be used with BioUp options.	

CRI/CCT	Flex	Driver Type
<b>L830</b> =80CRI, 3000K <b>L835</b> =80CRI, 3500K <b>L840</b> =80CRI, 4000K <b>L850</b> =80CRI, 5000K <b>L930</b> =90CRI, 3000K <b>L935</b> =90CRI, 3500K <b>L940</b> =90CRI, 4000K <b>L950</b> =90CRI, 5000K <b>L83050</b> =80CRI 3000K-5000K White Tuning <sup>(15)</sup> <b>L93050</b> =90CRI 3000K-5000K White Tuning <sup>(15)</sup> <b>L82765</b> =80CRI 2700K-6500K White Tuning <sup>(15)</sup> <b>L92765</b> =90CRI 2700K-6500K White Tuning <sup>(15)</sup> <b>B35</b> =BioUp Static 3500K <sup>(16)</sup> <b>B40</b> =BioUp Static 4000K <sup>(16)</sup> <b>B50</b> =BioUp Static 5000K <sup>(16)</sup> <b>B2750</b> =BioUp Tunable 2700K-5000K <sup>(17)</sup>	<b>[Blank]</b> =No Flex <b>A3/8-4/18GDIM</b> =3/8" Flex with 0-10V Dimming Leads <b>A3/8-2/18G</b> =3/8" Flex with line and common <b>A3/8-5/18GDIM</b> =Flex with 0-10V Dimming leads and Blue for alternate wiring. See below for details. <b>Flexible Metal Conduit Options</b> Flex options available for 0-10V dimming control, DALI dimming control, emergency and night light functions. 72-inch factory-installed and pre-wired to driver, fitted to luminaire housing access plate with 90° enclosed FMC connector. Not all options may be combined and installation ratings vary by type. See online configurator for all flex options. <b>A3/8-4/18GDIM series notes:</b> Factory installed dimming option 3/8" flexible metal conduit with 2-#18 power and ground wires and 2-#18 UL-listed jacketed 0-10V +/- control wires. Meets UL 66, 83, 1479, 1569, 1581, 2556. NEC® 250.118, 300.22(C), 392, 396, 330, 501, 502, 503, 504, 505, 518, 520, 530, 645, 72; Federal Specification A-A-59544 (formerly J-C-308); all applicable OSHA and HUD Requirements. UL Classified 1-, 2-, and 3-hour through penetration with applicable fire stop product (not included). May be surface mounted, fished and/or embedded in plaster. Cable tray and approved raceway rated, install per NEC®; Environmental Air-Handling Space Installation per NEC® 300.22(C).	<b>CD</b> =0-10V Driver (10%-100% Dimming) <sup>(26)</sup> <b>HCD</b> =0-10V Driver (1%-100% Dimming) <sup>(26)</sup> <b>5LTD</b> =DALI Driver (5%-100% Dimming) <b>5LTHD</b> =DALI Driver (1%-100% Dimming) <b>SD</b> =Step Dimming Driver (50%-100% Dimming) <b>LH</b> =Lutron HiLume 1% EcoSystems (LDE1) <sup>(5)</sup> <b>W2A</b> =White Tuning, 2 ch, Analog 0-10V (1%-100% Dimming) <sup>(18),(26)</sup> <b>W2D</b> =White Tuning, 2 ch, DALI Type 8 (1%-100% Dimming) <sup>(19)</sup>
<b>Notes</b> (15) VividTune provides correlated color temperatures (CCT) between 3000K (warm) to 5000K (cool) or 2700K (warm) to 6500K (cool). Must be used in conjunction with W2A driver only. Must be used with two (2) 10V dimming control channels, 1 cct, 1 intensity. May be combined with Wavelinx sensor control systems. (16) BioUp Static to be used with HCD driver. (17) BioUp Tunable provides correlated color temperatures (CCT) between 2700K (warm) to 5000K (cool). Must be used with W2A (for two channel 0-10V Control) or W2D (for 2 channel Dali Control) driver. See BioUp page for more information.	<b>Notes</b> (18) W2A used with two (2) 10V dimming control channels - cct and intensity. (19) W2D for use with BioUp options only. White tuning CCT between 2700K and 5000K. Must be used with DALI controls; one address to control two channels - intensity and CCT. May not be used with sensing systems. For Emergency options ONLY EL10WSD can be used. (26) When selecting 0-10V driver with integrated Sensing System a 0-10V driver might be substituted with another type. Integrated options must be used in conjunction with the associated system and may not be compatible with other options or accessories. Please refer to the following: (F) Consult Marketplace Options - Lutron system pages for additional details and compatibility. Compatible only with driver series shown, and may require two or more drivers. Requires field commissioning to operate or dim. Contact Lutron at www.lutron.com.	

## Order Information

CONTINUED

Number of Drivers	Integrated Sensing Systems <sup>(21)</sup>	Packaging	Accessories (order separately) <sup>(25)</sup>
1=1 Driver 2=2 Drivers <sup>(20)</sup>	<b>[Blank]</b> =No Sensor <b>WLS (formerly WAB)</b> =WaveLinX LITE Wireless Sensor, Occupancy w/ photocell, Independent & Networked <sup>(23),(B)</sup> <b>WPS (formerly WAA)</b> =WaveLinX PRO Wireless Sensor, Occupancy w/ photocell, Networked <sup>(22),(A)</sup> <b>WLN</b> =WaveLinX LITE Wireless Control Node, without sensor <sup>(23),(B)</sup> <b>WPN</b> =WaveLinX PRO Wireless Control Node, without sensor <sup>(22),(A)</sup>	<b>U</b> =Unit Pack <b>PAL</b> =Job Pack, out of carton <b>PALC</b> =Job Pack, in carton	<b>CZ2-EQCLIP-U-PK</b> =“CZ2” Earthquake Clip Kit (4 clips per bag kit) <sup>(24)</sup> <b>DF-24W-U</b> =2' x 4' Drywall Frame Kit <b>SK-24-WS</b> =2' x 4' Shallow Surface Mount Kit <b>SK-24-WT</b> =2' x 4' Tall Surface Mount Kit
<b>Notes</b> <small>(20) See lumen limitation notes for applications requiring 2 drivers or use online configurator. When combined with emergency total height is increased by 1 inch.</small>	<b>Notes</b> <small>(21) Matching width lens band on other side of sensor band may be supplied for symmetrical appearance. Required for use with sensor and emergency combination. Add "D" to sensor ordering as shown - WPSD, WLS.D. (22) WPS sensor and WPN node to be used with CD, HCD or W2A driver. (23) WLS Sensor and WLN node to be used with CD or HCD driver. Integrated options must be used in conjunction with the associated system and may not be compatible with other options or accessories. Please refer to the following: (A) Consult WaveLinX PRO system pages for additional details and compatibility. (B) Consult WaveLinX LITE system pages for additional details and compatibility.</small>		<b>Notes</b> <small>(24) An EQ Grid Clip is recommended for all 9/16" ceiling systems. Four required per fixture. (25) Accessories sold separately will be separately analyzed under domestic preference requirements. Consult factory for further information.</small>

## Product Specifications

### Construction

- Die formed of code gauge prime cold rolled steel with full length die-formed stiffeners
- Unibody endplates attached with interlocking tabs and screws
- Hemmed side flanges
- Four auxiliary fixture end suspension points
- Integral Grid-lock feature for endplates for added safety
- Optional earthquake clips available

### Integrated Controls

- Standard with 0-10V dimming driver (10% standard, 1% optional)
- Integrated WaveLinX options provide wireless individual fixture control and enable code compliance, increased energy savings, grouping of fixtures, and connection to WaveLinX control systems
- DALI 2.0, Lutron, and step-dimming available

### LED and Light Engine

- LED's available in 3000K, 3500K, 4000K, or 5000K at 80 CRI minimum and 90 CRI minimum
- Color accuracy  $\leq 3$ -Step MacAdam ellipse (SDCM)
- TM21 life at 60,000 hours up to L90 and calculated L70 exceeds 203,000 hrs.
- Drivers available in 120-277V and 347V
- Tunable white options available with Cooper Lighting Solutions' VividTune
- BioUp melanopic lighting options available in static or tunable white

### Emergency Options

- 120V-277V integral emergency battery pack comes in 7-watts, 10-watt, or 14-watts
- Self-diagnostic emergency battery available in 10 or watts (NFPA 101® Life Safety Code®)
- Constant power to the LED system for controlled, predictable discharge
- Integrated test switch/indicator light visible from floor
- Min. 90-minute backup period for code compliance
- Integral emergency transfer relay available for generator equipped power systems

### Shielding

- Ribbed acrylic frosted lens standard
- Optional smooth acrylic frosted lens (S)
- Optional square ribbed frosted acrylic lens (SQR)
- Optional High-Efficiency Round Perf Inlay (HRP)
- Replacement lenses available, contact factory
- Lens is acrylic with features on the face and sides to optimize the direct and indirect lighting contributions for improved glare and efficacy

### Compliance

- IC rated for insulation contact
- cULus listed for damp locations
- UL924 luminaire listing available, see Emergency Options
- RoHS compliant
- Tested to IESNA LM-79 and LM-80
- Stated life tested to TM21 standards
- Can be used for State of California Title 24 high efficacy luminaire

### Warranty

- Five-year limited warranty standard. Optional ten year limited warranty available.

### Finish

- Multistage, iron phosphate pretreatment
- 90% reflective, matte white enamel finish
- Full fixture housing pre-painted matte white (choose PAF option for "Paint after Fabrication")

## Photometric Data

 [View IES files](#)

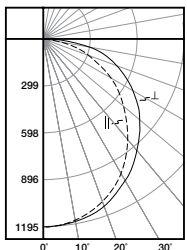

**24CZ2-35-UNV-L830-CD1-U**  
Dimming Driver  
Linear LED 3000K  
Spacing criterion: (II) 1.22 x mounting height,  
(I) 1.28 x mounting height  
Lumens: 3618  
Input Watts: 30.1W  
Efficacy: 120.2 LPW  
Test Report: 24CZ2-35-UNV-L830-CD1-U.IES

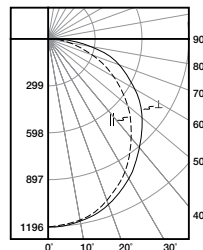

**24CZ2-35HE-UNV-L830-CD1-U**  
Dimming Driver  
Linear LED 3000K  
Spacing criterion: (II) 1.21 x mounting height,  
(I) 1.27 x mounting height  
Lumens: 3562  
Input Watts: 26.9W  
Efficacy: 132.4 LPW  
Test Report: 24CZ2-35HE-UNV-L830-CD1-U.IES

## Energy and Performance Data

### Standard Efficacy Versions – Single Row of LEDs Default CCT/Lumen Setting: 3500K/Med

Catalog Number	Lumens	Watts	lm/W
24CZ2-30-UNV-L835-CD1-U	3028	22.4	135
24CZ2-35-UNV-L835-CD1-U	3633	27.3	133
24CZ2-40-UNV-L835-CD1-U	4178	30.4	137
24CZ2-45-UNV-L835-CD1-U	4602	35.0	132
24CZ2-50-UNV-L835-CD1-U	5049	39.6	128
24CZ2-55-UNV-L835-CD1-U	5571	41.1	135
24CZ2-60-UNV-L835-CD1-U	6056	46.3	131
24CZ2-65-UNV-L835-CD1-U	6601	50.1	132

### High Efficacy Versions – Two Rows of LEDs Default CCT/Lumen Setting: 3500K/Med

Catalog Number	Lumens	Watts	lm/W
24CZ2-30HE-UNV-L835-CD1-U	3100	22.3	139
24CZ2-35HE-UNV-L835-CD1-U	3685	27.0	137
24CZ2-40HE-UNV-L835-CD1-U	4144	30.7	135
24CZ2-45HE-UNV-L835-CD1-U	4712	35.3	134
24CZ2-50HE-UNV-L835-CD1-U	5164	38.6	134
24CZ2-55HE-UNV-L835-CD1-U	5722	43.5	132
24CZ2-60HE-UNV-L835-CD1-U	6182	44.1	140
24CZ2-65HE-UNV-L835-CD1-U	6777	48.9	139
24CZ2-70HE-UNV-L835-CD1-U	7218	49.3	146
24CZ2-75HE-UNV-L835-CD1-U	7787	55.4	141

### Very High Efficacy Versions – Three Rows of LEDs Default CCT/Lumen Setting: 3500K/Med

Catalog Number	Lumens	Watts	lm/W
24CZ2-30VHE-UNV-L835-CD1-U	3011	20.4	148
24CZ2-35VHE-UNV-L835-CD1-U	3526	22.8	155
24CZ2-40VHE-UNV-L835-CD1-U	4042	26.2	154
24CZ2-45VHE-UNV-L835-CD1-U	4559	29.6	154
24CZ2-50VHE-UNV-L835-CD1-U	5064	32.7	155
24CZ2-55VHE-UNV-L835-CD1-U	5570	36.1	154
24CZ2-60VHE-UNV-L835-CD1-U	6055	38.7	157
24CZ2-65VHE-UNV-L835-CD1-U	6565	42.2	156
24CZ2-70VHE-UNV-L835-CD1-U	7059	45.7	155
24CZ2-75VHE-UNV-L835-CD1-U	7662	49.9	154
24CZ2-80VHE-UNV-L835-CD1-U	8128	53.8	151
24CZ2-85VHE-UNV-L835-CD1-U	8600	57.9	149
24CZ2-90VHE-UNV-L835-CD1-U	9053	61.8	147
24CZ2-95VHE-UNV-L835-CD1-U	9521	65.6	145
24CZ2-100VHE-UNV-L835-CD1-U	10191	69.6	146
24CZ2-110VHE-UNV-L835-CD2-U	11098	77.4	143
24CZ2-120VHE-UNV-L835-CD2-U	12211	83.6	146
24CZ2-130VHE-UNV-L835-CD2-U	13271	90.7	146
24CZ2-150VHE-UNV-L835-CD2-U	15006	104.2	144
24CZ2-170VHE-UNV-L835-CD2-U	17021	123.4	138

### Shielding

Lumen Adjustment Factors		
S	HRP	SQR
1.05	0.81	0.96

### Lumen Calculator

CCT Multiplier	80 CRI	90 CRI <sup>(1)</sup>	BioUp Static
3000K	0.965	0.827	-
3500K	1.000	0.847	0.912
4000K	1.019	0.856	0.899
5000K	1.019	0.909	0.879

Notes: (1) Input wattages for 90 CRI versions may vary. Refer to published IES-format photometry or LM-79 reports for more details.

### Example of Lumen Adjustment Calculation

24CZ2-40-UNV-L835-CD1-U at 90CRI at 3500K

Lumen Adjustment Factor = 0.845

Total Light Output =

4,196 lm x 0.845 = 3,546 lm

Efficacy = 3,546 lm = 98 lm/W  
36.2W

### Lumen Maintenance

Version	TM-21 Lumen Maintenance (60,000 hours) <sup>(2)</sup>	Theoretical L70 (Hours) <sup>(3)</sup>
Standard	> 87%	> 151,000
High Efficiency	> 90%	> 203,000
Very High Efficiency	> 90%	> 203,000

Notes: (2) Supported by IES TM-21 standards. (3) Theoretical values represent estimations commonly used; however, refer to the IES position on LED Product Lifetime Prediction, IES PS-10-18, that explains proper use of IES TM-21 and LM-80.

### Load Data (Stock Product)

Thd	6%
Power Factor	0.99
Weight (lbs.)	16
Low Temp. Start	-20°C

### Shipping Data

Catalog No.	Wt.	Pallet 49"L x 52"W x 46"H
2' x 4'	20.4 lbs.	28

### Air Return Volume

Negative Static Pressure (Inches H <sub>2</sub> O)	Return Air Volume (CFM)
0.05	75
0.1	103
0.2	153
0.25	177
0.3	191
0.45	234

## Control Solutions

- WaveLinX LITE wireless
- WaveLinX PRO wireless
- WaveLinX CAT wired
- WaveLinX Wired



The Cruze ST with WaveLinX offers no-hassle lighting control with multiple luminaire level control solutions.



**WaveLinX PRO** is a wireless lighting control solution, for connected spaces, that significantly reduces a building's energy consumption. From a single floor to an entire campus, WaveLinX PRO connects more than lighting assets; it shares aggregated sensor data with the WaveLinX CORE platform and other building systems, so building owners can improve operations, spaces environment, and tenants' experience. WaveLinX PRO offers a rich portfolio of wireless devices, WaveLinX PRO-enabled luminaires, and an intuitive WaveLinX mobile app for office, education, warehouse, and parking garage applications.



**WaveLinX LITE** is a cost effective, wireless digital lighting control solution, with out-of-the-box functionality, that saves energy and meets code. It's designed for applications that require occupancy-based, daylighting, or manual light control. Customize installations for office, education, warehouse and parking garages using the secure, simple mobile app.

### Integrated Sensor Coverage Pattern

TOP VIEW:

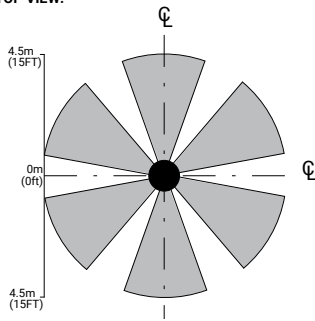

SIDE VIEW:

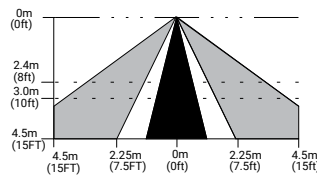

**Note:** Installation of integrated sensors within 3-ft (1m) of HVAC air vents is not recommended. The pattern shown is intended solely as a general guide and is not to scale.

With Integrated WaveLinX Sensor

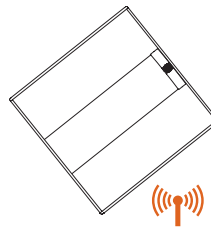

With Integrated WaveLinX Node

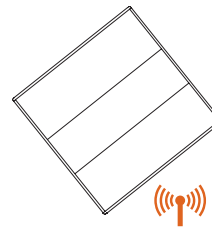

Add a hidden WaveLinX sensor node (WPN, WLN) to your space lighting design!

Allows to:

- Keeps luminaire aesthetics
- Connect fixtures without the realestate to include sensor option such as downlights
- Connect sealed fixtures without a standard sensor option such as products for clinical space.

### Integrated Controls Options

Option	Out of the Box Functionality	Luminaire Level Lighting Control (LLC)	Automatic Dimming Photocell	Occupancy Sensing	CCT Control
WLS	X	X	X	X	
WLN		X			
WPS		X	X	X	X
WPN		X			X

**Note:** WaveLinX utilizes scenes to allow users to change an area's fixtures Correlated Color Temperature (CCT) and intensity using commissioned manual wireless wallstation scene control. To enable CCT adjustments through WaveLinX, include WPS or WPN devices in addition to VividTune or BioUp technologies for integrated fixture control.

## Systems comparison chart

Cooper Lighting Solutions provides many lighting system solutions designed to satisfy code requirements and meet the unique needs of any project.



**Luminaire with standalone sensor**

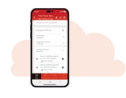

**Standalone Spaces WaveLinX LITE**



**Standalone Spaces WaveLinX CAT**



**Networked Spaces WaveLinX PRO**



**Enterprise WaveLinX CORE**

	Luminaire with standalone sensor	Standalone Spaces WaveLinX LITE	Standalone Spaces WaveLinX CAT	Networked Spaces WaveLinX PRO	Enterprise WaveLinX CORE
<b>Occupancy</b>	Yes	Yes	Yes	Yes	Yes
<b>Daylighting</b>	Yes	Yes	Yes	Yes	Yes
<b>Wallstations</b>	-	Yes	Yes	Yes	Yes
<b>Gateways</b>	-	-	-	1 WAC	300 WACs
<b>Devices (MAX)</b>	-	40 per Area (1120 per space)	40 per Area	200 per WAC2	32,500 per CORE Enterprise
<b>Software</b>	-	WaveLinX LITE Mobile App	WaveLinX CAT Mobile App	WaveLinX Mobile App	CORE
<b>Areas</b>	-	28 per Space	Unlimited	50 per WAC2	up to 3,000
<b>Zones</b>	-	16 per Area	16 per Area	16 per Area	up to 9,000
<b>Scheduling</b>	-	-	-	Local	Global
<b>VividTune™</b>	-	-	-	Yes	Yes
<b>Plug-Load Control</b>	-	Yes	Yes	Yes	Yes
<b>Low-Voltage Power</b>	-	-	Yes	Yes	Yes
<b>Integration</b>	-	-	-	-	BACnet, API
<b>Dashboards</b>	-	-	-	-	Energy, Occupancy
<b>Configuration</b>	-	Installer	Installer	Technician	Technician / IT



**24 Cruze ST LED with VividTune Tunable White**

VividTune tunable white luminaires from Cooper Lighting Solutions deliver high-quality light in a broad range of continuously variable color temperatures and intensities. Create a dynamic environment by adjusting the ambient light warmer or cooler to influence mood, support the task at hand, or create a dramatic ambience. The ability to control correlated color temperature and intensity separately using simple controls is the next evolution of LED lighting for the commercial, educational, healthcare and hospitality space. The unparalleled flexibility and number of available lighting environments enable users to find the right light with tunable white.

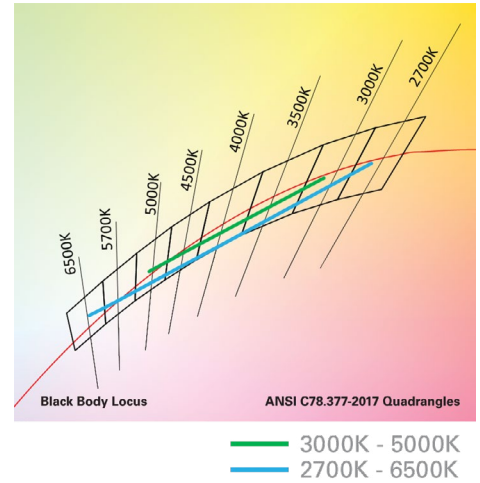

**Energy and Performance Data**

Tunable White - Lumen Adjustment Factors						
CCT	VividTune 3000K-5000K		VividTune 2700K-6500K		BioUp Tunable White 2700K-5000K	
	80 CRI	90 CRI	80 CRI	90 CRI	CRI	Lumen Adjustment
2700K	-	-	0.903	0.771	95	0.938
3000K	0.929	0.765	0.928	0.801	94	0.929
3500K	0.983	0.836	0.961	0.842	90	0.912
4000K	1.033	0.903	0.981	0.868	87	0.899
4500K	1.042	0.918	0.999	0.891	85	0.890
5000K	1.042	0.918	1.013	0.909	84	0.879
6500K	-	-	1.028	0.933	-	-

2' x 4' Cruze ST LED - Example of Approximate Lumen Calculation				
	Standard Catalog #	VividTune 80 CRI Catalog #	VividTune 90 CRI Catalog #	BioUp Tunable White
CCT Setting	24CZ2-40HE-UNV-L835-CD1-U	24CZ2-40HE-UNV-L83050-W2A1-U	24CZ2-40HE-UNV-L93050-W2A1-U	24CZ2-40HE-UNV-B2750-W2A1-U
2700K	-	3638	3106	3779
3000K	-	3641	2998	3743
3500K	4029	3853	3275	3674
4000K	-	4046	3537	3622
4500K	-	4084	3599	3586
5000K	-	4084	3599	3541
6500K	-	4142	3579	-

**Controlling VividTune and BioUp Tunable White**

From wall dimmers to wireless controls, tunable white luminaires are compatible with industry standard 0-10V and DALI controls. One channel to control intensity (brightness) and a second channel to adjust CCT.

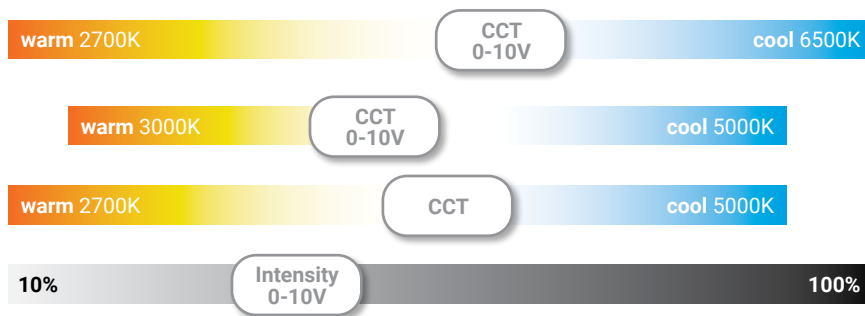

**Example of Lumen Adjustment Calculation**

24CZ2-40HE-UNV-L83050-W2A1-U at 80 CRI tuned to 3500K

Adjusted Lumen = published lm x adjusted lm factor

Adjusted Lumen = 4029 x 0.956

Adjusted Lumen = 3853 lm

\* Lumen adjustment factors are for reference and may be different for each product selected. Refer to IES files for actual performance data on each.

# Proven Research. Industry Recognized.

## BioUp

Melanopic Lighting



See better



Feel better



Function better

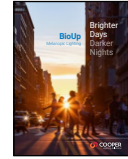

See [BioUp brochure](#) for more details

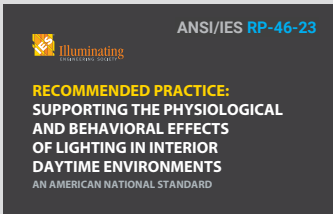

ANSI/IES RP-46-23 / TM18 published March 2024 based on over 40 years of research.

"...circadian clock synchronization is paramount to the body's efficient and appropriate functioning." – TM18



BioUp solutions maximize WELL points for Circadian Lighting Design (L03):

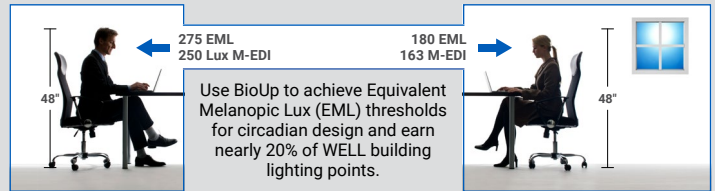

**MDER, M-EDI** and **EML** are key metrics used to quantify non-visual performance of indoor lighting systems.

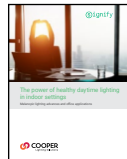

See [BioUp white paper](#) for more details

**MDER** - Melanopic Daylight Efficacy Ratio (MDER) measures the amount of light stimulating to the melanopsin receptors.

**Standard 4000K LED**  
MDER = .62

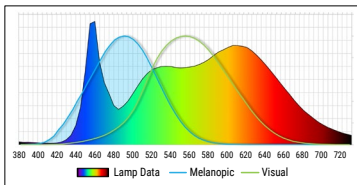

**BioUp 4000K LED**  
MDER = .82

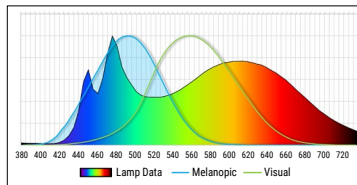

## 30% boost Biological impact compared to traditional LED sources

CCT	LED MDER ~83 CRI	BioUp Static		BioUp Dynamic	
		MDER	CRI	MDER	CRI
2700K	0.44	-	-	0.43	95
3000K	0.49	-	-	0.54	94
3500K	0.56	0.71	90	0.71	90
4000K	0.64	0.84	87	0.82	87
5000K	0.77	0.98	84	0.98	84

BioUp enhances the LED spectrum with cyan light at 475nm increasing the biological impact of the light to enhance our circadian rhythm which regulates our sleep/wake cycle, daytime engagement, and mood – **all without distorting visual color impression.**

### Static (non-tunable)

Static BioUp is used when simple Melanopic Lighting is desired at all times.

Arrow in graph shows BioUp spectrum boost is at 475nm where non-visual biological response is enhanced.

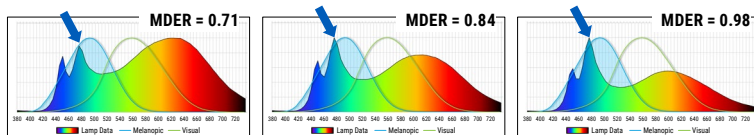

**3500K** or **4000K** or **5000K**

Cyan light component always present



> no CCT control needed

### Dynamic - (Tunable)

Dynamic BioUp is used when Melanopic Lighting is desired to adjust during the day.

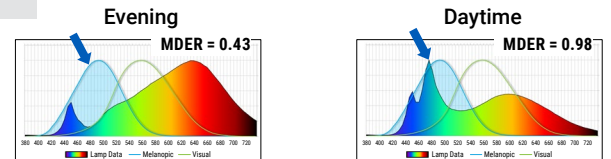

Warmer CCT Without Cyan content ← → Cooler Light With Cyan content

**2700K – 5000K**



> Control with Wavelinx, 2ch 0-10V, or DALI