

<b>Project</b>		<b>Catalog #</b>		<b>Type</b>	
<b>Prepared by</b>		<b>Notes</b>		<b>Date</b>	



# Metalux

## Cruze ST 24CZ2

2' x 4' LED Specification Grade Troffer

### Typical Applications

Office • Education • Healthcare • Hospitality • Retail

### Product Certification



### Product Features



### Interactive Menu

- Order Information page 2
- Photometric Data page 4
- Control Solutions page 6
- VividTune™ Color Tuning Solutions page 7
- BioUp - Melanopic Lighting page 8
- Product Warranty

### Top Product Features

- Latch-less design provides clean architectural look
- BioUp melanopic lighting options for 30% circadian boost and earn WELL Building Standard points
- VividTune CCT tuning options from 3000K-5000K or 2700K-6500K
- Designers delight - ribbed, smooth and round perforated lens options
- High performance efficacy up to 167 lm/W
- Integrated sensor systems - occupancy, daylight and IoT connectivity
- Options to meet Build America, Buy America, Buy American and other domestic preference requirements

### Dimensional and Mounting Details

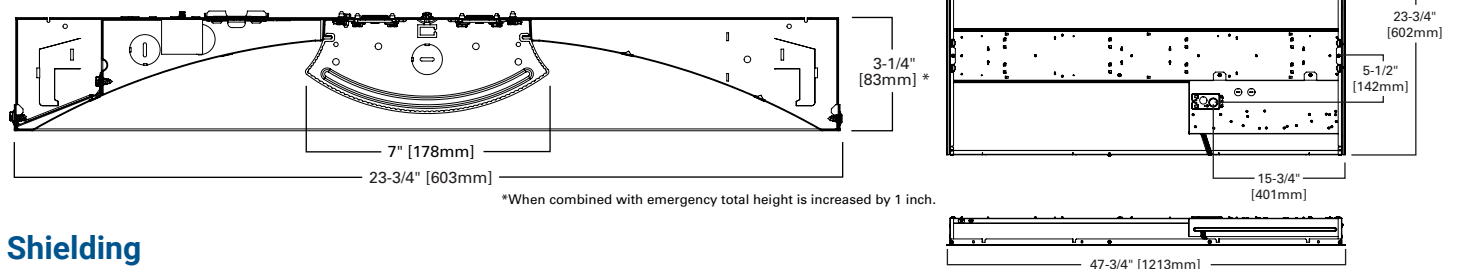

### Shielding

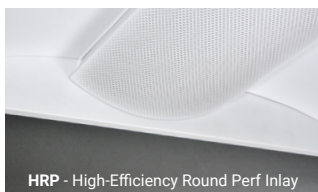

See ordering information for more shielding options.



### Ceiling Compatibility

Grid/Lay-in Standard	Concealed T	Slot Grid	Ceiling Type	Trim Type
			Exposed Grid	Standard
			Concealed T	Standard
			Slot Grid	Standard
			Flange	*

\*See Drywall Frame Kit Accessory in Ordering Information Section

## Order Information

SAMPLE ORDER NUMBER: **24CZ2-45HE-UNV-L835-CD1-U**

Domestic Preferences <sup>(1)</sup>	Rating	Series	Air	Lumen Level / Efficacy Option		
<b>[Blank]</b> =Standard <b>BAA</b> =Buy American Act <b>TAA</b> =Trade Agreements Act <b>BABA</b> =Build America Buy America Act	<b>[Blank]</b> =Standard <b>ATW-SW4</b> =Chicago Rated	<b>24CZ2</b> =2x4 Cruze ST	<b>[Blank]</b> =Standard <b>A</b> =Air (Vented) <sup>(2)</sup>	<b>Standard [Blank]</b> 30=3000 Lumens 35=3500 Lumens 40=4000 Lumens 45=4500 Lumens 50=5000 Lumens 55=5500 Lumens 60=6000 Lumens <sup>(3)</sup> 65=6500 Lumens <sup>(3),(4)</sup>	<b>High Efficacy [HE]</b> 30HE=3000 Lumens 35HE=3500 Lumens 40HE=4000 Lumens 45HE=4500 Lumens 50HE=5000 Lumens 55HE=5500 Lumens 60HE=6000 Lumens <sup>(4),(6)</sup> 65HE=6500 Lumens <sup>(4),(6)</sup> 70HE=7000 Lumens <sup>(4),(6)</sup> 75HE=7500 Lumens <sup>(3),(4)</sup>	<b>Very High Efficacy [VHE]</b> 30VHE=3000 Lumens <sup>(3)</sup> 35VHE=3500 Lumens <sup>(3)</sup> 40VHE=4000 Lumens <sup>(3)</sup> 45VHE=4500 Lumens <sup>(3)</sup> 50VHE=5000 Lumens <sup>(3)</sup> 55VHE=5500 Lumens <sup>(3)</sup> 60VHE=6000 Lumens <sup>(3)</sup> 65VHE=6500 Lumens <sup>(3),(4)</sup> 70VHE=7000 Lumens <sup>(3),(4)</sup> 75VHE=7500 Lumens <sup>(3),(4)</sup> 80VHE=8000 Lumens <sup>(3),(4)</sup> 85VHE=8500 Lumens <sup>(3),(4)</sup> 90VHE=9000 Lumens <sup>(3),(4)</sup> 95VHE=9500 Lumens <sup>(3),(4)</sup> 100VHE=10000 Lumens <sup>(3),(4),(5)</sup> 110VHE=11000 Lumens <sup>(3),(4),(5)</sup> 120VHE=12000 Lumens <sup>(3),(4),(5)</sup> 130VHE=13000 Lumens <sup>(3),(4),(5)</sup> 150VHE=15000 Lumens <sup>(3),(4),(5)</sup> 170VHE=17000 Lumens <sup>(3),(4),(5)</sup>
<b>Notes</b> (1) Only product configurations with these prefixes are built to be compliant with the Buy American Act of 1933 (BAA), Trade Agreements Act of 1979 (TAA), or the Build America Buy America Act (BABA). BABA is the minimum Government compliance requirement for the Build America Buy America standards which is part of the Infrastructure and Investment Jobs Act (IIJA). Individual Government Agencies may have more stringent compliance standards. Please refer to <a href="#">DOMESTIC PREFERENCES</a> website or consult the CLS Domestic Preferences team for more information. Components shipped separately may be separately analyzed under domestic preference requirements.			<b>Notes</b> (2) Air version is intended for air return through plenum. See air return data table for air flow volumes. Air option not available with ATW-SW4. Air requires "PAF" option.	<b>Notes</b> (3) VividTune white tuning and BioUP static and dynamic options are not available with these lumen/efficacy selections. (4) Available with CD or HCD drivers only. (5) Requires 2 CD-1 drivers above 100VHE. (6) W2D Dali dimming BioUp not available with these options.		

Shielding	Voltage <sup>(7)</sup>	Options	Emergency Options
<b>[Blank]</b> =Ribbed Frosted Acrylic Lens (standard) <b>S</b> =Smooth Frosted Acrylic Lens <b>HRP</b> =High-Efficiency Round Perf Inlay <b>SQR</b> =Square Ribbed Frosted Acrylic Lens	<b>UNV</b> =Universal Voltage 120-277 <b>347V</b> =347 Volt <sup>(8)</sup>	<b>GL</b> =Single Element Fuse <b>GM</b> =Double Element Fuse <b>PAF</b> = Painted After Fabrication	<b>[Blank]</b> =No emergency <b>EL7W</b> =7-watt 120V-277V emergency battery pack <sup>(9)</sup> <b>EL10W</b> =10-watt 120V-277V emergency battery pack <sup>(9)</sup> <b>EL14W</b> =14-watt 120V-277V emergency battery pack <sup>(9)</sup> <b>EL10WSD</b> =10W emergency battery pack with self-diagnostic installed <sup>(9),(11)</sup> <b>EL14WSD</b> =14W emergency battery pack with self-diagnostic installed <sup>(9),(11)</sup> <b>ETRD</b> =Emergency Transfer Relay with dimming control <sup>(10)</sup> <b>RRU</b> =LVS Controls Emergency Transfer Relay with dimming control <sup>(10)</sup> <b>UEL7W</b> =UL924 Listed luminaire, 7-watt, 120V-277V emergency battery pack <sup>(13),(9)</sup> <b>UEL14W</b> =UL924 Listed luminaire, 14-watt 120V-277V emergency battery pack <sup>(13),(9)</sup> <b>UEL10WSD</b> =Bodine 10W emergency battery pack with self diagnostic installed <sup>(13),(9),(12)</sup> <b>UETRD</b> =UL924 Listed luminaire, Emergency Transfer Relay with dimming control <sup>(13),(10)</sup> <b>URRU</b> =UL924 Listed luminaire, LVS Controls Emergency Transfer Relay with dimming control <sup>(13),(10)</sup> <b>WNPS</b> =WaveLinX with Normal Power Sensing Beacon <sup>(14),(15),(16),(17)</sup> <b>WEM</b> =WaveLinX Enabled UL924 <sup>(14),(16),(17)</sup>
	<b>Notes</b> (7) Products also available in non-US voltages and frequencies for international markets. (8) Some 347V versions require a transformer. Total wattage will increase by 2 watts if used.		<b>Notes</b> (9) Factory installed with integral test switch/indicator/laser test. For approximate delivered lumens multiply the lumens per watt of the desired fixture by the wattage of the emergency battery pack (100 lm/W x 7=700 lumens). IES-format photometry for luminaire under emergency operation available. Battery option increases total height by 1 inch. (10) Used to bypass local control during outage. Must be used in conjunction with UL 1008 device (provided by others). Devices are universal voltage (UNV). 347 not available. (11) EL10WSD and EL14WSD not available with 347V. (12) UEL10WSD not available with 347V. (13) Cannot be used with BioUP options. (14) Only available as part of a WaveLinX control system; must order with WLS or WPS sensor. Compatible with UNV CD drivers only. (15) WNPS is compatible with ESP-L or ESP-P emergency control devices. (16) Cannot be combined with other emergency, control or relay options. (17) For UL924 compliance, WEM and WNPS luminaires must be installed in the same application space.

continued next page

**Order Information**

CONTINUED

CRI/CCT	Flex
<p><b>L830</b>=80CRI, 3000K  <b>L835</b>=80CRI, 3500K  <b>L840</b>=80CRI, 4000K  <b>L850</b>=80CRI, 5000K  <b>L930</b>=90CRI, 3000K  <b>L935</b>=90CRI, 3500K  <b>L940</b>=90CRI, 4000K  <b>L950</b>=90CRI, 5000K  <b>L83050</b>=80CRI 3000K-5000K White Tuning <sup>(18)</sup>  <b>L93050</b>=90CRI 3000K-5000K White Tuning <sup>(18)</sup>  <b>L82765</b>=80CRI 2700K-6500K White Tuning <sup>(18)</sup>  <b>L92765</b>=90CRI 2700K-6500K White Tuning <sup>(18)</sup>  <b>B35</b>=BioUp Static 3500K <sup>(19)</sup>  <b>B40</b>=BioUp Static 4000K <sup>(19)</sup>  <b>B50</b>=BioUp Static 5000K <sup>(19)</sup>  <b>B2750</b>=BioUp Tunable 2700K-5000K <sup>(20)</sup></p>	<p><b>[Blank]</b>=No Flex  <b>A3/8-4/18GDIM</b>=3/8" Flex with 0-10V Dimming Leads  <b>A3/8-2/18G</b>=3/8" Flex with line and common  <b>A3/8-5/18GDIM</b>=Flex with 0-10V Dimming leads and Blue for alternate wiring. See below for details.</p>
<p><b>Notes</b></p> <p>(18) VividTune provides correlated color temperatures (CCT) between 3000K (warm) to 5000K (cool) or 2700K (warm) to 6500K (cool). Must be used in conjunction with W2A driver only. Must be used with two (2) 10V dimming control channels, 1 cct, 1 intensity. May be combined with Wavelinx sensor control systems. (19) BioUp Static to be used with HCD driver. (20) BioUp Tunable provides correlated color temperatures (CCT) between 2700K (warm) to 5000K (cool). Must be used with W2A (for two channel 0-10V Control) or W2D (for 2 channel Dali Control) driver. See BioUp page for more information.</p>	<p><b>Flexible Metal Conduit Options</b></p> <p>Flex options available for 0-10V dimming control, DALI dimming control, emergency and night light functions. 72-inch factory-installed and pre-wired to driver, fitted to luminaire housing access plate with 90° enclosed FMC connector. Not all options may be combined and installation ratings vary by type. See online configurator for all flex options.  <b>A3/8-4/18GDIM series notes:</b> Factory installed dimming option 3/8" flexible metal conduit with 2-#18 power and ground wires and 2-#18 UL-listed jacketed 0-10V +/- control wires. Meets UL 66, 83, 1479, 1569, 1581, 2356, NEC® 250.118, 300.22(C), 392, 396, 330, 501, 502, 505, 530, 504, 505, 518, 520, 530, 645, 72; Federal Specification A-A-59544 (formerly J-C-30B); all applicable OSHA and HUD Requirements. UL Classified 1-, 2-, and 3-hour through penetration with applicable fire stop product (not included). May be surface mounted, fished and/or embedded in plaster. Cable tray and approved raceway rated, install per NEC®; Environmental Air-Handling Space Installation per NEC® 300.22(C).</p>

Driver Type	Number of Drivers	Integrated Sensing Systems <sup>(27)</sup>	Packaging
<p><b>CD</b>=0-10V Driver (10%-100% Dimming) <sup>(24), (25), (23)</sup>  <b>CDW</b>=NonProgrammable Driver, Limited Lumen Packages, 0-10V Dimming (10%-100%)  <b>HCD</b>=0-10V Driver (1%-100% Dimming) <sup>(24), (25), (23)</sup>  <b>SLTD</b>=DALI Driver (5%-100% Dimming)  <b>SLTHD</b>=DALI Driver (1%-100% Dimming)  <b>SD</b>=Step Dimming Driver (50%-100% Dimming)  <b>LH</b>=Lutron HiLume 1% EcoSystems (LDE1) <sup>(F)</sup>  <b>W2A</b>=White Tuning, 2 ch, Analog 0-10V (1%-100% Dimming) <sup>(21), (23)</sup>  <b>W2D</b>=White Tuning, DALI Type 8 (1%-100% Dimming) <sup>(19)</sup></p>	<p><b>1</b>=1 Driver  <b>2</b>=2 Drivers <sup>(26)</sup></p>	<p><b>[Blank]</b>=No Sensor  <b>WLS</b>=WaveLinX LITE Integrated Sensor, Dim and Daylight, Bluetooth, 8'-15' MH <sup>(28), (B)</sup>  <b>WPS</b>=WaveLinX PRO Integrated Sensor, Dim and Daylight, ZigBee, 8'-15' MH <sup>(28), (A)</sup>  <b>WLN</b>=WaveLinX LITE Integrated Node, Dim and Daylight, Bluetooth <sup>(29), (B)</sup>  <b>WPN</b>=WaveLinX PRO Integrated Node, Dim and Daylight, Zigbee <sup>(28), (A)</sup></p>	<p><b>U</b>=Unit Pack  <b>PAL</b>=Job Pack, out of carton  <b>PALC</b>=Job Pack, in carton</p>
<p><b>Notes</b></p> <p>(21) W2A used with two (2) 10V dimming control channels - cct and intensity. (22) W2D for use with BioUP options only. White tuning CCT between 2700K and 5000K. Must be used with DALI controls; one address to control two channels - intensity and CCT. May not be used with sensing systems. For Emergency options ONLY EL10WSD can be used. (23) When selecting 0-10V driver with Integrated Sensing System a 0-10V driver might be substituted with another type. (24) WPS and WPN node used with CD, HCD or W2A drivers only. (25) WLS and WLN node used with CD or HCD drivers only.  Integrated options must be used in conjunction with the associated system and may not be compatible with other options or accessories. Please refer to the following: (F) Consult Marketplace Options - Lutron system pages for additional details and compatibility. Compatible only with driver series shown, and may require two or more drivers. Requires field commissioning to operate or dim. Contact Lutron at www.lutron.com.</p>	<p><b>Notes</b></p> <p>(26) See lumen limitation notes for applications requiring 2 drivers or use online configurator. When combined with emergency total height is increased by 1 inch.</p>	<p><b>Notes</b></p> <p>(27) Add "D" to sensor ordering logic - WPSD or WLS D, to create a symmetrical dual band appearance on the luminaire/lens. (28) WPS and WPN node used with CD, HCD or W2A drivers only. (29) WLS and WLN node used with CD or HCD drivers only.  Integrated options must be used in conjunction with the associated system and may not be compatible with other options or accessories. Please refer to the following: (A) Consult WaveLinX PRO system pages for additional details and compatibility. (B) Consult WaveLinX LITE system pages for additional details and compatibility.</p>	

Accessories (order separately) <sup>(31)</sup>
<p><b>CZ2-EQCLIP-U PK</b>=CZ2" Earthquake Clip Kit (4 clips per bag kit) <sup>(30)</sup>  <b>DF-24W-U</b>=2' x 4' Drywall Frame Kit  <b>SMK-24-W</b>= 4" Tall Surface Mount Kit, 2' x 4'</p>
<p><b>Notes</b></p> <p>(30) An EQ Grid Clip is recommended for all 9/16" ceiling systems. Four required per fixture. (31) Accessories sold separately will be separately analyzed under domestic preference requirements. Consult factory for further information.</p>

## Product Specifications

### Construction

- Die formed of code gauge prime cold rolled steel with full length die-formed stiffeners
- Unibody endplates attached with interlocking tabs and screws
- Hemmed side flanges
- Four auxiliary fixture end suspension points
- Integral Grid-lock feature for endplates for added safety
- Optional earthquake clips available

### Integrated Controls

- Standard with 0-10V dimming driver (10% standard, 1% optional)
- Integrated WaveLinX options provide wireless individual fixture control and enable code compliance, increased energy savings, grouping of fixtures, and connection to WaveLinX control systems
- DALI 2.0, Lutron, and step-dimming available

### LED and Light Engine

- LED's available in 3000K, 3500K, 4000K, or 5000K at 80 CRI minimum and 90 CRI minimum
- Color accuracy  $\leq$  3-Step MacAdam ellipse (SDCM)
- TM21 life at 60,000 hours up to L90 and calculated L70 exceeds 203,000 hrs.
- Drivers available in 120-277V and 347V
- Tunable white options available with Cooper Lighting Solutions' VividTune
- BioUp melanopic lighting options available in static or tunable white

### Emergency Options

- 120V-277V integral emergency battery pack comes in 7-watts, 10-watt, or 14-watts
- Self-diagnostic emergency battery available in 10 or watts (NFPA 101@ Life Safety Code®)
- Constant power to the LED system for controlled, predictable discharge
- Integrated test switch/indicator light visible from floor
- Min. 90-minute backup period for code compliance
- Integral emergency transfer relay available for generator equipped power systems

### WNPS - WaveLinX Normal Power Sensing

- Normal Power Sensing (NPS) wireless beacon enabled luminaire that signals normal power is present
- Must be ordered with WaveLinX LITE or PRO sensor as part of a WaveLinX control system
- For UL924 compliance, WNPS enabled luminaires with standard product and compatible emergency control devices (ESP-P/ESP-L) must be installed in same application space

### WEM - WaveLinX UL924 Emergency Sensor

- Emergency control devices (ESP-P/ESP-L) not required when WEM and WNPS luminaires are installed in the same application space
- For UL924 compliance, order WEM and WNPS luminaires in the same application space
- WEM must be ordered with WLS or WPS sensor as part of a WaveLinX control system

### Shielding

- Ribbed acrylic frosted lens standard
- Optional smooth acrylic frosted lens (S)
- Optional square ribbed frosted acrylic lens (SQR)
- Optional High-Efficiency Round Perf Inlay (HRP)
- Replacement lenses available, contact factory
- Lens is acrylic with features on the face and sides to optimize the direct and indirect lighting contributions for improved glare and efficacy

### Compliance

- IC rated for insulation contact
- cULus listed for damp locations
- UL924 luminaire listing available, see Emergency Options
- RoHS compliant
- Tested to IESNA LM-79 and LM-80
- Stated life tested to TM21 standards
- Can be used for State of California Title 24 high efficacy luminaire

### BABA Domestic Preference Compliance

- This Cooper product is manufactured in the US and meets the BABA cost of components rule. To verify a configured product with specific accessories and options meets BABA Domestic Preference Requirements; submit this catalog number to Cooper Lighting Quotation team for validation by our Engineering and Manufacturing teams. Our BABA designation is based on the minimum compliance requirement for BABA. Individual Government Agencies may have more stringent compliance standards. Please refer to the [DOMESTIC PREFERENCES](#) website or consult the CLS Domestic Preferences team for more information. Components shipped separately may be separately analyzed under domestic preference requirements.

### Warranty

- Five-year limited warranty standard. Optional ten year limited warranty available.

### Finish

- Multistage, iron phosphate pretreatment
- 90% reflective, matte white enamel finish
- Full fixture housing pre-painted matte white (choose PAF option for "Paint after Fabrication")

## Photometric Data

 [View IES files](#)

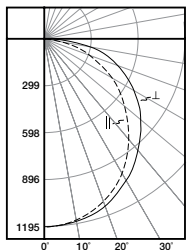

### 24CZ2-35-UNV-L830-CD1-U

Dimming Driver  
 Linear LED 3000K  
 Spacing criterion: (II) 1.22 x mounting height,  
 (L) 1.28 x mounting height  
 Lumens: 3618  
 Input Watts: 30.1W  
 Efficacy: 120.2 LPW  
 Test Report: 24CZ2-35-UNV-L830-CD1-U.IES

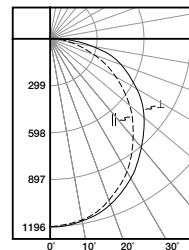

### 24CZ2-35HE-UNV-L830-CD1-U

Dimming Driver  
 Linear LED 3000K  
 Spacing criterion: (II) 1.21 x mounting height,  
 (L) 1.27 x mounting height  
 Lumens: 3562  
 Input Watts: 26.9W  
 Efficacy: 132.4 LPW  
 Test Report: 24CZ2-35HE-UNV-L830-CD1-U.IES

## Energy and Performance Data

Standard Efficacy Versions – Single Row of LEDs  
Default CCT/Lumen Setting: 3500K/Med

Catalog Number	Lumens	Watts	lm/W
24CZ2-30-UNV-L835-CD1-U	3028	22.4	135
24CZ2-35-UNV-L835-CD1-U	3633	27.3	133
24CZ2-40-UNV-L835-CD1-U	4178	30.4	137
24CZ2-45-UNV-L835-CD1-U	4602	35.0	132
24CZ2-50-UNV-L835-CD1-U	5049	39.6	128
24CZ2-55-UNV-L835-CD1-U	5571	41.1	135
24CZ2-60-UNV-L835-CD1-U	6056	46.3	131
24CZ2-65-UNV-L835-CD1-U	6601	50.1	132

High Efficacy Versions – Two Rows of LEDs  
Default CCT/Lumen Setting: 3500K/Med

Catalog Number	Lumens	Watts	lm/W
24CZ2-30HE-UNV-L835-CD1-U	3100	22.3	139
24CZ2-35HE-UNV-L835-CD1-U	3685	27.0	137
24CZ2-40HE-UNV-L835-CD1-U	4144	30.7	135
24CZ2-45HE-UNV-L835-CD1-U	4712	35.3	134
24CZ2-50HE-UNV-L835-CD1-U	5164	38.6	134
24CZ2-55HE-UNV-L835-CD1-U	5722	43.5	132
24CZ2-60HE-UNV-L835-CD1-U	6182	44.1	140
24CZ2-65HE-UNV-L835-CD1-U	6777	48.9	139
24CZ2-70HE-UNV-L835-CD1-U	7218	49.3	146
24CZ2-75HE-UNV-L835-CD1-U	7787	55.4	141

Very High Efficacy Versions – Three Rows of LEDs  
Default CCT/Lumen Setting: 3500K/Med

Catalog Number	Lumens	Watts	lm/W
24CZ2-30VHE-UNV-L835-CD1-U	3011	20.4	148
24CZ2-35VHE-UNV-L835-CD1-U	3526	22.8	155
24CZ2-40VHE-UNV-L835-CD1-U	4042	26.2	154
24CZ2-45VHE-UNV-L835-CD1-U	4559	29.6	154
24CZ2-50VHE-UNV-L835-CD1-U	5064	32.7	155
24CZ2-55VHE-UNV-L835-CD1-U	5570	36.1	154
24CZ2-60VHE-UNV-L835-CD1-U	6055	38.7	157
24CZ2-65VHE-UNV-L835-CD1-U	6565	42.2	156
24CZ2-70VHE-UNV-L835-CD1-U	7059	45.7	155
24CZ2-75VHE-UNV-L835-CD1-U	7662	49.9	154
24CZ2-80VHE-UNV-L835-CD1-U	8128	53.8	151
24CZ2-85VHE-UNV-L835-CD1-U	8600	57.9	149
24CZ2-90VHE-UNV-L835-CD1-U	9053	61.8	147
24CZ2-95VHE-UNV-L835-CD1-U	9521	65.6	145
24CZ2-100VHE-UNV-L835-CD1-U	10191	69.6	146
24CZ2-110VHE-UNV-L835-CD2-U	11098	77.4	143
24CZ2-120VHE-UNV-L835-CD2-U	12211	83.6	146
24CZ2-130VHE-UNV-L835-CD2-U	13271	90.7	146
24CZ2-150VHE-UNV-L835-CD2-U	15006	104.2	144
24CZ2-170VHE-UNV-L835-CD2-U	17021	123.4	138

### Shielding

Lumen Adjustment Factors		
S	HRP	SQR
1.05	0.81	0.96

### Lumen Calculator

CCT Multiplier	80 CRI	90 CRI <sup>(1)</sup>	BioUp Static
3000K	0.965	0.827	-
3500K	1.000	0.847	0.912
4000K	1.019	0.856	0.899
5000K	1.019	0.909	0.879

Notes: (1) Input wattages for 90 CRI versions may vary. Refer to published IES-format photometry or LM-79 reports for more details.

### Example of Lumen Adjustment Calculation

24CZ2-40-UNV-L835-CD1-U at 90CRI at 3500K

Lumen Adjustment Factor = 0.845

Total Light Output =

4,196 lm x 0.845 = 3,546 lm

Efficacy = 3,546 lm = 98 lm/W  
36.2W

### Lumen Maintenance

Version	TM-21 Lumen Maintenance (60,000 hours) <sup>(2)</sup>	Theoretical L70 (Hours) <sup>(3)</sup>
Standard	> 87%	> 151,000
High Efficiency	> 90%	> 203,000
Very High Efficiency	> 90%	> 203,000

Notes: (2) Supported by IES TM-21 standards. (3) Theoretical values represent estimations commonly used; however, refer to the IES position on LED Product Lifetime Prediction, IES PS-10-18, that explains proper use of IES TM-21 and LM-80.

### Load Data (Stock Product)

Thd	6%
Power Factor	0.99
Weight (lbs.)	16
Low Temp. Start	-20°C

### Shipping Data

Catalog No.	Wt.	Pallet 49" L x 52" W x 46" H
2' x 4'	20.4 lbs.	28

### Air Return Volume

Negative Static Pressure (Inches H <sub>2</sub> O)	Return Air Volume (CFM)
0.05	75
0.1	103
0.2	153
0.25	177
0.3	191
0.45	234

## Control Solutions

- WaveLinX LITE wireless
- WaveLinX PRO wireless
- WaveLinX CAT wired
- WaveLinX DALI wired



The Cruze ST with WaveLinX offers no-hassle lighting control with multiple luminaire level control solutions.

**WaveLinX** by Cooper Lighting Solutions is a wired and wireless solution for a single room, a parking lot, or an entire campus, helping meet energy codes, reduce energy use, and create healthier environments. As a true hybrid architecture, it enables the seamless integration of DALI, CAT, and PRO technologies and luminaires for unmatched reliability and flexibility, with sensor-enabled luminaires that can also share data with the WaveLinX CORE platform, further improving operations across office, education, healthcare, warehouse, and parking garage applications.

### Integrated Sensor Coverage Pattern

TOP VIEW:

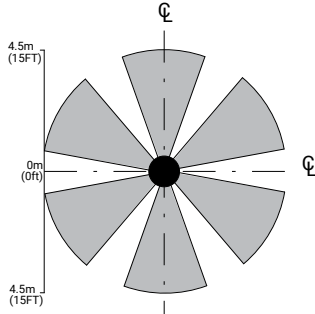

SIDE VIEW:

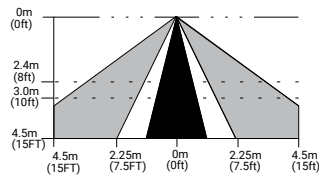

**Note:** Installation of integrated sensors within 3-ft (1m) of HVAC air vents is not recommended. The pattern shown is intended solely as a general guide and is not to scale.



**WaveLinX LITE** is a Bluetooth wireless digital lighting control solution with out-of-the-box functionality that saves energy and meets energy codes. It's designed for applications that require occupancy-based, daylighting, or manual light control using WaveLinX LITE-enabled luminaires and a mobile app for cost-effective projects.



**WaveLinX PRO** is a Zigbee wireless solution that offers a rich portfolio of devices, WaveLinX PRO-enabled luminaires, and a mobile app and the WAC (WaveLinX Area Controller). It offers advanced energy savings and deep data integration to improve the occupant experience.



**WaveLinX CAT** is a scalable CAT5-wired solution for a single room and connected spaces, supporting applications that require occupancy-based, daylighting, or manual light control, with self-commissioning to meet energy codes and maximize energy savings.



**WaveLinX DALI** is a powerful two-wire DALI-2 solution for connected spaces, combining open-standard devices enabling interoperability with the simplicity of WaveLinX app-based commissioning. It delivers deterministic wired control, granular addressability, and tunable white.

### Integrated Controls Options

Option	Out of the Box Functionality	Luminaire Level Lighting Control (LLLC)	Automatic Dimming Photocell	Occupancy Sensing	CCT Control*
WLS (WaveLinX LITE Sensor)	X	X	X	X	
WLN (WaveLinX LITE Node)		X			
WPS (WaveLinX PRO Sensor)		X	X	X	X
WPN (WaveLinX PRO Node)		X			X

**Note:** \*WaveLinX utilizes scenes to allow users to change an area's fixtures Correlated Color Temperature (CCT) and intensity using a commissioned wireless wallstation scene controller. To enable CCT adjustments through WaveLinX, include WPS or WPN devices in addition to VividTune or BioUp technologies for integrated fixture control. WPS with CCT controls the intensity of the fixture; an additional, externally mounted control device is needed to control the CCT. See [RSP-P-010-347](#)

The WNPS and WEM (UL924 option) only available with WLS or WPS sensors. Must be specified when ordered. WEM must be associated with a group that includes a normal power sensing device to receive NPS beacon. Learn more about WaveLinX EM [here](#).

#### With Integrated WaveLinX Sensor

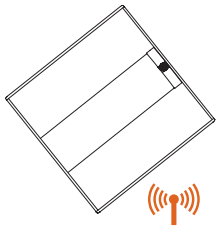

#### With Integrated WaveLinX Node

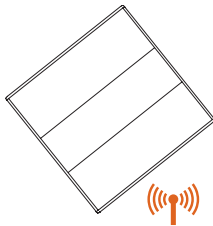

Add a hidden WaveLinX Node (WPN, WLN) to your space lighting design!

To:

- Keep luminaire aesthetics
- Connect fixtures without space for a sensor, such as downlights
- Connect sealed fixtures without a standard sensor option such as products for clinical space

### WaveLinX EM

The WaveLinX Emergency (WEM) solution offered by WaveLinX wireless (PRO and LITE) makes it easy to design your UL924 certified emergency lighting solution. Fixture-integrated WaveLinX Emergency Modules (WEM) override lighting controls and increases light output to emergency level (100%) until normal power is restored. Needs programming. WaveLinX emergency systems are designed to meet UL 924 standards. Learn more [here](#).

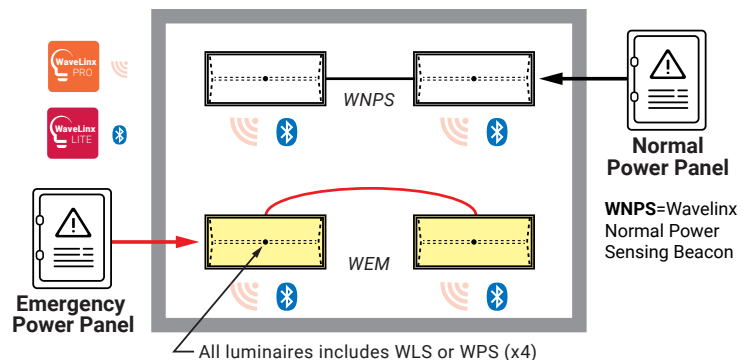
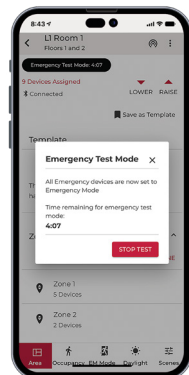



**24 Cruze ST LED with VividTune Tunable White**

VividTune tunable white luminaires from Cooper Lighting Solutions deliver high-quality light in a broad range of continuously variable color temperatures and intensities. Create a dynamic environment by adjusting the ambient light warmer or cooler to influence mood, support the task at hand, or create a dramatic ambience. The ability to control correlated color temperature and intensity separately using simple controls is the next evolution of LED lighting for the commercial, educational, healthcare and hospitality space. The unparalleled flexibility and number of available lighting environments enable users to find the right light with tunable white.

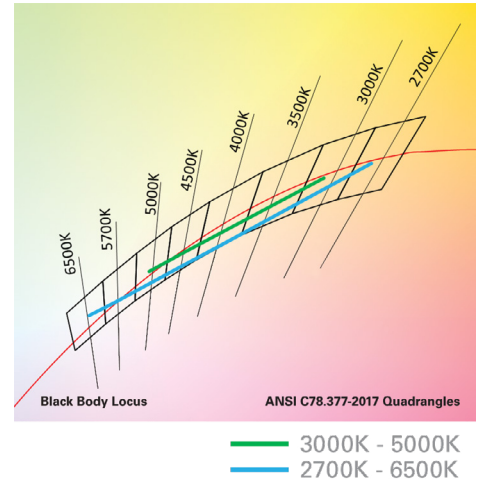

**Energy and Performance Data**

Tunable White - Lumen Adjustment Factors						
CCT	VividTune 3000K-5000K		VividTune 2700K-6500K		BioUp Tunable White 2700K-5000K	
	80 CRI	90 CRI	80 CRI	90 CRI	CRI	Lumen Adjustment
2700K	-	-	0.903	0.771	95	0.938
3000K	0.929	0.765	0.928	0.801	94	0.929
3500K	0.983	0.836	0.961	0.842	90	0.912
4000K	1.033	0.903	0.981	0.868	87	0.899
4500K	1.042	0.918	0.999	0.891	85	0.890
5000K	1.042	0.918	1.013	0.909	84	0.879
6500K	-	-	1.028	0.933	-	-

2' x 4' Cruze ST LED - Example of Approximate Lumen Calculation				
	Standard Catalog #	VividTune 80 CRI Catalog #	VividTune 90 CRI Catalog #	BioUp Tunable White
CCT Setting	24CZ2-40HE-UNV-L835-CD1-U	24CZ2-40HE-UNV-L83050-W2A1-U	24CZ2-40HE-UNV-L93050-W2A1-U	24CZ2-40HE-UNV-B2750-W2A1-U
2700K	-	3638	3106	3779
3000K	-	3641	2998	3743
3500K	4029	3853	3275	3674
4000K	-	4046	3537	3622
4500K	-	4084	3599	3586
5000K	-	4084	3599	3541
6500K	-	4142	3579	-

**Controlling VividTune and BioUp Tunable White**

From wall dimmers to wireless controls, tunable white luminaires are compatible with industry standard 0-10V and DALI controls. One channel to control intensity (brightness) and a second channel to adjust CCT.

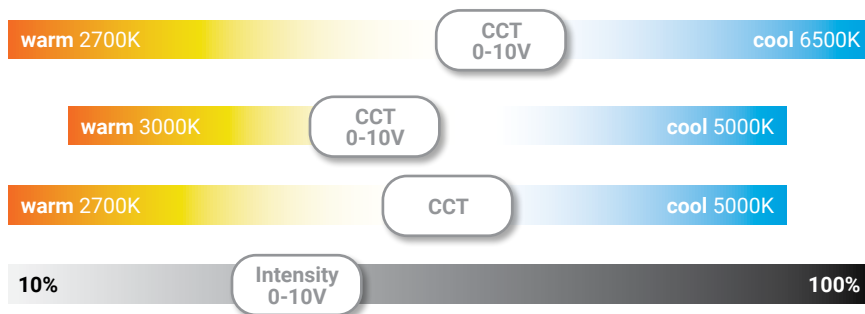

**Example of Lumen Adjustment Calculation**

24CZ2-40HE-UNV-L83050-W2A1-U at 80 CRI tuned to 3500K

Adjusted Lumen = published lm x adjusted lm factor

Adjusted Lumen = 4029 x 0.956

Adjusted Lumen = 3853 lm

*\* Lumen adjustment factors are for reference and may be different for each product selected. Refer to IES files for actual performance data on each.*

# Proven Research. Industry Recognized.

## BioUp Melanopic Lighting



See better



Feel better



Function better



See [BioUp brochure](#) for more details



**ANSI/IES RP-46-23 / TM18 published March 2024 based on over 40 years of research.**

"...circadian clock synchronization is paramount to the body's efficient and appropriate functioning." – TM18



**BioUp solutions maximize WELL points for Circadian Lighting Design (L03):**

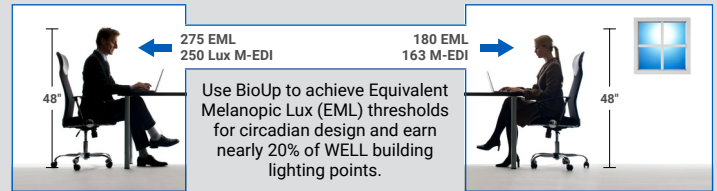

**MDER, M-EDI and EML** are key metrics used to quantify non-visual performance of indoor lighting systems.

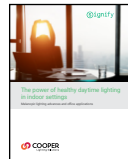

See [BioUp white paper](#) for more details

**MDER** - Melanopic Daylight Efficacy Ratio (MDER) measures the amount of light stimulating to the melanopsin receptors.

**Standard 4000K LED**  
MDER = .62

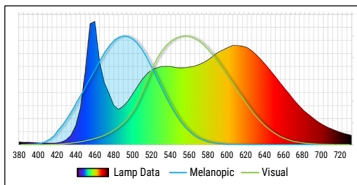

**BioUp 4000K LED**  
MDER = .82

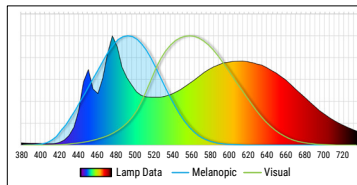

## 30% boost Biological impact compared to traditional LED sources

CCT	LED MDER ~83 CRI	BioUp Static		BioUp Dynamic	
		MDER	CRI	MDER	CRI
<b>2700K</b>	0.44	–	–	0.43	95
<b>3000K</b>	0.49	–	–	0.54	94
<b>3500K</b>	0.56	0.71	90	0.71	90
<b>4000K</b>	0.64	0.84	87	0.82	87
<b>5000K</b>	0.77	0.98	84	0.98	84

BioUp enhances the LED spectrum with cyan light at 475nm increasing the biological impact of the light to enhance our circadian rhythm which regulates our sleep/wake cycle, daytime engagement, and mood – **all without distorting visual color impression.**

### Static (non-tunable)

Static BioUp is used when simple Melanopic Lighting is desired at all times.

Arrow in graph shows BioUp spectrum boost is at 475nm where non-visual biological response is enhanced.

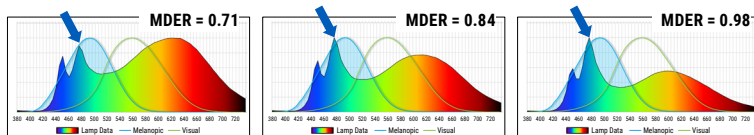

**3500K** or **4000K** or **5000K**

Cyan light component always present



> no CCT control needed

### Dynamic - (Tunable)

Dynamic BioUp is used when Melanopic Lighting is desired to adjust during the day.

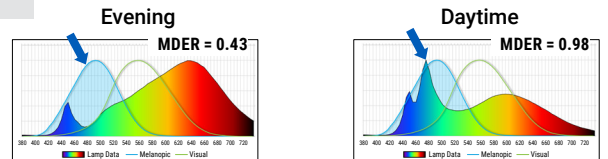

Warmer CCT Without Cyan content ← → Cooler Light With Cyan content

**2700K – 5000K**



> Control with Wavelinx, 2ch 0-10V, or DALI