

Project		Catalog #		Type	
Prepared by		Notes		Date	



PORTFOLIO

LDSQA4A 4L

4-Inch Square Adjustable Slope Wall Wash
New Construction
1000-3500 Lumens

Typical Applications

Healthcare • Hospitality • Retail • Institutional • Indoor Display & Signage

Interactive Menu

- Order Information [page 2](#)
- Product Specifications [page 3](#)
- Energy & Performance Data [page 3](#)
- Photometric Data [page 4](#)
- Connected Systems [page 6](#)
- Product Warranty



Top Product Features

- Square adjustable accent/slope for flat or sloped ceilings
- Excellent light control and low aperture brightness
- Lockable 365° rotation and 45° tilt holds any aiming position
- Anodized aluminum reflectors, Holds 2 lens media
- 2400K, 2700K, 3000K, 3500K, 4000K and 5000K CCT
- CRI: 90, 97 and D2W option from 3000K to 1850K
- Angle cut or lensed angle cut reflectors
- Lumens: 1000-3500, Field-interchangeable optics: 15°, 25° or 35°

Dimensional and Mounting Details

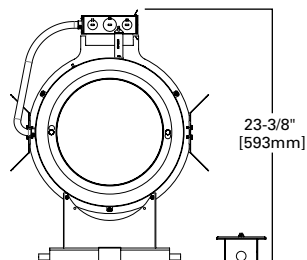
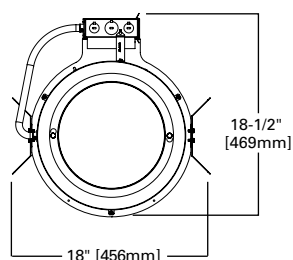

with battery

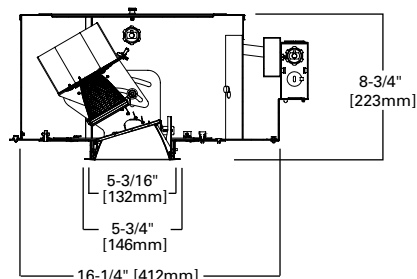

Order Information

SAMPLE ORDER NUMBER: **LDSQA4A09835D010TE**

Housing	Lumens ⁽¹⁾	CRI	CCT	Voltage	Driver ⁽⁷⁾	Options ⁽⁹⁾
LDSQA4A =4" Square Aperture adjustable/ slope LDSQA4ACP =4" Square Aperture adjustable/ slope, Chicago Plenum	10 =1000 (IC Rated) 15 =1500 (IC Rated) 20 =2000 (IC Rated) 25 =2500 (Non-IC) 30 =3000 (Non-IC) 35 =3500 (Non-IC)	90 =90 CRI 97 =97 CRI (2700K and 3000K only)	24 =2400K 27 =2700K 30 =3000K 35 =3500K 40 =4000K 50 =5000K 30D2W = Dim to warm - 3000K to 1850K (2000 lumen and below, 90 CRI) ⁽⁸⁾	[Blank] =120-277V For 2000 lumens and below 1 =120V 2500 lumens and above 2 =277V 2500 lumens and above 3 =347V (D010 driver 1000-2000)	D010 = 0-10V, 1% dimming D010TR =0-10V (120-277V) or phase cut (120V) dimming, 1% to 100% DSL =Fifth Light® DALI DT6 Logarithmic Dimming, 0.1% to 100% DE010 =0-10V Linear Dimming, 0.1% to 100% DMX =DMX/RDM Logarithmic Dimming, 0.1% to 100% ⁽⁶⁾ DMXC5 =DMX/RDM Logarithmic Dimming, 0.1% to 100%, with RJ45 connection ⁽⁶⁾ DLE =Lutron Ecosystem dimming 1-100%	EMBOD =7W Bodine® Emergency Module with Remote Test Switch EMBOD6ST =6W Bodine® Self Test Emergency Module with Remote Test Switch EMBOD7ST =7W Bodine® Emergency Module with Self Test Remote Test Switch EM7 =7W Emergency Module with Remote Test Switch EM14 =14W Emergency Module with Remote Test Switch WPN = WaveLinX PRO Wireless Node without sensor ⁽¹¹⁾ WLN = WaveLinX LITE Wireless Node without sensor ⁽¹²⁾ WPST =Factory installed Wavelinx PRO (includes control module, sensor, cable, tile mount and ceiling mount sensor) ^{(8) (9)} WLST =Factory installed WaveLinX LITE Sensor Kit ^{(8) (10)}

SAMPLE ORDER NUMBER: **LAR25NF**

Beam Forming Reflector
LAR15SP =15° optic LAR25NF =25° optic LAR35FL =35° optic

SAMPLE ORDER NUMBER: **4LSQA1**

Reflector	Finish		Options
4LSQA0 =4" Adjustable Accent, Polymer Trim Ring 4LSQA1 =4" Adjustable Accent, Self Flanged 4LSQAL0 =4" Lensed Adjustable Accent, Polymer Trim Ring 4LSQAL1 =4" Lensed Adjustable Accent, Self Flanged	H =Semi-Specular Clear WMH =Warm Haze WH =Wheat WHH =Wheat Haze	GP =Graphite GPH =Graphite Haze B =Specular Black MB =Matte Black MW =Matte White	Self-Flanged Only WF =White Painted Flange

Accessories				
4SQPR =Plaster Lathing Ring ⁽²⁾ Bar Hangers HB26 =C-channel Bar Hanger, 26" Long, Pair HB50 =C-channel Bar Hanger, 50" Long, Pair RMB22 =Wood Joist Bar Hanger, 22" Long, Pair	Transformers H347 =347 to 120V Step Down Transformer, 75VA Connected Lighting Systems ^{(3) (8)} WPST = Field installed WaveLinX PRO Sensor Kit ⁽⁹⁾ WLST = Field installed WaveLinX LITE Sensor Kit ⁽¹⁰⁾	Color Filters F22-20 =Red F33-20 =Blue F44-20 =Green F55-20 =Yellow F66-20 =Mercury	Dichronic Filters F71-20 =Peach F72-20 =Amber F73-20 =Green F74-20 =Medium Blue F75-20 =Yellow F76-20 =Red F77-20 =Dark Blue F78-20 =Light Blue F79-20 =Neutral Density F80-20 =Magenta	Beam-Modifying Lenses LSL-20 =Linear Spread Lens OSL-20 =Overall Spread Lens DIF-20 =Diffused Lens Louvers LVR-20 =Hex Cell Louver

Notes:

- Nominal Lumens will vary depending on selected color, driver and reflector finish.
- Order trim with polymer trim ring (Consult specification sheet for color ordering information and options).
- Not available with Chicago Plenum and requires above ceiling access. Not for use with insulation.
- Not CSA approved.
- Includes 30° distribution diffuse lens. Order with LAR15SP upper reflector. Reference ies files for output.
- DMX fixtures default to full on upon loss of DMX signal.
- Consult dimming guide for performance.
- Refer to system specifications for additional information, features, and benefits. Order either factory installed option or accessory. Use with 0-10V driver.
- WPST = WaveLinX wireless sensor kit for daylight dimming, PIR motion sensing, and optional RLTS - Real Time Location Services, use with 0-10V only.

- WLST = WaveLinX LITE tile mount sensor kit for daylight dimming, PIR motion sensing, use with D010 only (Refer to WaveLinX LITE system specifications)
- WPN = WaveLinX PRO wireless node PRO provides luminaire-level control with scene and zone configuration without an integrated sensor; Connects wirelessly with daylight dimming sensor and PIR motion sensor if desired. Use with 0-10V driver only.
- WLN = WaveLinX LITE wireless node provides luminaire-level control with scene and zone configuration without an integrated sensor; Connects wirelessly with daylight dimming sensor and PIR motion sensor if desired. Use with 0-10V driver only.

Product Specifications

Lower Reflector

- Aluminum lower reflector is available in a variety of Alzak® and painted finishes.
- Mousetrap springs pull trim tight to ceiling.
- Offered with self flange or polymer trim ring.

Upper Reflector

- Field interchangeable optics in 15°, 25° or 35° provides smooth beam without color separation.
- Media holder fits onto upper reflector and holds up to two lens media.

Trim Ring

- Self flanged or white polymer trim ring.

Adjustment Mechanism

- Stable aiming and locking mechanism allows smooth 365° rotation and 40° tilt adjustment.
- Tilt aiming scale enables consistent setting across multiple fixtures.

Housing

- 20 gauge galvanized steel plaster frame that rotates +/-7.5°.
- 18 gauge CRS housing is painted matte black to eliminate stray light.
- Housing is tool-less top accessible.

Universal Mounting Bracket

- Accepts 1/2" EMT, C Channel, T bar fasteners and hanger bars.
- Provides 5" total adjustment.

Junction box

- Four 1/2" and two 3/4" trade size pry outs positioned to allow straight conduit runs
- Lever connectors for simple push in wiring
- Listed for (4) #12 AWG (two in, two out) 90°C conductors and feed thru branch wiring for 120/277V only.

Thermal

- Aluminum heat sink conducts heat away from the LED module for optimal performance and longer life.

LED

- LED system contains a plurality of high brightness white LED's combined with a high reflectance upper reflector producing even distribution with no pixilation.
- 90 and 97 CRI
- 90 & 97CRI: L78 55,000 hours for 1000-2000 lumens, L90 55,000 for all other lumen output
- Color variation within 2-step MacAdam ellipses
- Available in 2400K, 2700K, 3000K, 3500K, 4000K and 5000K correlated color temperature (CCT)
- Auto resetting, thermally protected, LED's are turned off when safe operating temperatures are exceeded.
- D2W™ – dim-to-warm shifts CCT from 3000K to 1850K as fixture dims mimicking halogen sources.

Driver

- Standard 120-277V 0-10V dimming driver provides flicker-free dimming from 100% to 1%
- Optional combination 120V phase cut/0.1% 0-10V, Fifth Light, DMX or Lutron®
- Driver can be serviced from above or through the aperture.

Connected Lighting System

Two WaveLinX connected solutions to choose from. Refer to WaveLinX system specifications and application guides for details.

WaveLinX PRO Tilemount Sensor Kit

- WaveLinX PRO WPST tilemount sensor kit offers daylight dimming, PIR motion sensing, scene and zone configuration, automatic commissioning; and optional RLTS - RealTime Location Services available.

WaveLinX PRO Wireless Node

- WaveLinX PRO WPN wireless node provides luminaire-level control with scene and zone configuration without an integrated sensor; Connects wirelessly with daylight dimming sensor and PIR motion sensor if desired. Use with 0-10V driver only. **Note:** Not compatible with 347V or Chicago plenum.

WaveLinX LITE Tilemount Sensor Kit

- WaveLinX LITE WLST tilemount sensor kit offers daylight dimming and PIR motion sensing, scene and grouping configuration.

WaveLinX LITE Wireless Node

- WaveLinX LITE WLN wireless node provides luminaire level control with scene and zone configuration without an integrated sensor; Connects wirelessly with daylight dimming sensor and PIR motion sensor if desired. Use with 0-10V driver only. **Note:** Not compatible with 347V or Chicago plenum.

WaveLinX Tilemount Sensor Kits Application

- The WPST and WLST tilemount sensor kits include a control module mounted on the luminaire junction box via 1/2" knock-out, and a tilemount sensor on 54-inch whip; for ceiling installation by direct-mount spring clips or via mounting bracket in octagon ceiling boxes.
- The WPST and WLST tilemount sensor kits may be ordered as factory installed on the luminaire, or ordered separately as a field installed accessory kit.
- **Note: WaveLinX PRO devices are only compatible with the WaveLinX PRO system.**
- **Note: WaveLinX LITE devices are only compatible with the WaveLinX LITE system.**

Code Compliance

- Thermally PROtected
- cULus Certified to UL 1598 / C22.2 No. 250.0 suitable for wet location with lensed trim; damp location with wall wash with covered ceiling
- cULus listed for 25°C ambient environments
- Optional City of Chicago environmental air (CCEA) marking for plenum applications.
- EMI/RFI emissions per FCC 47CFR Part 18 Class B consumer limits.
- IC rated up to 1800 lumens, 2800 lumen is Non-IC rated. RoHS Compliant.
- Photometric testing completed in accordance with IES LM 79 standards.
- Lumen maintenance projections in accordance with IES LM-80-08 and TM-21-11.

Warranty

- Five year warranty www.cooperlighting.com/legal

Energy and Performance Data

Series	1000 Lumen		1500 Lumen		2000 Lumen		2500 Lumen		3000 Lumen		3500 Lumen	
	120V	277V	120V	277V	120V	277V	120V	277V	120V	277V	120V	277V
Input Power	12.3W	12.8W	20.9W	21W	25.3W	25.1W	33W	32.6W	32W	32.6W	39.8W	39.8W
Input Current	0.15A	0.08A	0.23A	0.14A	0.28A	0.15A	0.28A	0.12A	0.28A	0.12A	0.33A	0.15A
Inrush Current	5.29A	11.85A	5.31A	11.97A	5.34A	12.17A	2.5A	11.8A	3.6A	11.8A	3.1A	14.3A
Sound Rating	Class A standards											
Power Factor	< 20%											
THD	>0.90											

Minimum starting temperature -30°C (-22°F)*
 (Nominal input 120-277VAC & 100% of rated output power)

Sound Rating: Class A standards

Notes:
 Emergency Battery packs are rated for a minimum starting temperature of 0°C.

COLOR METRICS - TM-30-15 & CRI/CIE

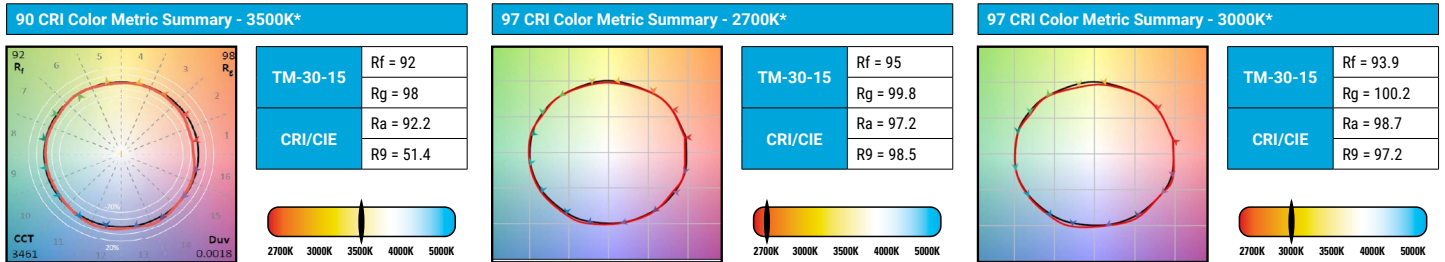

* Color values are based on haze reflector, other finishes and field results may vary.

Photometric Data

15° with LAR15SP optic and 4LSQA1H reflector	
Test Number	P1212205
Housing	LDSQA4A20935D010TE
Module	LAR15SP
Trim	4LSQA1H
Lumens	1775 Lm
Efficacy	61.6 Lm/W
SC	0.32

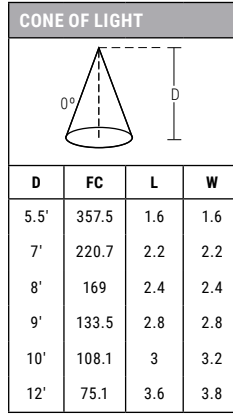
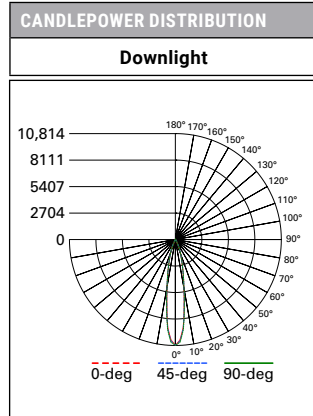

Degrees Vertical	Candela
0	10814
5	9030
15	2634
25	382
35	19
45	4
55	2
65	1
75	0
85	0
90	0

Zone	Lumens	% Fixture
0-30	1751	98.6
0-40	1769	99.7
0-60	1774	99.9
0-90	1775	100
90-180	0	0
0-180	1775	100

25° with LAR25NF optic and 4LSQA1H reflector	
Test Number	P1212209
Housing	LDSQA4A20935D010TE
Module	LAR25NF
Trim	4LSQA1H
Lumens	1970 Lm
Efficacy	68.4 Lm/W
SC	0.47

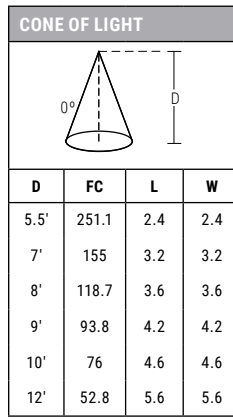
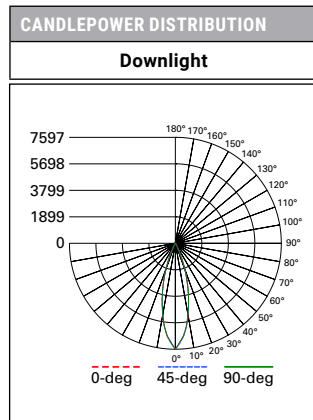

Degrees Vertical	Candela
0	7597
5	6690
15	3549
25	509
35	34
45	6
55	2
65	1
75	0
85	0
90	0

Zone	Lumens	% Fixture
0-30	1925	97.7
0-40	1961	99.6
0-60	1969	100
0-90	1970	100
90-180	0	0
0-180	1970	100

35° with LAR35FL optic and 4LSQA1H reflector	
Test Number	P1212213
Housing	LDSQA4A20935D010TE
Module	LAR35FL
Trim	4LSQA1H
Lumens	1996 Lm
Efficacy	69.3 Lm/W
SC	0.63

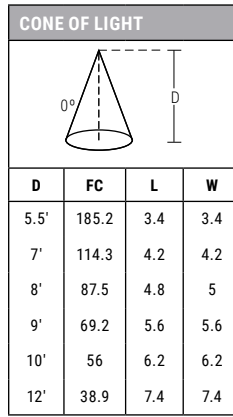
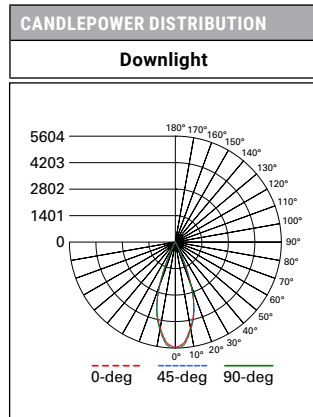

Degrees Vertical	Candela
0	5602
5	5362
15	3766
25	644
35	37
45	6
55	2
65	1
75	0
85	0
90	0

Zone	Lumens	% Fixture
0-30	1949	97.6
0-40	1987	99.6
0-60	1995	99.9
0-90	1996	100
90-180	0	0
0-180	1996	100

Photometric Data

15° with LAR15SP optic and 4LSQA1H reflector - 30° Tilt

Test Number	P1212204
Housing	LDSQA4A20935D010TE
Module	LAR15SP
Trim	4LSQA1H
Lumens	1644 Lm
Efficacy	57.1 Lm/W
SC	0.6

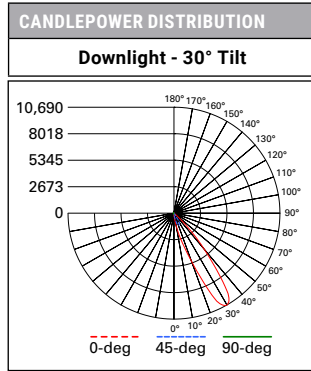

0° AIMING ANGLE HORIZONTAL ILLUMINANCE ON FLOOR

D	FC	L	W
5.5'	239.5	2.2	2
7'	147.8	2.8	2.4
8'	113.2	3.3	2.8
9'	89.4	3.6	3.2
10'	72.4	4.1	3.6
12'	50.3	4.9	4.4

30° AIMING ANGLE HORIZONTAL ILLUMINANCE ON FLOOR

D	FC	L	W	CB
5.5'	57	5.8	3	3.2
7'	35.2	7.3	3.8	4
8'	26.9	8.3	4.4	4.6
9'	21.3	9.5	5	5.2
10'	17.2	10.4	5.6	5.8
12'	12	12.5	6.8	6.9

30° AIMING ANGLE VERTICAL ILLUMINANCE ON WALL

D	FC	L	W	CB
1'	7212.2	0.3	0.2	1.7
2'	1803	0.8	0.6	3.5
3'	801.4	1.1	1	5.2
4'	450.8	1.6	1.4	6.9
5'	288.5	1.9	1.8	8.7
6'	200.3	2.4	2.2	10.4

CANDELA TABLE

Degrees Vertical	Candela
0	142
5	235
15	2691
25	9131
35	8980
45	1612
55	21
65	2
75	2
85	0
90	0

ZONAL LUMEN SUMMARY

Zone	Lumens	% Fixture
0-30	781	47.5
0-40	1423	86.5
0-60	1634	99.4
0-90	1644	100
90-180	0	0
0-180	1644	100

25° with LAR25NF optic and 4LSQA1H reflector - 30° Tilt

Test Number	P1212208
Housing	LDSQA4A20935D010TE
Module	LAR25NF
Trim	4LSQA1H
Lumens	1820 Lm
Efficacy	63.2 Lm/W
SC	0.59

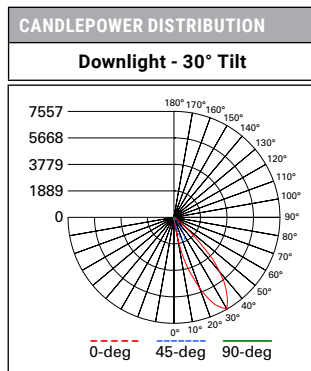

0° AIMING ANGLE HORIZONTAL ILLUMINANCE ON FLOOR

D	FC	L	W
5.5'	169.5	3.1	3
7'	104.7	4	3.8
8'	80.1	4.6	4.2
9'	63.3	5.2	4.8
10'	51.3	5.7	5.4
12'	35.6	6.9	6.4

30° AIMING ANGLE HORIZONTAL ILLUMINANCE ON FLOOR

D	FC	L	W	CB
5.5'	47.8	5.4	4.2	3.2
7'	29.5	6.7	5.4	4
8'	22.6	7.7	6.2	4.6
9'	17.9	8.5	7	5.2
10'	14.5	9.4	7.8	5.8
12'	10	11.2	9.4	6.9

30° AIMING ANGLE VERTICAL ILLUMINANCE ON WALL

D	FC	L	W	CB
1'	4963.5	0.5	0.4	1.7
2'	1240.9	1	1	3.5
3'	551.5	1.6	1.6	5.2
4'	310.2	2.2	2.2	6.9
5'	198.5	2.7	2.6	8.7
6'	137.9	3.3	3.2	10.4

CANDELA TABLE

Degrees Vertical	Candela
0	190
5	419
15	3750
25	6889
35	6554
45	2690
55	57
65	2
75	2
85	0
90	0

ZONAL LUMEN SUMMARY

Zone	Lumens	% Fixture
0-30	859	47.2
0-40	1498	82.3
0-60	1810	99.4
0-90	1820	100
90-180	0	0
0-180	1820	100

Photometric Data

35° with LAR35FL optic and 4LSQA1H reflector - 30° Tilt	
Test Number	P1212212
Housing	LDSQA4A20935D010TE
Module	LAR35FL
Trim	4LSQA1H
Lumens	1854 Lm
Efficacy	64.4 Lm/W
SC	0.59

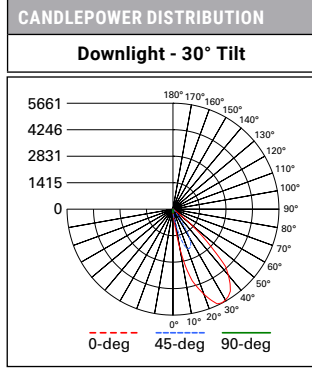

0° AIMING ANGLE HORIZONTAL ILLUMINANCE ON FLOOR				
D	FC	L	W	
5.5'	137.7	3.6	3.6	
7'	85	4.5	4.6	
8'	65.1	5.2	5.2	
9'	51.4	5.9	6	
10'	41.6	6.5	6.6	
12'	28.9	7.8	8	

30° AIMING ANGLE HORIZONTAL ILLUMINANCE ON FLOOR					
D	FC	L	W	CB	
5.5'	46.4	5.1	4.8	3.2	
7'	28.6	6.5	6	4	
8'	21.9	7.4	7	4.6	
9'	17.3	8.4	7.8	5.2	
10'	14	9.4	8.6	5.8	
12'	9.7	11.3	10.4	6.9	

30° AIMING ANGLE VERTICAL ILLUMINANCE ON WALL					
D	FC	L	W	CB	
1'	3990.3	0.5	0.6	1.7	
2'	997.6	1.2	1.2	3.5	
3'	443.4	1.9	2	5.2	
4'	249.4	2.4	2.6	6.9	
5'	159.6	3.1	3.4	8.7	
6'	110.8	3.8	4	10.4	

CANDELA TABLE	
Degrees Vertical	Candela
0	216
5	567
15	3967
25	5594
35	5360
45	3029
55	59
65	2
75	2
85	0
90	0

ZONAL LUMEN SUMMARY		
Zone	Lumens	% Fixture
0-30	868	46.8
0-40	1480	79.8
0-60	1844	99.4
0-90	1854	100
90-180	0	0
0-180	1854	100

Connected Systems

WaveLinx LITE - WLST Tilemount Sensor

WaveLinx LITE devices only compatible with the WaveLinx LITE system.

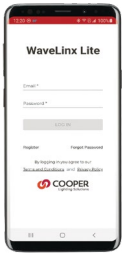

- Intuitive Android™ or Apple® iOS® app for basic system code compliant set up and configuration via Bluetooth
- Up to 28 unique areas per project site (WaveLinx LITE Bluetooth network)
- Up to 50 devices for an area, any one of 16 control zones, up to 6 occupancy sets, and custom lighting scenes
- Automatic occupancy or vacancy, sensor sensitivity, daylight dimming, etc. configurable through the app
- Refer to the WaveLinx system specifications for details



WaveLinx LITE WLST Tilemount Wiring Diagram

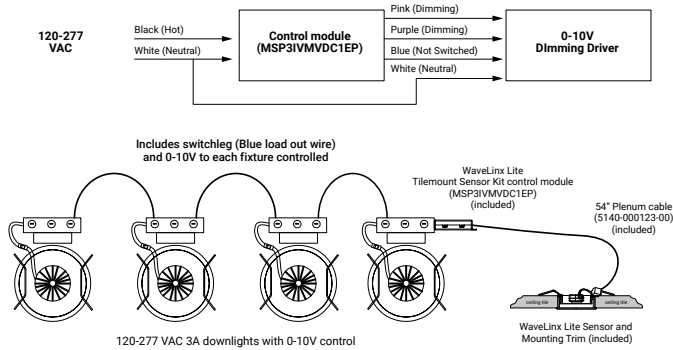

WaveLinx LITE Bluetooth Enabled System



WaveLinx PRO Wireless – WPST Tilemount Sensor

WaveLinx PRO devices only compatible with the WaveLinx PRO system.



- WaveLinx PRO Wireless functionality configures zones and customizes settings from one secure mobile app
- Automatic code commissioning that meets the strictest codes
- Fixtures and sensors integrate with Wireless Area Controller, Wall Stations, and Control Devices
- Stand-Alone Offices or Entire Building Network Installations



WaveLinx mobile app settings

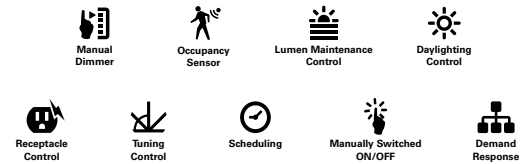

WaveLinx PRO WPST Tilemount Wiring Diagram

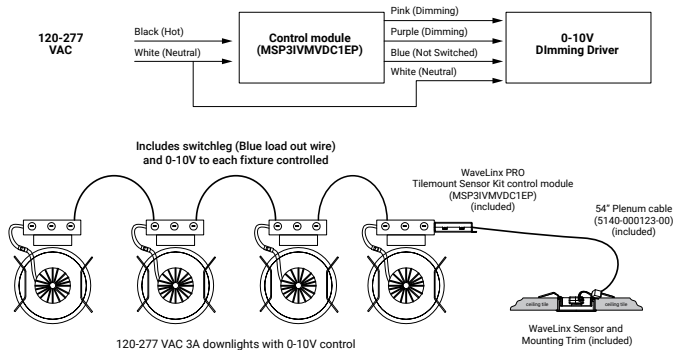

WaveLinx CORE Building Management Integration

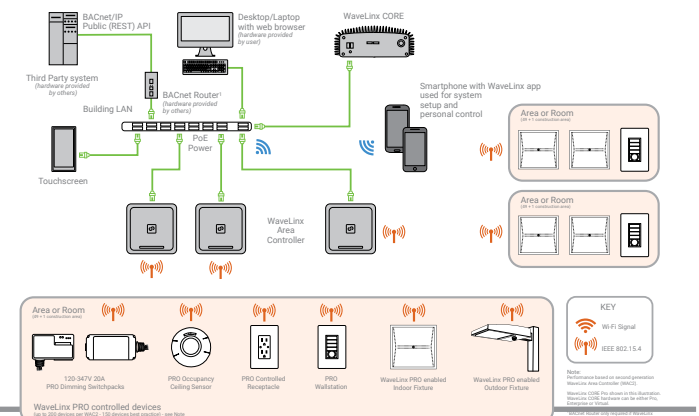

Connected Solutions



WaveLinX LITE Wireless Node - WLN

WaveLinX LITE devices only compatible with the WaveLinX LITE system.

- Intuitive Android™ or Apple® iOS® app for basic system code compliant set up and configuration via Bluetooth
- Up to 28 unique areas per project site (WaveLinX LITE Bluetooth network)
- Up to 50 devices for an area, any one of 16 control zones, up to 6 occupancy sets, and custom lighting scenes
- Refer to the WaveLinX system specifications for details
- Not available with BioUp or Tunable White

WaveLinX mobile app settings



WaveLinX LITE Wireless Node (WLN) Wiring Diagram

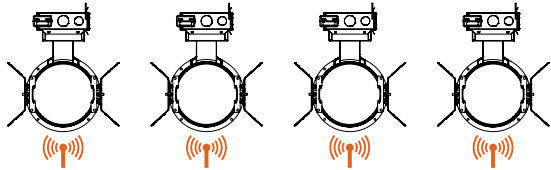
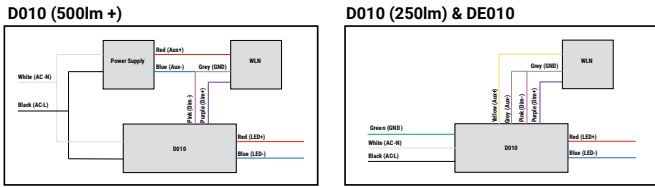

120-277 VAC 3A downlights with 0-10V control

WaveLinX LITE Bluetooth Enabled System



WaveLinX PRO Wireless Node - WPN

WaveLinX PRO devices only compatible with the WaveLinX PRO system.

- WaveLinX Wireless functionality configures zones and customizes settings from one secure mobile app
- Automatic code commissioning that meets the strictest codes
- Fixtures and sensors integrate with WaveLinX Area Controller, Wall Stations, and Control Devices
- Stand-Alone Offices or Entire Building Network Installations

WaveLinX mobile app settings

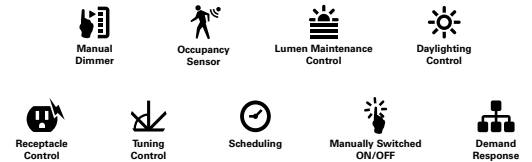

WaveLinX PRO Wireless Node (WPN) Wiring Diagram

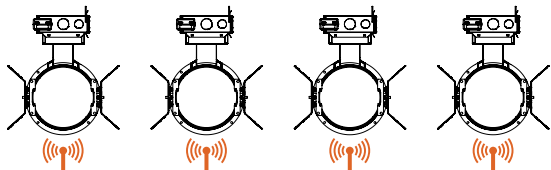
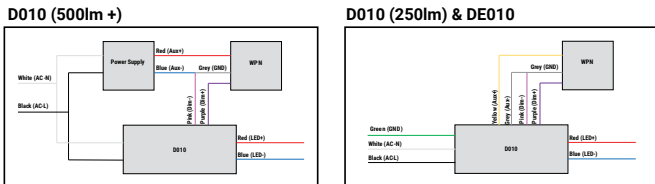

120-277 VAC 3A downlights with 0-10V control

WaveLinX CORE Building Management Integration

