

Project		Catalog #		Type	
Prepared by		Notes		Date	

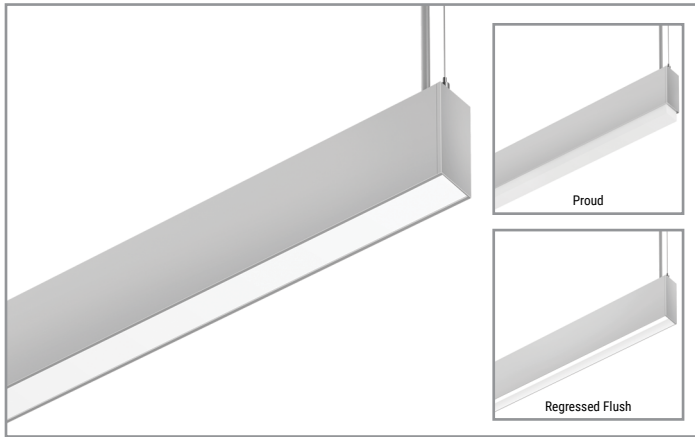

NeoRay

Define 2

2" LED
Suspended Pendant
Direct

Typical Applications

Office • Education • Healthcare • Hospitality • Retail

Interactive Menu

- Order Information [page 2](#)
- Product Specification [page 3](#)
- Photometric Data [page 4](#)
- Performance Data [page 5](#)
- VividTune [page 7](#)
- BioUp [page 9](#)



Top Product Features

- Suspended Slot family in 2", 3", 4" and 5" housing sizes
- Specifiable to the nearest foot
- Satin, Asymmetric and Drop Direct Lensing available
- Independently specifiable Direct / Indirect lumen packages
- 0-10V dimming standard; DALI dimming available
- 2700K, 3000K, 3500K, 4000K, and 5000K correlated color temperatures available
- Available in VividTune and BioUp Technology
- Options to meet Buy American Act requirements

Dimensional and Mounting Details

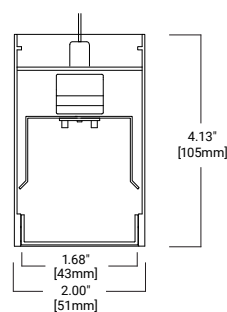

Standard Housing

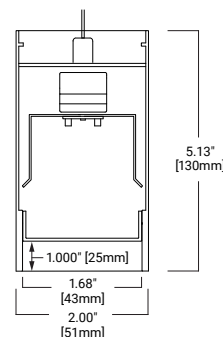

Regressed Housing

[additional product diagrams](#)

Order Information

Icon Key: Grey bar denotes available with 10-Day Quick Spec
 ∅ Consult factory for availability

SAMPLE ORDER NUMBER: **S122DP-C675D835-C4JB4F0-1T-UDD-F-W-WPS**

Domestic Preference	Series	Light Engine	Lumen Package Down (Lms/ft)	CRI	LED CCT	Suspension Type	Ceiling Type	Mounting HW Color
[Blank]=Standard BAA=Buy American Act	QS- S122DP=Define 2 Direct Pendant Quick Spec S122DP=Define 2 Direct Pendant S122RDP=Define 2 Regressed Direct Pendant	-C=Core -H=High Performance -V=VividTune ∅ -B=BioUp	290D=290 Lms/ft (2.9W/ft) 485D=485 Lms/ft (4.8W/ft) 675D=675 Lms/ft (6.7W/ft) 865D=865 Lms/ft (8.8W/ft) 1005D=1005 Lms/ft (10.6W) ___D=Custom Lms/ft ∅	8=80 9=90 B=BioUp	27=2700K 30=3000K 35=3500K 40=4000K 50=5000K 2765=2700K-6500K 3050=3000K-5000K 2750=2700K-5000K	-C4=4ft Aircraft Cable -C10=10ft Aircraft Cable -C20=20ft Aircraft Cable -S4=4ft Stem Mount -S8=8ft Stem Mount	JB=Gypsum Board, Junction Box, Structure T1=15/16" T-Grid (ETG) T9=9/16" T-Grid (FTG) TS=9/16" Slot (STG), Tegular (FTT), Interlude (ITG)	(blank)=White B=Black
Notes Only product configurations with this designated prefix are built to be compliant with the Buy American Act of 1933 (BAA). Please refer to DOMESTIC PREFERENCES website for more information. Components shipped separately may be separately analyzed under domestic preference requirements.	Notes RDP regress of 1" will add an additional 1" to fixture depth.	Notes See performance table for add'l details. Light engine must be consistent across run length. V option requires lumen package of 675 lms/ft or greater.	Notes 3500K/80CRI/DIP/F Lens. Please refer to scaling data for other variables. For custom lumen output, please refer to additional information on page 5. 290 Lms/ft not available on 2ft fixture length. Refer to BioUp Driver Tables on page 8 for light level availability.	Notes Additional lead-time and cost may apply for 927, 930, 935 and 940 configurations. 92765 and 93050 VividTune configurations require V light engine and W2A driver. B35, B40, B50, B2750 BioUp configurations require B light engine. CRI ranges from >80CRI to 96CRI in BioUp Technology and is correlated to Color Temperature.		Notes	Notes	Notes White mounting hardware standard

Luminaire Length (Ft)	Max section length	Circuiting	Additional Section Wiring	Voltage	Driver Type	Shielding Down
2F0=2' Nominal Length 4F0=4' Nominal Length 8F0=8' Nominal Length ___F0=4' Incremental Run (e.g. 40F0 = 40' 0") ___F0=1' Incremental Run (e.g. 39F0 = 39' 0")	[Blank]=12ft (std) /8=8ft	-1=Single Circuit -S=Secondary Circuit	E=Emergency Circuit B3=6W UNV Integral T=UL924 EPC Emergency Bypass Relay	-U=Universal (120V-277V) -1=120V -2=277V -3=347V	DD=Standard 0-10V Dimming (1%-100%) 5L=Fifth Light DALI (1%-100%) LH=Lutron HiLume (LDE1 series) 1%-100% EcoSys W2A=2-Channel 0-10V (VividTune and Dynamic BioUp Only) W2D=2-Channel DALI (Dynamic BioUp Only)	-F=Satin White Diffuser -D=Satin Drop diffuser -A=Asymmetric Diffuser -L=Straight Blade Diffuser w/ diffuser ∅ -W=Wall Wash
Notes Minimum fixture length is 2ft. Specify to nearest foot in length. Refer to BioUp Driver Tables on page 8 for minimum allowable lengths.	Notes Individual fixtures configured as 12ft max by default. Continuous runs configured as 8ft max (12ft not available).	Notes Secondary circuit similar to A/B switching. Price adder applies for "S" configuration.	Notes Battery available on fixture ≥ 4ft in length. B3 and T options not compatible with 347V. Standard battery 4ft battery section located in the beginning of the fixture, but can be relocated using the linear product configurator. B1 and B2 battery options not available with W2D driver in BioUp Technology	Notes 347V only available with DD driver option.	Notes Use standard 0-10V (DD) for Static BioUp (B35 B40 B50). 2-Channel 0-10V (W2A) available with VividTune (V) and Dynamic BioUp (B2750) only. 2-Channel DALI (W2D) available with Dynamic BioUp (B2750) only	Notes All lensing options are snap-in lenses. "L" option required RDP series and will require additional lead-time, please consult factory for details. A and W option not available with VividTune. W option not available with Regressed (1in) housing.

Finish	Integrated Sensor
W = White S = Silver B = Black RR = Real Red OO = Oasis Orange YY = Yippee Yellow GG = Gracious Green CC = Cyprus Cyan TT = Totally Turquoise BB = Biosphere Blue PP = Perfect Purple VV = Vacation Violet MM = Magic Magenta C = Custom Color (RAL) CM = Custom Color (Match)	[Blank] = None WaveLinx Wireless -WLS (formerly WAB) = WaveLinx LITE Wireless Sensor, Occupancy w/ photocell, Independent & Networked -WPS (formerly WAA) = WaveLinx PRO Wireless Sensor Occupancy w/ photocell, Networked -WLN = WaveLinx LITE Wireless Control Node, without Sensor -WPN = WaveLinx PRO Wireless Control Node, without Sensor
Notes Custom Colors (C and CM) are available as ETO. Performance is based off White (W) and may vary with selected finish.	Notes DD driver must be selected. Please refer to page 6 for additional detail required to specify integrated sensors. Integral option not available with regressed or drop lensing. WPS and WLS sensor options are also available with W2A BioUp Dynamic Option.

Product Specifications

Construction

- Available in Flush and Regressed Housing
- Precision cut housing extruded from 6063 aluminum
- Precision cut & welded end-caps ensure a robust and clean construction
- Nominal 2' -12' illuminated sections used in individual fixtures and 2'-8' illuminated sections used in continuous runs

Finish

- Electrostatically applied polyester powder coat paint

LED Module

- Modular LED tray assembly comprising reflector and light engine with quick disconnect wire-harness for ease of installation and maintenance over the life of the luminaire

Light Engine

- Offered with two next generation Neo-Ray light engines delivering industry leading efficacy and long-life
- LED's are available in 2700K, 3000K, 3500K, 4000K or 5000K
- CRI options of either ≥80CRI or ≥90CRI (Lumen output will be affected - please refer to the lumen adjustment factor table)

LED Drivers

- LED system coupled with electrical driver
- Traditional electronic drivers are available for 120-277V and 347V applications

Controls and Integrated Sensors

- Equipped standard with a 0-10V continuous dimming driver. Compatible with most standard dimming devices
- Additional control types are available (DALI & Lutron) at an additional cost
- WaveLinX and Enlighted wireless sensors as well as stand-alone sensors available

Mounting

- Suspended

Lengths

- Available in any length (2ft min) with a resolution of 1 foot. Max section length of 12ft (8ft max used on continuous runs and available for individual fixtures)
- Additional fixture lengths are available please consult factory. All lengths are nominal and do not include end caps.

Corners and Transition Pieces

- Corners and other transition pieces are fully luminous
- Constructed using precision mitered housing and lens components
- Extrusions are welded to ensure a precise and robust assembly
- Standard 90° horizontal corners as well as custom corners are available
- Consult online linear configurator or the factory for precise corner locations and for ordering
- Alternative transition pieces such as T's, Y's, X's, etc. are also available Ø

Direct Snap-In Lensing Options

- Satin Flush - Flush, high diffusion glare-free lens
- Satin Drop - 1" Drop, high diffusion glare-free lens
- Asymmetric - Flush, low-glare Asymmetric lens
- Flush options ship with our patent-pending underlens solution, the proud lens ships with an injection molded end cap to eliminate light leak

Reflectors

- Precision formed cold-rolled steel reflectors with high reflectivity
- Ultra high reflectivity used with High Performance light engine

Lumen Maintenance

- 90% (L90) of initial light output at 61,000+ hrs
- 70% (L70) of initial light output at 237,000+ hrs
- Derived from TM-21 standard @25°C for worst case operating conditions

Custom Lumen Output

- Custom lumen output expressed option in Lumens per foot (e.g. -725D for 725 Lms/ft down). Refer to additional detail on page 5.

Electrical

- Dimming provided as standard
- Dimming wires capped with wire-nuts for non-dimming applications
- Optional battery backup options provided
- Default battery location is internal to fixture
- Default emergency section is 4ft in length and located at the beginning of the fixture unless designated elsewhere
- Estimated lumen output = battery wattage * min efficacy (see performance table)
- The EPC option will bypass local controls and dimming upon loss of normal power. This option is required when the fixture has both integrated sensors and emergency circuiting

Integrated Sensors

- Please reference page 6 for details

Weight

- 3.0 lbs per foot

Approvals

- cULus - listed for damp locations
- Meets NYC requirements
- Meets CCEC requirements
- Tested to IESNA LM-79 and LM-80
- Can be used for State of California Title 24 high efficacy luminaire
- DesignLights Consortium® Qualified and classified for DLC Standard refer to www.designlights.org for details and listed configurations.

Warranty

- Five year warranty standard.

Standard Finish Options

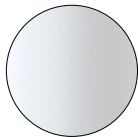

W - White

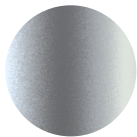

S - Silver

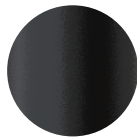

B - Black



RR - Real Red
RAL 3020
Gloss



OO - Oasis Orange
RAL 2004
Gloss



YY - Yippee Yellow
RAL 1018
Gloss

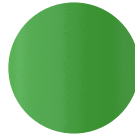

GG - Gracious Green
RAL 6018
Gloss

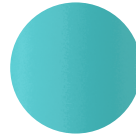

CC - Cyprus Cyan
RAL 6027
Gloss

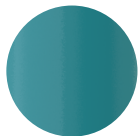

TT - Totally Turquoise
RAL 5018
Gloss

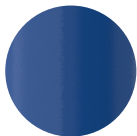

BB - Bioshere Blue
RAL 5017
Gloss



PP - Perfect Purple
RAL 4005
Gloss



VV - Vacation Violet
RAL 4008
Gloss



MM - Magic Magenta
RAL 4010
Gloss

RAL & custom colors available as ETO

Optic Options

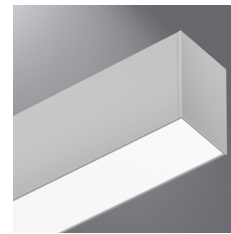

Standard Flush Lens



Standard Proud Lens

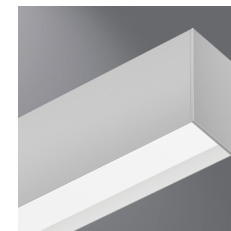

Regressed Flush Lens



Asymmetric Lens

Photometric Data - Static White LED Technology

 [View IES files](#)

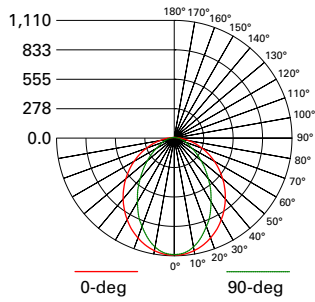

FILE NAME:
S122RDP-S675D835-4F0-1E-UDD-F
LUMENS: 2272.6 Lms
LPW: 86.4 LPW
CCT: 3500K
WATTS: 26.3 W
TEST NUMBER: P333887

SATIN FLUSH LENS

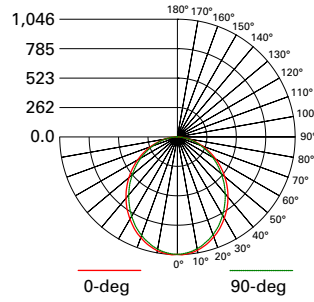

FILE NAME:
S122DP-S675D835-4F0-1E-UDD-F
LUMENS: 2645.9 Lms
LPW: 100.6 LPW
CCT: 3500K
WATTS: 26.3 W
TEST NUMBER: P333817

SATIN REGRESSED DIFFUSER

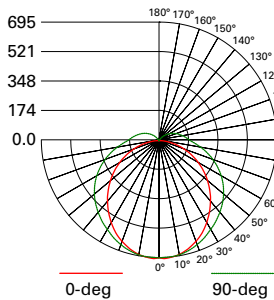
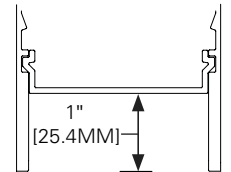

FILE NAME:
S122DP-S675D835-4F0-1E-UDD-D
LUMENS: 2632.8 Lms
LPW: 100.1 LPW
CCT: 3500K
WATTS: 26.3 W
TEST NUMBER: P333782

SATIN DROP LENS

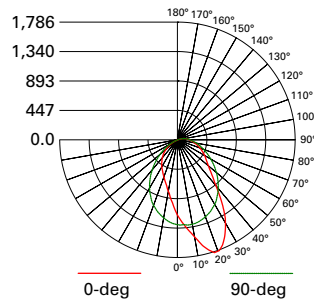
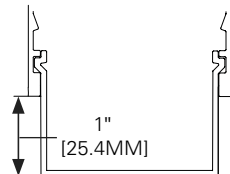

FILE NAME:
S122DP-S675D835-4F0-1E-UDD-A
LUMENS: 2870.4 Lms
LPW: 109.1 LPW
CCT: 3500K
WATTS: 26.3 W
TEST NUMBER: P333747

ASYMMETRIC FLUSH LENS

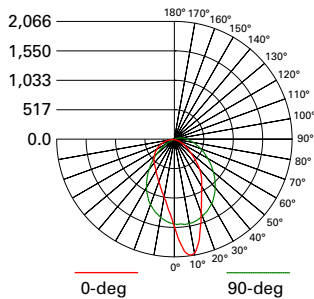

FILE NAME:
S122DR-C675D835-EGT4F0-1D-UDD-WW-W
LUMENS: 2960.4 Lms
LPW: 113.9 LPW
CCT: 3500K
WATTS: 26 W
TEST NUMBER: G3-2308-143-1

WALL WASH LENS



Photometric Overview and Performance Data

Direct Performance Per Linear Foot at 3500K/80CRI

Nominal Output	Standard		High Performance		VividTune	
	W/ft	lm/W	W/ft	lm/W	W/ft	lm/W
290	2.9	105	2.9	108	3	102
485	4.8	106	4.4	111	4.9	103
675	6.7	104	6.1	111	6.7	102
865	8.8	102	8.1	109	8.9	99
1005	10.6	98	9.7	105	10.7	96

LUMEN ADJUSTMENT CALCULATIONS

Example 1 - Adjusted Lumen Output

Nominal Lumen Output selected = 1025 lms/ft (based on standard of 3500K/80CRI)

Lumen Adjustment Factor = 0.801 (2700K/90CRI desired)

Adjusted Lumen Output = Nominal Lumen Output x Lumen Adjustment Factor

Adjusted Lumen Output = 1025 lms/ft x 0.801 = 821 lms/ft

Example 2 - Custom Lumen Output based on Required Lumens Per Foot

Total light output (4ft) requirement of 2800 lms, desired CCT and CRI of 4000K/80CRI

Total required lumens per foot @ 4000K = 2800 lms / 4 ft = 700 lms/ft

Lumen Adjustment Factor = 1.018 (Requirement based on 4000K / 80CRI)

Total required lumens per foot @ 3500K / 80CRI = 700 lms/ft ÷ 1.018 = 688 lms/ft

Estimated efficacy = 121 LPW (find nearest value using table above)

Estimated power consumption = 688 lms/ft ÷ 121 lm/W = 5.69 W/ft

Custom Lumen Output

Total Light Output Range (lms/ft)

CCT	Lumen Adj Factors		Direct Output Range	
	80CRI	90CRI	80CRI	90CRI
2700K	N/A	0.792	N/A	230-796
3000K	0.943	0.815	273-948	236-819
3500K	1.000	0.861	290-1005	250-865
4000K	1.010	0.892	293-1015	259-896
5000K	1.010	0.892	293-1015	259-896

If your requirement is expressed in power consumption (W/ft) rather than light output, you can use the power to lumen output curves to convert power consumption to light output for specification. Efficacy for custom lumen outputs can be estimated using lumen output curves or with the use of our online custom lumen output tool.

Lumen Adjustment Factors

Direct Optic	Adjustment Factor
Flush Frosted Lens (F)	1.000
Asymmetric (A)	1.085
Drop (D)	0.995
Regress Frosted (RD w/ F)	0.859
Wall Wash (W)	1.097

Corner Transitions

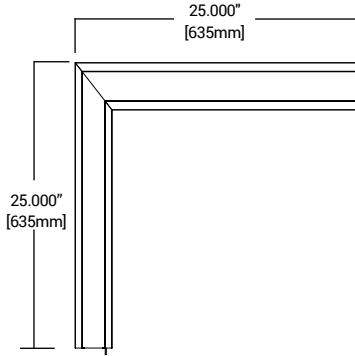

Integrated Sensor Details and Placement

Sensor Type	Wireless	Sensor Integration	Sensor Mounting	Ordering Code
WaveLinx Pro	Yes	Integral to Fixture	Mounted in solid cover	WAA
WaveLinx Lite	Yes	Integral to Fixture	Mounted in solid cover	WAB
Enlighted	Yes	Integral to Fixture	Mounted in illuminated lens	LWIPD1
Stand-Alone SVPD1	No	Integral to Fixture	Mounted in solid cover	SVPD1

Optional standalone and wireless connected integrated sensors require use of the DD (0-10V) driver. WaveLinx and Enlighted sensors require additional system hardware (not provided) for full functionality.

Standard sensor layout is shown below. Please refer to sensor coverage pattern diagrams to ensure proper coverage for the application. Standard configurations are available in both individual fixtures and in continuous runs. Default spacing is based on the maximum fixture length of 12ft and can be changed to 8ft sensor spacing for additional coverage by selecting the 8ft max fixture length option when ordering.

For additional information integrated sensors and connected lighting, please visit [Cooper Lighting Solutions's Connected Lighting Website](#).

- Standard Sensor with Luminaire Control
- Auxiliary Sensor used for Sensor Coverage (wireless systems only)

INTEGRAL SENSOR

≤8ft Individual

>8ft Individual

Note: When 8ft max section length is used on individual fixtures > 8ft, sensor placement follows logic for continuous run.

Beginning of Run (BOR)

Intermediate Section (INT)

End of Run (EOR) > 4ft

End of Run (EOR) ≤ 4ft



Define 2 Pendant LED with VividTune Tunable White

VividTune tunable white luminaires deliver high-quality light in a broad range of continuously variable color temperatures and intensities. Create a dynamic environment by adjusting the ambient light warmer or cooler to influence mood, support the task at hand, or create a dramatic ambience. The ability to control correlated color temperature and intensity separately using simple controls is the next evolution of LED lighting for the commercial, educational, healthcare and hospitality space. The unparalleled flexibility and number of available lighting environments enable users to find the right light with tunable white.

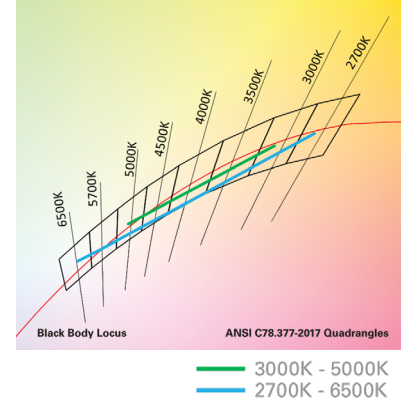

Performance Data*

Tunable White - Lumen Adjustment Factors				
CCT	3000K-5000K		2700K-6500K	
	80 CRI	90 CRI	80 CRI	90 CRI
2700K	-	-	0.868	0.741
3000K	0.894	0.736	0.893	0.771
3500K	0.946	0.804	0.924	0.809
4000K	0.993	0.868	0.944	0.835
4500K	1.002	0.883	0.961	0.857
5000K	1.002	0.883	0.974	0.874
6500K	-	-	0.988	0.897

Example of Approximate Lumen Calculation			
	Standard Catalog #	VividTune 80 CRI Catalog #	VividTune 90 CRI Catalog #
CCT Setting	S122DP-C865D835-X-UDD-F-W	S122DP-V865D83050-X-UW2A-F-W	S122DP-V865D93050-X-UW2A-F-W
3000K	-	3093	2547
3500K	3460	3273	2782
4000K	-	3436	3003
4500K	-	3467	3055
5000K	-	3467	3055

Controlling VividTune Tunable White

VividTune luminaires make tunable white more accessible by using simple and familiar controls. From wall dimmers to wireless controls, VividTune tunable white luminaires are compatible with industry standard 0-10V dimming controls. A single 0-10V dimming input is used to control intensity (brightness) while a second 0-10V dimming input is used to adjust CCT. For suggested control configurations, go to www.cooperlightingsolutions.com for tunable white application guides.

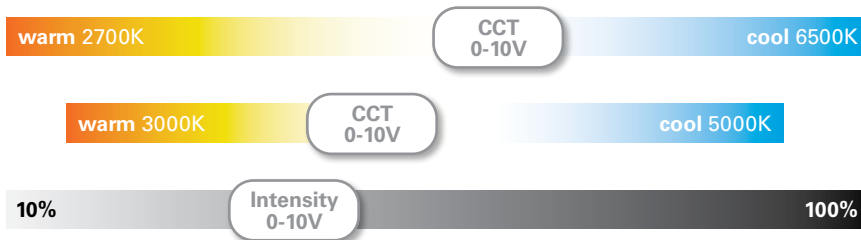

Example of Lumen Adjustment Calculation

S122DP-V865D83050-X-UW2A-F-W at 80 CRI tuned to 3500K

Adjusted Lumen = published lm x adjusted lm factor

Adjusted Lumen = 3460 x 0.946

Adjusted Lumen = 3273 lm

* Lumen adjustment factors are for reference and may be different for each product selected. Refer to IES files for actual performance data on each.

BioUp Photometry

Legend: • Available
- Unavailable

2in	DIRECT	
Nominal Output	BioUp Light Engine	B35 efficacy
lm/ft	W/ft	lm/W
290	-	-
485	5.9	82.2
675	8.6	78.5
865	11.1	77.9
1005	15.0	67.0

0-10V						
Availability						
Lumens/ft	290	485	675	865	1005	
Fixture Length	2	-	-	•	•	•
	3	-	•	•	•	•
	4	-	•	•	•	•
	5	-	•	•	•	•
	6	-	•	•	•	•
	7	-	•	•	•	•
	8	-	•	•	•	•
	9	-	•	•	•	•
	10	-	•	•	•	•
	11	-	•	•	•	•
	12	-	•	•	•	•

DALI						
Availability						
Lumens/ft	290	485	675	865	1005	
Fixture Length	2	-	•	•	•	-
	3	-	•	•	•	-
	4	-	•	•	•	-
	5	-	•	•	•	-
	6	-	•	•	•	-
	7	-	•	•	•	-
	8	-	•	•	•	-
	9	-	•	•	•	-
	10	-	•	•	•	-
	11	-	•	•	•	-
	12	-	•	•	•	-

Proven Research. Industry Recognized.

BioUp

Melanopic Lighting



See better



Feel better



Function better



See [BioUp brochure](#) for more details

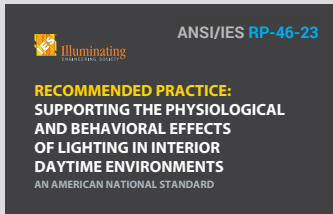

ANSI/IES RP-46-23 / TM18 published March 2024 based on over 40 years of research.

"...circadian clock synchronization is paramount to the body's efficient and appropriate functioning." – TM18



BioUp solutions maximize WELL points for Circadian Lighting Design (L03):

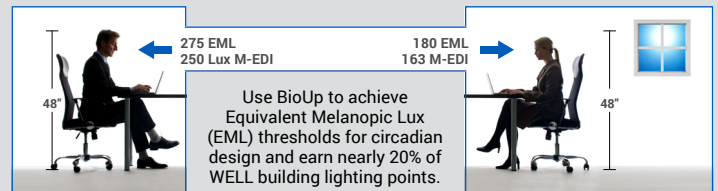

MDER, M-EDI and EML are key metrics used to quantify non-visual performance of indoor lighting systems.

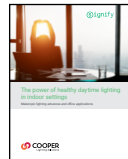

See [BioUp white paper](#) for more details

30% boost Biological impact compared to traditional LED sources

CCT	LED MDER ~83 CRI	BioUp Static		BioUp Dynamic	
		MDER	CRI	MDER	CRI
2700K	0.44	–	–	0.43	95
3000K	0.49	–	–	0.54	94
3500K	0.56	0.71	90	0.71	90
4000K	0.64	0.84	87	0.82	87
5000K	0.77	0.98	84	0.98	84

BioUp enhances the LED spectrum with cyan light at 475nm increasing the biological impact of the light to enhance our circadian rhythm which regulates our sleep/wake cycle, daytime engagement, and mood – **all without distorting visual color impression.**

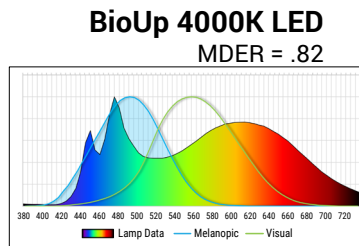
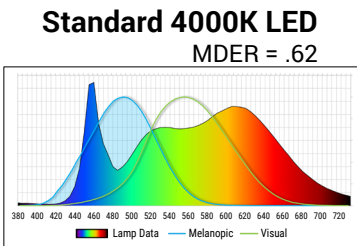

Static (non-tunable)

Static BioUp is used when simple Melanopic Lighting is desired at all times.

Arrow in graph shows BioUp spectrum boost is at 475nm where non-visual biological response is enhanced.

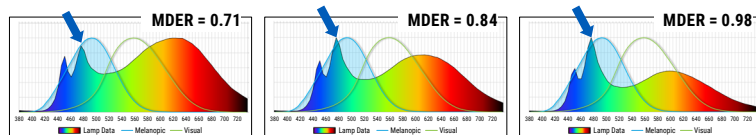

3500K or **4000K** or **5000K**

Cyan light component always present



no CCT control needed

Dynamic - (Tunable)

Dynamic BioUp is used when Melanopic Lighting is desired to adjust during the day.

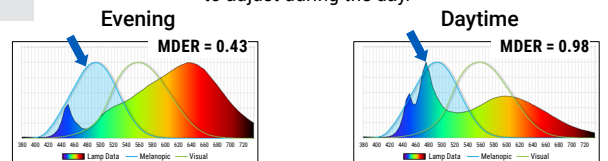

Warmer CCT Without Cyan content ← → Cooler Light With Cyan content

2700K – 5000K



Control with Wavelinx, 2ch 0-10V, or DALI