

Project		Catalog #		Type	
Prepared by		Notes		Date	

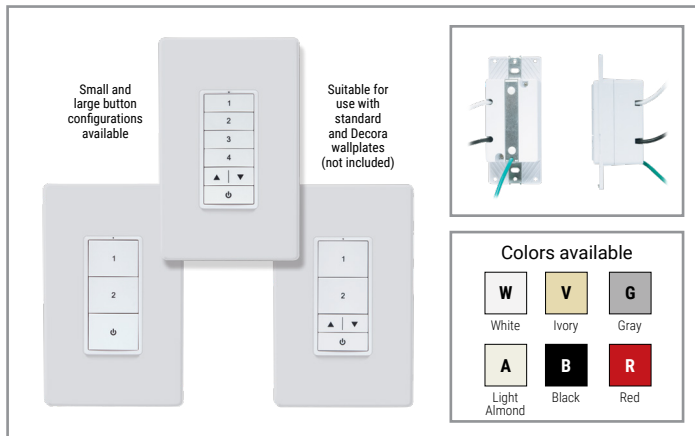

WaveLinX

LITE Line Voltage Wallstation (WWL-Series) and colored wallstations (WST series)

Multi-scene, single area dimming wallstation which provides customized light level for each area

Typical Applications

Office • Education • Hospitality • Retail • Industrial • Manufacturing

Interactive Menu

- Order Information page 2
- Button Options page 2
- Additional Resources page 3
- Connected Systems page 4
- Product Warranty



- Meets latest ASHRAE Standard 90.1 requirements
- Meets latest IECC requirements
- Meets latest CEC Title 24 requirements

Product Features



Compatibility



Overview

The wallstation is an integral part of the WaveLinX LITE system and is available in small and large button configurations. These wallstations are mains (120-277VAC) powered and provide wireless control of the lighting in an area. The wallstations operate on a wireless mesh network based on IEEE 802.15.1 (Bluetooth® 4.2 Low Energy) standards.

The wallstation mounts in a standard wallbox (single or multi-gang) suitable for use with standard wallplates (not included). Each wallstation is fully configurable to provide local control in each area. Each button is configured to control a lighting scene or zone for an area and can be modified using the WaveLinX LITE application.

The wallstation is a single area, multi-scene, multi-zone capable area dimming wallstation which provides customized light level for an area. Wallstation models provide default sequence of operations including 50% light level, scene light levels between 30-70% as well as 100% and full off. Two wallstation configurations also include raise/lower buttons to manually adjust the area light levels.

Product Features & Benefits

- Multi-scene selection, raise/lower, off for an area
- Suitable for standard single or multi-gang NEMA wall box
- Line voltage (120-277VAC) powered with no batteries to replace for simple new or retrofit installations
- Numbered buttons provide zone configuration capabilities
- 5 Color options available
- Configurable through software - no physical adjustments
- WaveLinX LITE is DLC Listed for interior applications - meeting the NLC5 Technical Requirements

Order Information

WaveLinx LITE Wallstations are accessories to the WaveLinx LITE system which may be commissioned via the WaveLinx LITE mobile application.

WaveLinx LITE devices are not currently compatible with the WaveLinx Area Controller.

SAMPLE ORDER NUMBER: **WST-L-3D-R-120** (Wavelinx LITE, 3 Button Dimming, Red, Line Voltage)

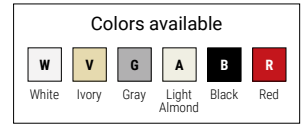

Catalog Number

Standard Wallstation Configurations

Catalog Number	Description
WWL3-W	WaveLinx LITE Wallstation, 3 Button, White
WWL3-RL-W	WaveLinx LITE Wallstation, 3 Button Raise / Lower, White
WWL5-RL-W	WaveLinx LITE Wallstation, 5 Button Raise / Lower, White
Notes	Notes
WaveLinx LITE application required to customize programming for each button.	Suitable for use with standard and Decora wallplates (not included). Complete wallstation - buttons are not field replaceable.

Custom Engraved Wallstation Configurations

Catalog Number	Description
WWL3-W-ENGRV	WaveLinx LITE Wallstation, 3 Button, White, Custom Engraved
WWL3-RL-W-ENGRV	WaveLinx LITE Wallstation, 3 Button Raise / Lower, White, Custom Engraved
WWL5-RL-W-ENGRV	WaveLinx LITE Wallstation, 5 Button Raise / Lower, White, Custom Engraved
Notes	Notes
WaveLinx LITE application required to customize programming for each button.	Suitable for use with standard and Decora wallplates (not included). For custom engraving use the configurator tool within the FlashPro Program (CUST-ENGRV). Complete wallstation - buttons are not field replaceable.

Colored Wallstation Configurations

Product	System Type	Button Configuration	Color	Power Supply	Custom Engraving
WST = Wallstation	L = LITE	3 = 3 Button 3D = 3 Button Dimming 5D = 5 Button Dimming	V = Ivory G = Gray A = Light Almond B = Black R = Red	120 = 120VAC	ENGRV = Custom Engraved
Notes					Notes
WaveLinx LITE application required to customize programming for each button. Suitable for use with standard and Decora wallplates (not included). Buttons are not field replaceable.					For configuring Custom Engraved wall stations, please use Configurable Spec Sheet .

Additional Accessories

Wallplates are not included with Wallstations. Please order separately.

Catalog Number

Catalog Number	Description
PJS26W	1 Gang Screwless Faceplate, White
PJS262W	2 Gang Screwless Faceplate, White
PJS263W	3 Gang Screwless Faceplate, White
PJS264W	4 Gang Screwless Faceplate, White
PJS265W	5 Gang Screwless Faceplate, White

Required Accessories

Download and register the WaveLinx LITE mobile application from either the Google Play or Apple Store. This mobile application can be used to form a lighting network - creating control zones, occupancy sets, setting occupancy or vacancy modes of operation, configuring daylighting, etc.



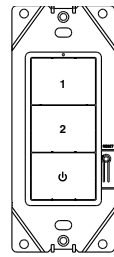

WWL3-W

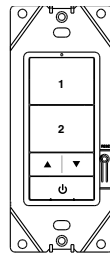

WWL3-RL-W

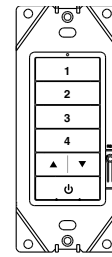

WWL5-RL-W

Standard button engraving for each wallstation

Default engraving & light levels

Button 1	Scene 3 = 50%
Button 2	Scene 1 = 100%
Button 3	Scene 2 = 70%
Button 4	Scene 4 = 30%
Raise press*	Increase 1% (per press)
hold*	Increase 15% (per sec)
Lower press*	Decrease 1% (per press)
hold*	Decrease 15% (per sec)
Power*	Scene 0 = OFF

* - affects all zones in area

Raise / Lower / OFF buttons

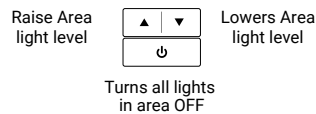

Button programming options via WaveLinx Lite Mobile Application

Scene Selection
Zone Level
Raise Level
Lower Level
No Action

Product Specifications

Key Features

- Easy installation and flexibility:
 - Scene selection
 - Zone control
 - Area Raise / Lower
 - OFF
- Suitable for standard single or multi-gang NEMA wall box (wallplate not included)
- Mains (120-277VAC) powered for simple new or retrofit installations
- Clean, elegant, and simple way to control lighting on your project
- Settings are programmable through software, no physical adjustments necessary

Mechanical

Size: 4.2"H x 1.8"W x 1.5"D (107mm x 45mm x 39mm)

Environment:

- **Operating temperature:** 32°F to 113°F (0°C to 45°C)
- **Storage temperature:** 32°F to 167°F (0°C to 75°C)
- **Relative humidity operating:** 5% to 95% non-condensing
- For indoor use only

Mounting: Standard decorator opening (wallplate not included)

Colors: White, Ivory, Gray, Light Almond, Black and Red

Electrical

Input power: 120-277VAC 50/60Hz (neutral wire required)

Input current: 5mA @120V and 5mA @277V

Hardware Specifications

Status Indicators:

- Single indicator LED
- LED functionality (active for 3 seconds after action)
 - Indication of wireless network join request
 - Indication of wireless network connection
 - Scene indication of operations

Button Configuration:

- 3 Button
- 3 Button with Raise / Lower
- 5 Button with Raise / Lower

Software Specifications

- Each button programmable to trigger Scene or Zone
- Default values when joined to a network (area) via WaveLinx LITE application
- Models available with dominant button 50% light level
- Secure firmware upgrade OTA from mobile application

Wireless Specifications

Radio: 2.4GHz

Standard: IEEE 802.15.1 - Bluetooth® 4.2 Low Energy (BLE)

Transmitter Power: +7dBm

Range: Device to device; 100ft (30m) LOS (best practice)

Note - metal wallplates will reduce wireless range

System Performance

Maximum number of nodes supported: Best practice of 40 devices, maximum of 50 devices per commissioned network

Standards/Ratings*

- cULus Listed - Energy Management Equipment (UL916)
- FCC Part 15, Subpart B & C
- Meets latest ASHRAE Standard 90.1 requirements
- Meets latest IECC requirements
- Meets latest CEC Title 24 requirements
- NEMA WD-7 and NEMA 4 compliant
- CA Title 20 and Prop 65 compliant
- RoHS
- WaveLinx LITE is DLC Listed for interior applications - meeting the NLC5 Technical Requirements

Warning

- This product is not intended to be used in applications involving the use of ammonia-based or VOC cleaners.
- Use of ammonia-based or VOC cleaners on this device must be avoided. Prolonged use may cause loss of integrity and expose electrified components. If this occurs, turn OFF power to the unit and replace.
- For detailed cleaning guidelines please refer to: Controls Care and Maintenance instructions at the end of this document.

Warranty

Five year warranty standard



Download the WaveLinx LITE Mobile App from either the Google Play or Apple Store*

Dimensional Details

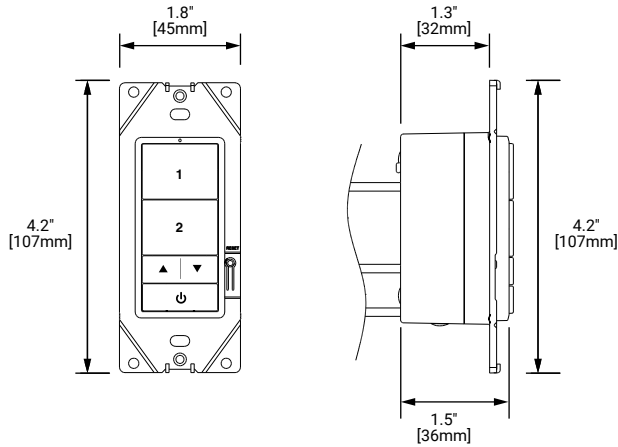

Installation

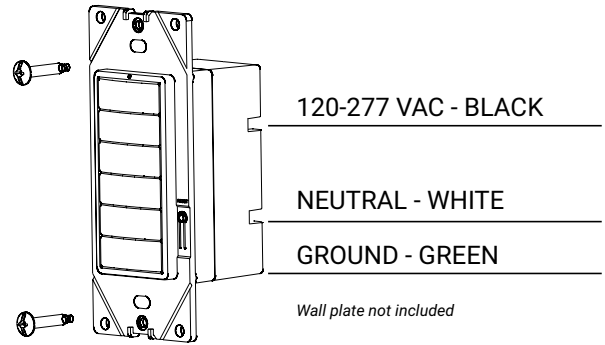

Mounting Height

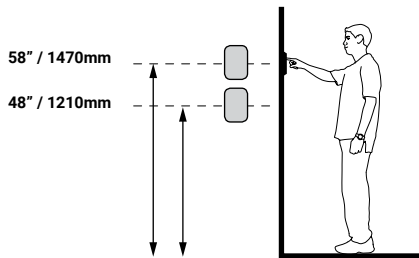

System Diagram:

This diagram shows the main components and topology of the WaveLinx system with LITE devices. The WaveLinx LITE devices use standardized IEEE 802.15.1 (Bluetooth® 4.2 Low Energy) mesh technology for device communications without the requirement of a gateway. The WaveLinx LITE enabled luminaires provide out-of-the-box functionality for independent operation when energized. With the use of the WaveLinx LITE mobile application with MyApps secure cloud portal access, groups of independent luminaires may be created and maintained with areas, control zones, and occupancy sets. WaveLinx LITE devices are not currently compatible with the WaveLinx Area Controller.

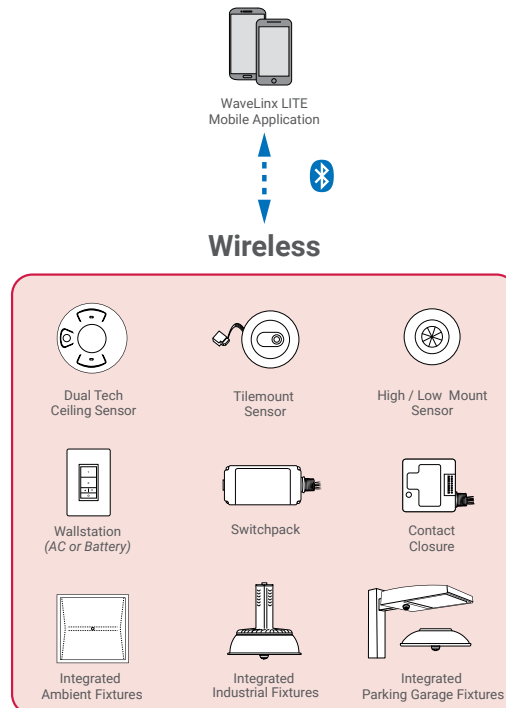

Control Systems
• WaveLinx



Cooper Lighting Solutions has developed recommended guidelines for cleaning our products that will not impact the operation or finish of the product.

Recommended cleaning tips:

- **Never spray any fluids directly into the device.**
- **Use of ammonia-based or VOC cleaners on this device must be avoided.** Prolonged use may cause loss of integrity and expose electrified components. If this occurs, turn OFF power to the unit and replace.
- **Use a damp rag or single-use wipe** to avoid excess liquid penetrating the device.
- Be sure to wipe up remaining excess liquid after cleaning.
- Ensure the cleaning agent used does not have harsh chemicals such as bleach, ammonia, highly alkaline or concentrated acids (such as hydrochloric acid that can be found in household cleaners such as toilet bowl cleaners, bathroom tile and porcelain cleaners) as they could damage the device, causing them to become brittle and discolored.
- Cooper Lighting Solutions recommends the use of a mild liquid detergent and water to clean the devices. Single use wipes (e.g. Lysol brand or equivalent) are acceptable to use for cleaning the devices, however the single-use wipes **cannot contain bleach, ammonia, highly alkaline or concentrated acids.**

Recommended cleaning instructions:

- **Never spray any fluids directly into the device.**
- Apply the mild liquid detergent to a damp cloth or paper towel. Single use wipes (e.g. Lysol brand or equivalent) are acceptable to use for cleaning the devices, however single-use wipes cannot contain bleach, ammonia, highly alkaline or concentrated acids.
- If excess liquid is present, remove by wringing out the cloth or paper towel to avoid liquid penetration into the device.
- Clean the Cooper Lighting Solutions device by wiping over the surface with the damp cloth.
- Remove an excess liquid remaining on the device with a dry cloth or paper towel.

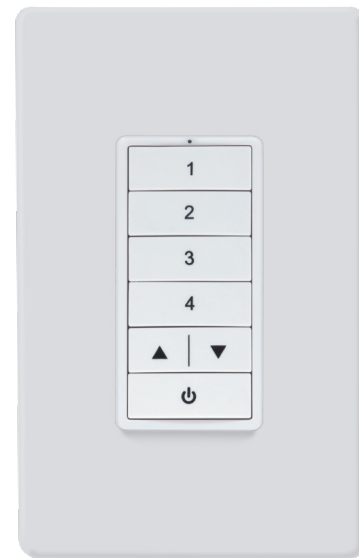

image for reference only

⚠ WARNING

This product is not intended for use in applications involving the use of ammonia-based or VOC cleaners.

Prolonged use may cause loss of integrity and expose electrified components.

If this occurs, turn OFF power to the unit and replace.