

Project		Catalog #		Type	
Prepared by		Notes		Date	



Metalux

SK-12, SK-14, SK-22, SK-24

2x2, 2x4, 1x4, and 1x2 Surface Mount Kits
Field Install Version

Typical Applications

Plenum-less spaces. • Retrofits • Remodel projects

Interactive Menu

- Product Specifications [page 2](#)
- Dimensional Details [page 2](#)
- Mounting Details [page 3](#)
- Compatibility Matrix [page 4](#)
- Product Warranty

Product Certification



Product Features



Top Product Features

- The Metalux universal field install surface mount kits allow for numerous recessed fixture families from Cooper Lighting Solution's to be installed in plenum-less spaces
- Ideal for retrofits, remodel projects, or where a recessed fixture is preferred but plenum space is not available
- Works with 2' x 2', 2' x 4', 1' x 4' and 1' x 2' Metalux, Fail-Safe and Corelite product series
- See Compatibility Matrix (page 4) and Ordering Information below for specific availability
- Options to meet Build America, Buy America and Buy American domestic preference requirements

Order Information

Stock or MTO	Size	Catalog Number	Description
Stock	2' x 4'	SK-24-WT	2' x 4' Surface Mount Kit, Tall
Stock	2' x 2'	SK-22-WT	2' x 2' Surface Mount Kit, Tall
Stock	1' x 4'	SK-14-WT*	1' x 4' Surface Mount Kit, Tall
Stock	1' x 2'	SK-12-WT	1' x 2' Surface Mount Kit, Tall

NOTES: The weight of the installed luminaire (ONLY) not to exceed 40 lbs.
Flex cables sold separately.
Review Compatibility Matrix before placing order for recessed luminaire.
*SkyRidge 1' x 4' fixture with curved reflector ("C") does not fit the 1' x 4' kit without requirement for special bracket, please submit PDR request for order processing.

Product Specifications

Construction

- Feature snap-together frame design constructed of dieformed cold rolled steel
- 2' x 2', 2' x 4', 1' x 4' and 1' x 2' are only offered in a Tall ((6-5/8" or 6-9/16") version to accommodate any fixture type and options
- Composite end caps provide simple snap on attachment to housing for a finished look
- Additional safety #10 screws can be used if necessary at pre-tap locations
- Four access plate knockouts provide flexible installation and supply connection
- A set of four mounting points are provided for surface mounting, for pendant mount six mounting points are provided for either two or four point suspension
- Cooper Lighting Solutions SCA (1/2" O.D.) suspension sets (#SCA-48-B) are recommended for stem mounting

Finish

- Durable cold rolled steel housing is finished in high reflectance white using electrostatically applied polyester powder coat paint to ensure maximum rust inhibition
- End caps provide matching matte white finish.

BABA Domestic Preference Compliance

- This Cooper product is manufactured in the US and meets the BABA cost of components rule. To verify a configured product with specific accessories and options meets BABA Domestic Preference Requirements; submit this catalog number to Cooper Lighting Quotation team for validation by our Engineering and Manufacturing teams. Our BABA designation is based on the minimum compliance requirement for BABA. Individual Government Agencies may have more stringent compliance standards. Please refer to the [DOMESTIC PREFERENCES](#) website or consult the CLS Domestic Preferences team for more information. Components shipped separately may be separately analyzed under domestic preference requirements.

Mounting

- Both versions are designed to provide a means for surface or pendant mounting

Limited Warranty

- One year limited warranty

Dimensional Details

Inside

		SK-24-WT	SK-22-WT
A	Width	24"	24"
B	Length	48-1/16"	24-1/16"
C	Height	6-3/8"	6-3/8"

Outside

		SK-24-WT	SK-22-WT
D	Width	24-1/4"	24-1/4"
E	Length	49-1/2"	25-1/2"
F	Height	6-5/8"	6-5/8"

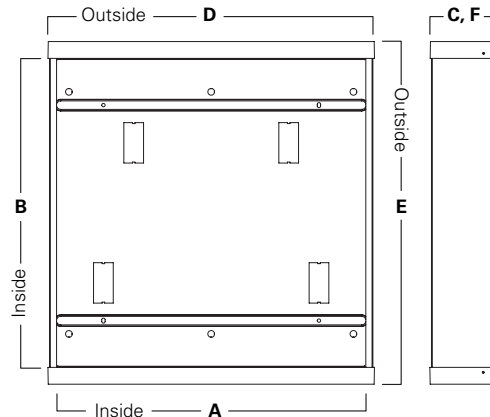

Inside

		SK-14-WT	SK-12-WT
A	Width	12"	12"
B	Length	48-1/16"	24-1/16"
C	Height	6-1/4"	6-1/4"

Outside

		SK-14-WT	SK-12-WT
A	Width	12-3/16"	12-3/16"
B	Length	49-7/16"	25-7/16"
C	Height	6-9/16"	6-9/16"

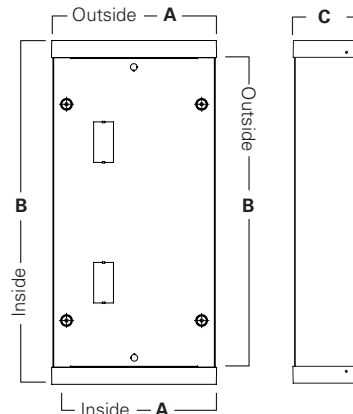

Shipping Data

Catalog No.	Wt.
SK-22-WT	14 lbs.
SK-24-WT	24 lbs.
SK-14-WT	13 lbs.
SK-12-WT	7 lbs.



Mounting Details

Hole Mounting

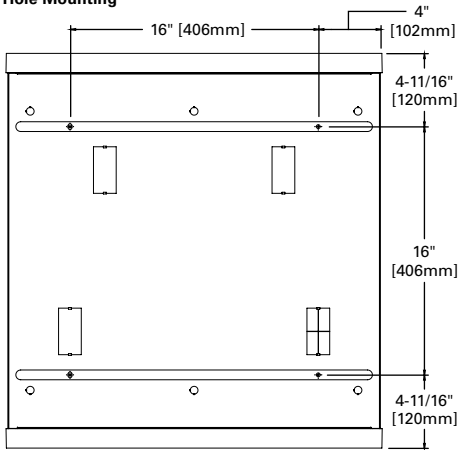

Hole Mounting

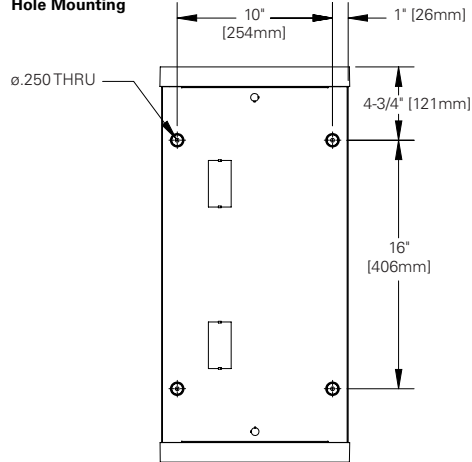

Pendant Mounting

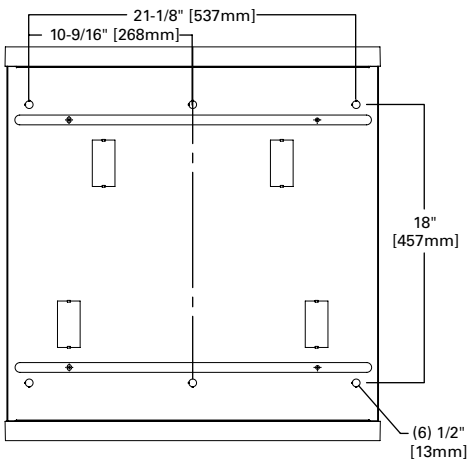

Pendant Mounting

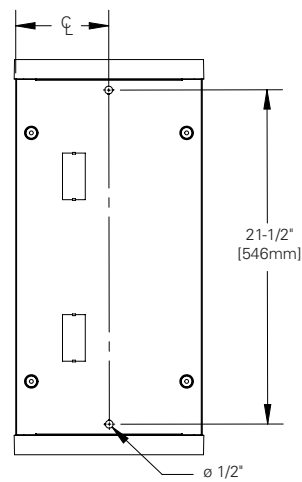



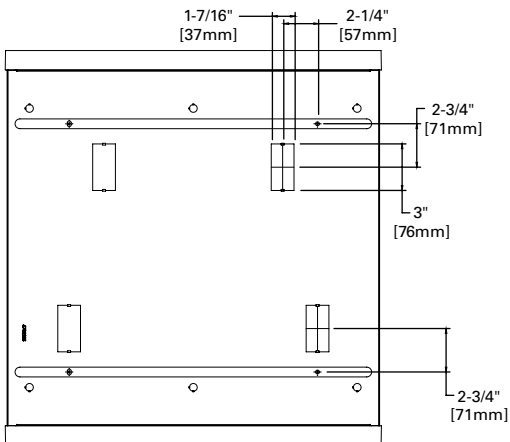



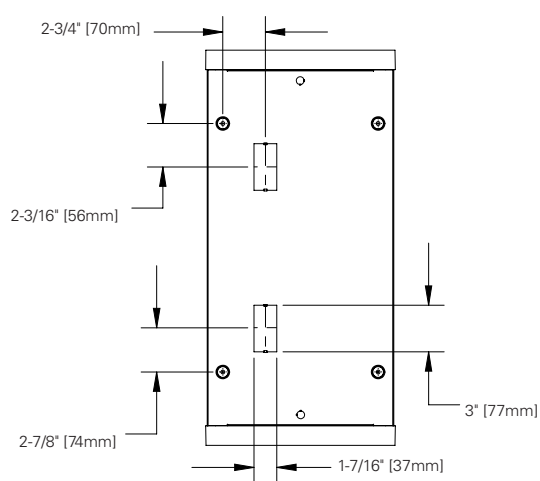











Access Plate Location



Access Plate Location



Compatibility Matrix LED Fluorescent

	Tall Design			
	2' x 2'	2' x 4'	1' x 4'	1' x 2'
	SK-22-WT	SK-24-WT	SK-14-WT	SK-12-WT
Metalux				
Accord				
Cruze SB				
GR 1x4			 	
Ovation				
Parabolics ⁽³⁾				
RLN 1x4				
SkyRidge ⁽¹⁾				
Fail-Safe⁽²⁾				
GRV				
GRW				
Corelite				
InDepth				
Perceive PD 1x4				

Notes: (1) SkyRidge 1' x 4' fixture with curved reflector ("-C-") does not fit the 1' x 4' kit without requirement for special bracket, please submit PDR request for order processing.

(2) Fail-Safe fixtures with emergency do not fit either kit size.

(3) Covers 2EP3 only