

DESCRIPTION

Roundback lampholders. Available in white or black finish. White lampholder available with white baffle. Uniform deep plug box allows line voltage and low voltage (L4019) fixtures to blend together in an installation. For use with Halo and Lazer-by-Halo track systems.

Catalog #	Type
Project	
Comments	
Prepared by	Date

SPECIFICATION FEATURES

A...Electrical Quick Lock Adapter/Transformer

Polycarbonate casing. Attaches electrically and mechanically anywhere along Power-Trac. Visual polarity line assures proper grounding. Two position conductor allows use in single circuit and either circuit of two circuit track.

B...Yoke

Yoke allows lampholder to rotate horizontally 358° for maximum aiming adjustability.

C... Lampholder Housing

Roundback style housing with black Coilex baffle.

D... Lampholder Housing

Roundback style housing with black Coilex baffle.

Listings

UL listed and CSA certified for use with Halo and Lazer-by-Halo track and track systems.

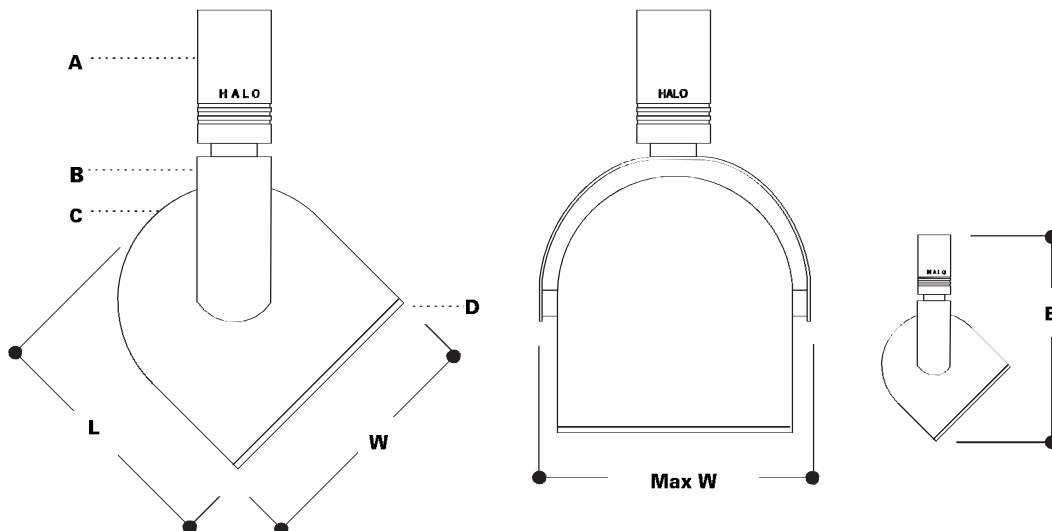

L4010



L4011



L4012

ORDERING INFORMATION

SAMPLE NUMBER: L4010P

Lampholders	Finishes	Accessories
<p>L4010 L4011 L4012</p>	<p>P=Satin White with Black Baffle MB=Matte Black with Black Baffle P/W=White with White Baffle</p>	<p>(See Below)</p>

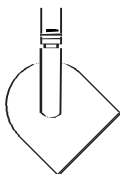
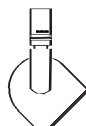
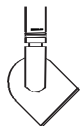

L4010

For use with:
50W PAR20,
75W PAR16
L = 4 1/4" [108mm]
W=3 1/2" [89mm]
Max W=4 5/8" [119mm]
E = 7 1/2" [191mm]

Accessories

L1971 Barn Doors

L4011

For use with:
75W PAR30
L = 4 1/2" [114mm]
W=4 3/8" [111mm]
Max W=5 1/2" [140mm]
E = 7 3/4" [197mm]

Accessories

L1972 Barn Doors
(Barn Door allows use of filters and lenses)
L200 Series Filters/lenses
L275 Louver

L4012

For use with:
150W PAR38
L = 6 3/4" [171mm]
W=5 7/8" [149mm]
Max W=5 1/2" [140mm]
E = 10" [254mm]

Accessories

L1964 Barn Doors
(Barn Door allows use of filters and lenses)
L314 UV Filter
L300 Series Filters
L277 Louver

**COLETTO ROUND BACK
CYLINDERS WITH BLACK
BAFFLE**

Power-Trac®

ADV042250
Supersedes ADV990310

ACCESSORIES

Barn Door Shutters

L1964=Barn Door Shutters for L4012. Barn door is designed to clamp onto lampholder. Barn Door Shutter allows use of filters and Louvers

L1971=Barn Door Shutters for L4010. Barn door is designed to clamp onto lampholder. Barn Door Shutter allows use of filters and Louvers.

L1972=Barn Door Shutters for L4011. Barn door is designed to clamp onto lampholder.

Color Code: MB

Color Code: MB

Color Code: MB

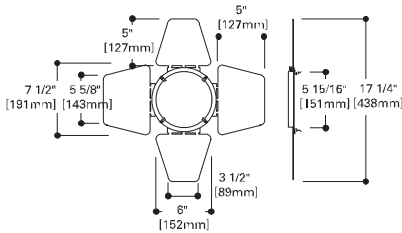

L1964

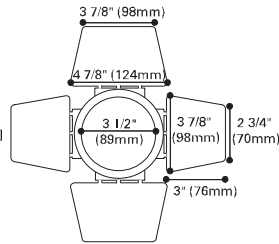

L1971

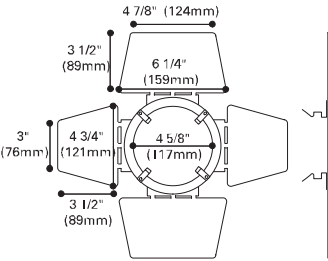

L1972



L1964 Barn Doors

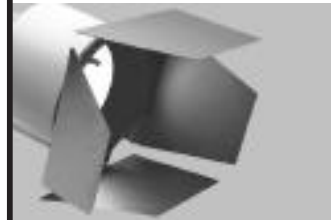

L1971,72 Barn Doors

L200 Series Color and UV Filters

4 11/16" (110mm)

Provides either a soft or intense hue to accent a lighting installation.

- L211=Medium Pink
- L221=Medium Blue
- L214=Ultraviolet Filter
- L241=Medium Green
- L220=Daylight Blue

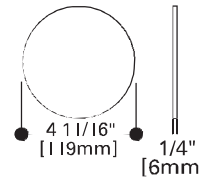

L200 Color Filters

L300 Series Color and UV Filters

6 5/16" (160mm)

Can be used with L4012 lampholder when L1964 Barn door shutters are used. Provides either a soft or intense hue to accent a lighting situation.

- L312=Warm Red Color Filter
- L314=Ultraviolet Filter
- L320=Daylight Blue Color Filter
- L330=Straw Color filter
- L311=Medium Amber Color Filter
- L341=Medium Green Color Filter

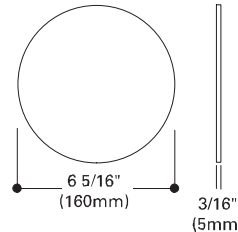

L300 Color Filters

L200 Series Optical Lenses

L1961 Barn Door Shutters required to hold lenses.

L210=Linear Spread Lens

L210 lens fans out light beam 55° - 27 1/2° each side of center

L215=Radial Spread Lens

L215 lens spreads light beam 30° in all directions - 15° on all sides of center

L250=Linear Spread Lens

L250 lens spreads light beam in one direction

L265=Prismatic Spread Lens

L265 Spreads light beam in all directions

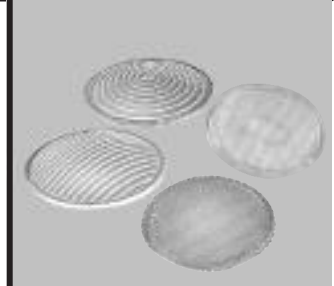
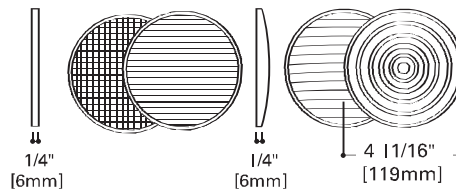

L200 Optical Lenses

L275 Cube Cell Louver

4 3/4" OD (121mm). Black finish 1/2" cells for directing light and eliminating glare. Requires barn doors.

L277 Cube Cell Louver

6 1/4" OD (159mm). Black finish 1/2" cells for directing light and eliminating glare. Requires barn doors.

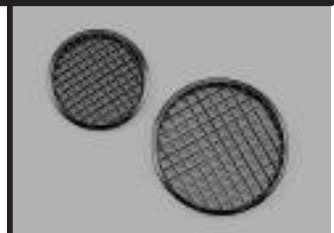
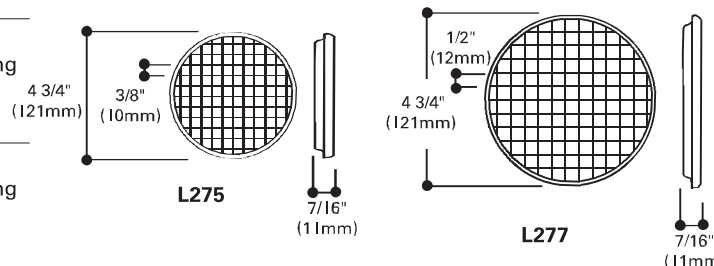

Cube Louvers