

Project		Catalog #		Type	
Prepared by		Notes		Date	

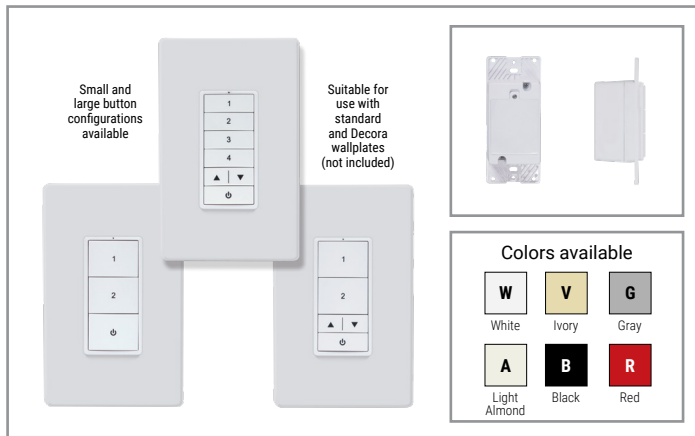

## WaveLinX

### LITE Battery-Powered Wallstation (WWBL-Series) and colored wallstations (WST series)

Multi-scene, single area dimming battery powered wallstation which provides customized light level for each area

#### Typical Applications

Office • Education • Hospitality • Retail • Industrial • Manufacturing

#### Interactive Menu

- Order Information page 2
- Button Options page 2
- Additional Resources page 3
- Connected Systems page 4
- Product Warranty



- Meets latest ASHRAE Standard 90.1 requirements
- Meets latest IECC requirements
- Meets latest CEC Title 24 requirements

#### Product Features



#### Compatibility



## Overview

The LITE Battery-Powered Wallstation is an integral part of the WaveLinX LITE system and is available in small and large button configurations. The wallstation, powered by two CR123A batteries, is a multi-scene/dimming device which allow users to control the lights within an area/room. The wallstation communicates with the other LITE devices within the area using Bluetooth® 4.2 Low Energy standard.

The wallstation mounts in a standard wallbox (single or multi-gang) suitable for use with standard wallplates (not included). Each wallstation is fully configurable to provide local control in each area. Each button is configured to control a lighting scene for an area and can be modified using the WaveLinX LITE application.

Wallstation models provide default sequence of operations including 50% light level, scene light levels between 30-70% as well as 100% and full off. Two wallstation configurations also include raise/lower buttons to manually adjust the light levels.

## Product Features & Benefits

- Multi-scene selection, raise/lower, off for an area
- Suitable for standard single or multi-gang NEMA wall box
- Utilizes two (2) CR123A alkaline batteries for simple new or retrofit installations
- Battery life expectancy up to five years
- Clean, elegant and simple control
- 5 Color options available
- Configurable through software - no physical adjustments
- WaveLinX LITE is DLC Listed for interior applications - meeting the NLC5 Technical Requirements Energy calculations available through WaveLinX CORE

## Order Information

WaveLinx LITE Wallstations are accessories to the WaveLinx LITE system which may be commissioned via the WaveLinx LITE mobile application.

WaveLinx LITE devices are not currently compatible with the WaveLinx Area Controller.

SAMPLE ORDER NUMBER: **WST-L-3D-R-BP** (WaveLinx LITE 3 Button Dimming, Red, Battery Powered)

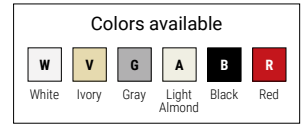

Catalog Number

## Standard Wallstation Configurations - White

Catalog Number	Description
<b>WWBL3-W</b>	WaveLinx LITE Battery-Powered Wallstation, 3 Button, White
<b>WWBL3-RL-W</b>	WaveLinx LITE Battery-Powered Wallstation, 3 Button Raise / Lower, White
<b>WWBL5-RL-W</b>	WaveLinx LITE Battery-Powered Wallstation, 5 Button Raise / Lower, White
<b>Notes</b>	<b>Notes</b>
WaveLinx LITE application required to customize programming for each button.	Suitable for use with standard and Decora wallplates (not included). Complete wallstation - buttons are not field replaceable.

## Custom Engraved Wallstation Configurations - White

Catalog Number	Description
<b>WWBL3-W-ENGRV</b>	WaveLinx LITE Battery-Powered Wallstation, 3 Button, White, Custom Engraved
<b>WWBL3-RL-W-ENGRV</b>	WaveLinx LITE Battery-Powered Wallstation, 3 Button Raise / Lower, White, Custom Engraved
<b>WWBL5-RL-W-ENGRV</b>	WaveLinx LITE Battery-Powered Wallstation, 5 Button Raise / Lower, White, Custom Engraved
<b>Notes</b>	<b>Notes</b>
WaveLinx LITE application required to customize programming for each button.	Suitable for use with standard and Decora wallplates (not included). For custom engraving use the configurator tool within the FlashPro Program (CUST-ENGRV). Complete wallstation - buttons are not field replaceable.

## Colored Wallstation Configurations

Product	System Type	Button Configuration	Color	Power Supply	Custom Engraving
<b>WST = Wallstation</b>	<b>L = LITE</b>	<b>3</b> = 3 Button <b>3D</b> = 3 Button Dimming <b>5D</b> = 5 Button Dimming	<b>V</b> = Ivory <b>G</b> = Gray <b>A</b> = Light Almond <b>B</b> = Black <b>R</b> = Red	<b>BP</b> = Battery Powered	<b>ENGRV</b> = Custom Engraved
<b>Notes</b>					<b>Notes</b>
WaveLinx LITE application required to customize programming for each button. Suitable for use with standard and Decora wallplates (not included). Buttons are not field replaceable.					For configuring Custom Engraved wall stations, please use <a href="#">Configurable Spec. Sheet</a> .

## Additional Accessories

Wallplates are not included with Wallstations. Please order separately.

Catalog Number

Catalog Number	Description
<b>PJS26W</b>	1 Gang Screwless Faceplate, White
<b>PJS262W</b>	2 Gang Screwless Faceplate, White
<b>PJS263W</b>	3 Gang Screwless Faceplate, White
<b>PJS264W</b>	4 Gang Screwless Faceplate, White
<b>PJS265W</b>	5 Gang Screwless Faceplate, White

## Required Accessories

Download and register the WaveLinx LITE mobile application from either the Google Play or Apple Store. This mobile application can be used to form a lighting network - creating control zones, occupancy sets, setting occupancy or vacancy modes of operation, configuring daylighting, etc.



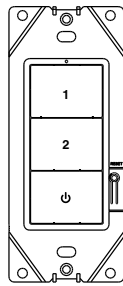

WWBL3-W

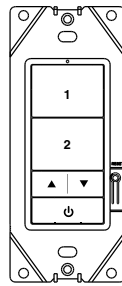

WWBL3-RL-W

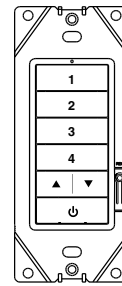

WWBL5-RL-W

Standard button engraving for each wallstation

### Default engraving & light levels

<b>Button 1</b>	Scene 3 = 50%
<b>Button 2</b>	Scene 1 = 100%
<b>Button 3</b>	Scene 2 = 70%
<b>Button 4</b>	Scene 4 = 30%
<b>Raise press*</b>	Increase 1% (per press)
<b>hold*</b>	Increase 15% (per sec)
<b>Lower press*</b>	Decrease 1% (per press)
<b>hold*</b>	Decrease 15% (per sec)
<b>Power*</b>	Scene 0 = OFF

\* - affects all zones in area

### Raise / Lower / OFF buttons

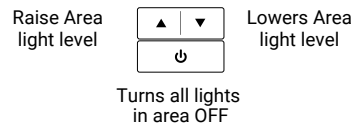

### Button programming options via WaveLinx Lite Mobile Application

- Scene Selection
- Zone Level
- Raise Level
- Lower Level
- No Action

## Product Specifications

### Mechanical

**Size:** 4.2"H x 1.8"W x 1.5"D (107mm x 45mm x 39mm)

### Environment:

- **Operating temperature:** 32°F to 113°F (0°C to 45°C)
- **Storage temperature:** 32°F to 167°F (0°C to 75°C)
- **Relative humidity operating:** 5% to 95% non-condensing
- For indoor use only

**Mounting:** Standard decorator opening (wallplate not included)

**Colors:** White, Ivory, Gray, Light Almond, Black and Red

### Electrical

**Power supply type:** Utilizes two (2) CR123A alkaline batteries (included)

### Hardware Specifications

#### Status Indicators:

- Single indicator LED
- LED functionality (active for 3 seconds after action)
  - Indication of wireless network join request
  - Indication of wireless network connection
  - Scene indication of operations

#### Button Configuration:

- 3 Button
- 3 Button with Raise / Lower
- 5 Button with Raise / Lower

### Software Specifications

- Each button programmable to trigger Scene or Zone
- Default values when joined to a network (area) via WaveLinx LITE application
- Models available with dominant button 50% light level
- Secure firmware upgrade OTA from mobile application

### Wireless Specifications

**Radio:** 2.4GHz

**Standard:** IEEE 802.15.1 - Bluetooth® 4.2 Low Energy (BLE)

**Transmitter Power:** +7dBm

**Range:** Device to device; 100ft (30m) LOS (best practice)

Note - metal wallplates will reduce wireless range

### System Performance

**Maximum number of nodes supported:** Best practice of 40 devices, maximum of 50 devices per commissioned network

### Standards/Ratings\*

- FCC Part 15, Subpart B & C
- Meets latest ASHRAE Standard 90.1 requirements
- Meets latest IECC requirements
- Meets latest CEC Title 24 requirements
- NEMA WD-7 and NEMA 4 compliant
- CA Title 20 and Prop 65 compliant
- RoHS
- WaveLinx LITE is DLC Listed for interior applications - meeting the NLC5 Technical Requirements

### Warning

- This product is not intended to be used in applications involving the use of ammonia-based or VOC cleaners.
- Use of ammonia-based or VOC cleaners on this device must be avoided. Prolonged use may cause loss of integrity and expose electrified components. If this occurs, turn OFF power to the unit and replace.
- For detailed cleaning guidelines please refer to: Controls Care and Maintenance instructions at the end of this document.

### Warranty

Five year warranty standard



Download the WaveLinx LITE Mobile App from either the Google Play or Apple Store

## Dimensional Details

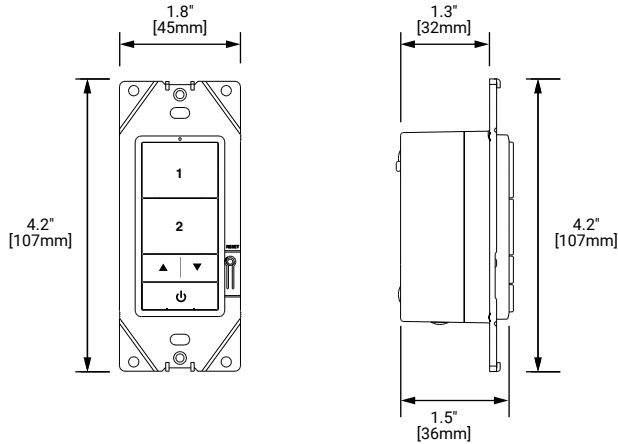

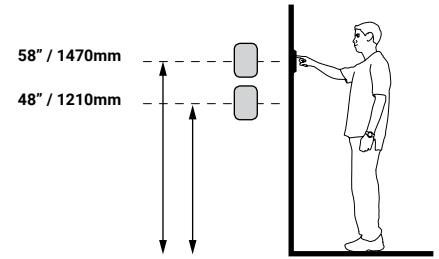

## Mounting Height

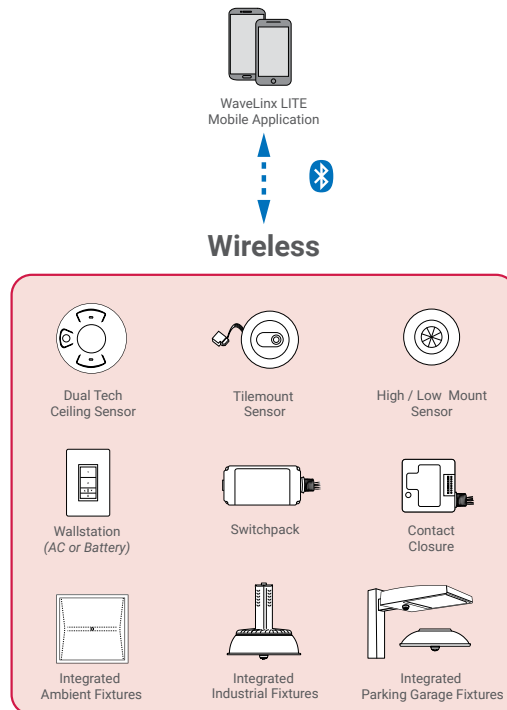

## System Diagram:

This diagram shows the main components and topology of the WaveLinx system with LITE devices. The WaveLinx LITE devices use standardized IEEE 802.15.1 (Bluetooth® 4.2 Low Energy) mesh technology for device to device communications without the requirement of a gateway. The WaveLinx LITE enabled luminaires provide out-of-the-box functionality for independent operation when energized. With the use of the WaveLinx LITE mobile application with MyApps secure cloud portal access, groups of independent luminaires may be created and maintained with areas, control zones, and occupancy sets. WaveLinx LITE devices are not currently compatible with the WaveLinx Area Controller.



 **Control Systems**  
• WaveLinx



Cooper Lighting Solutions has developed recommended guidelines for cleaning our products that will not impact the operation or finish of the product.

### Recommended cleaning tips:

- **Never spray any fluids directly into the device.**
- **Use of ammonia-based or VOC cleaners on this device must be avoided.** Prolonged use may cause loss of integrity and expose electrified components. If this occurs, turn OFF power to the unit and replace.
- **Use a damp rag or single-use wipe** to avoid excess liquid penetrating the device.
- Be sure to wipe up remaining excess liquid after cleaning.
- Ensure the cleaning agent used does not have harsh chemicals such as bleach, ammonia, highly alkaline or concentrated acids (such as hydrochloric acid that can be found in household cleaners such as toilet bowl cleaners, bathroom tile and porcelain cleaners) as they could damage the device, causing them to become brittle and discolored.
- Cooper Lighting Solutions recommends the use of a mild liquid detergent and water to clean the devices. Single use wipes (e.g. Lysol brand or equivalent) are acceptable to use for cleaning the devices, however the single-use wipes **cannot contain bleach, ammonia, highly alkaline or concentrated acids.**

### Recommended cleaning instructions:

- **Never spray any fluids directly into the device.**
- Apply the mild liquid detergent to a damp cloth or paper towel. Single use wipes (e.g. Lysol brand or equivalent) are acceptable to use for cleaning the devices, however single-use wipes cannot contain bleach, ammonia, highly alkaline or concentrated acids.
- If excess liquid is present, remove by wringing out the cloth or paper towel to avoid liquid penetration into the device.
- Clean the Cooper Lighting Solutions device by wiping over the surface with the damp cloth.
- Remove an excess liquid remaining on the device with a dry cloth or paper towel.

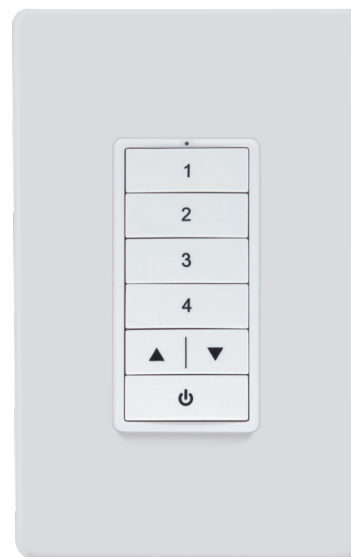

image for reference only

### **WARNING**

*This product is not intended for use in applications involving the use of ammonia-based or VOC cleaners.*

*Prolonged use may cause loss of integrity and expose electrified components.*

*If this occurs, turn OFF power to the unit and replace.*