

Project		Catalog #		Type	
Prepared by		Notes		Date	

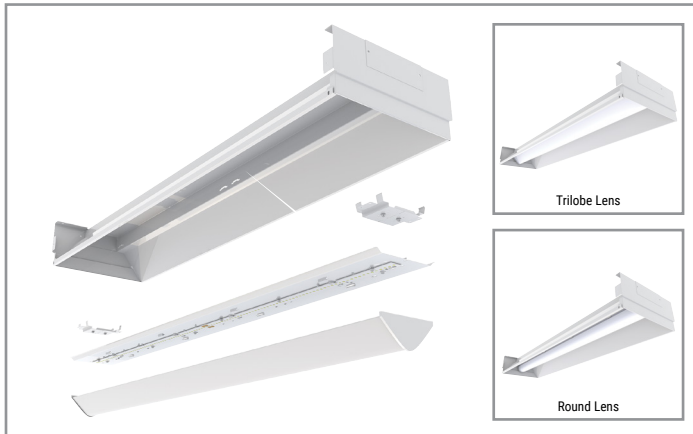

Metalux

Recessed Strip Retrofit Kit

Retrofit for Cooper RCC, RCG and similar products from other manufacturers

Typical Applications
Office • Education • Retail

Product Certification



Product Features



Interactive Menu

- Order Information [page 2](#)
- Photometric Data [page 3](#)
- Product Warranty

Top Product Features

- 4', 6' and 8' options with integrated LED and driver combined
- Simple and quick installation = labor savings
- Single 8' acrylic lens (round or trilobe) provides high efficiency
- High performance efficacy up to 168 lumens per watt
- Up to 8800 lumens (4') and 17500 lumens (8')
- Options to meet Trade Agreements Act requirements

Dimensional and Mounting Details

TRILOBE LENS OPTION

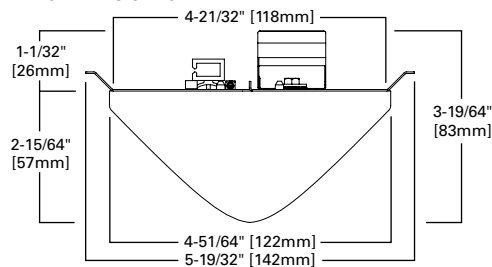

ROUND LENS OPTION

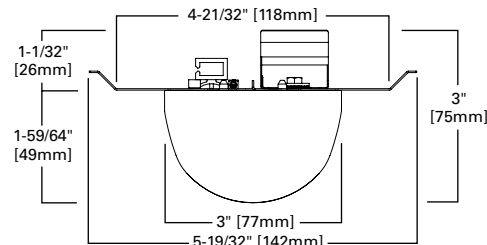

[additional product diagrams](#)

Order Information – Order Gear Tray and Lens separately

GEAR TRAY SAMPLE NUMBER: **8-RSRK-100-HE-L840-U**

Domestic Preferences ⁽¹⁴⁾	Length ^{(1), (2)}	Series ⁽¹¹⁾	Lumen Package ⁽⁴⁾	Efficacy	Voltage	Emergency Options
[Blank] =Standard TAA =Trade Agreements Act	4 =4' 6 =6' ⁽¹³⁾ 8 =8'	RSRK =Recessed Gear Tray	(total based on length at 500, 650, 1000, 1500 and 2000 Lumens per foot, 80 CRI and 3500K) 50 =500 Lms/ft 65 =650 Lms/ft 100 =1000 Lms/ft 150 =1500 Lms/ft 200 =2000 Lms/ft ⁽⁶⁾	HE =High Efficacy	[Blank] =Universal Voltage (120-277) 347 =347 Volt ^{(7), (9)} 120 =120Volt 277 =277 Volt	[Blank] =None EL7W =7-watt, 120V-277V emergency battery pack installed EL14W =14-watt 120V-277V emergency battery pack installed
Notes (14) Only product configurations with this designated prefix are built to be compliant with the Trade Agreements Act of 1979 (TAA). Please refer to DOMESTIC PREFERENCES website for more information. Components shipped separately may be separately analyzed under domestic preference requirements.	Notes (1) 8' fixtures wired with two 4' gear trays as a master satellite. (2) 6' not available with 90 CRI. (13) 6ft not available with EM or Sensors.	Notes (11) DesignLights Consortium® Qualified and classified for DLC Premium when used in the Metalux RCG and RCC products. Other manufacturer listings in progress. Refer to www.designlights.org for details.	Notes (4) For alternate lumen requirements PDR is required. Specify by lumens per foot in PDR request. Lumens are approximate. (6) Two drivers required for 2000 Lms/ft. 6' and 8'.		Notes (7) Not available with sensor or battery pack and not available in 2000 LPE. (9) Two drivers required for 347V versions for 6' and 8' at 1500 LPF and for 8' at 1000LPF.	

CRI/CCT	Driver Type	Number of Drivers	Circuits ⁽⁸⁾	Integrated Sensing Systems	Packaging
L830 =80CRI, 3000K L835 =80CRI, 3500K L840 =80CRI, 4000K L850 =80CRI, 5000K	[Blank] =0-10V Dimming Driver (1% Dimming) SD =Step Dimming Driver (50% or 100% Dimming) ⁽¹⁰⁾ SR =Sensor-ready Dimming Driver for LWIPD1 option (1%-100% Dimming) ⁽¹⁰⁾	[Blank] =1 driver per unit (8' has 2 gear trays with Master-Satellite arrangement) 2 =2 (one per gear tray, 8' unit only) ^{(8), (9), (9)}	P11BLK-WG-6PP =Single circuit with ground round Plug-In wiring harness. Black, white and green wires P12BLK-WG-6PP = Two circuit with ground round Plug-In wiring harness. Black, white, blue and green wires P13BLK-WG-6PP =Three circuit with ground round Plug-In wiring harness. Black, white, blue, red and green wires. P110V =Two pole dimming harness with purple and gray dimming control wires	[Blank] =None SWPD1 =WaveLinX Wireless Integrated Sensor ⁽⁴⁾ LWIPD1 =Enlighted Wireless Integrated Sensor ^{(8), (12)} SVPD1 =0-10V Stand-alone Integrated Sensor ^(C)	[Blank] =Unit Carton Gear Tray
	Notes (10) 6', 8' at 1500 LPF and 6' at 2000 LPF requires two drivers.	Notes (3) When using 2 drivers the driver type must be specified as HCD or SD. (6) Two drivers required for 2000 Lms/ft. 6' and 8'. (9) Two drivers required for 347V versions for 6' and 8' at 1500 LPF and for 8' at 1000 LPF.	Notes (8) Numerous wiring options available. Consult factory for special wiring applications.	Notes (12) LWIPD not available with lumen packages that require 2 drivers, 8ft 150HE and 200HE. Integrated options must be used in conjunction with the associated system and may not be compatible with other options or accessories. Please refer to the following: (A) Consult WaveLinX system pages for additional details and compatibility. (B) Consult Enlighted system pages for additional details and compatibility. (C) Consult SVPD series system pages for additional details and compatibility.	

LENS SAMPLE NUMBER: **8-TB**

Lens Length	Lens Type	Packaging	Accessories (order separately) ⁽¹⁵⁾
8 =8 foot full length 6 =6 foot full length ⁽⁷⁾ 4 =4 foot full length 8ES =8 foot EM or sensor length 4ES =4 foot EM or sensor length	TS =Trilobe Smooth (Wide Distribution) TB =Trilobe Ribbed (Wide distribution) RM =Round Ribbed (Medium Distribution)	[Blank] =Bulk (6 packs) and/or Unit at plant discretion ⁽⁵⁾	RSRKPB =RSRK Parts bag with two mounting brackets and mounting hardware
Notes (7) Not available with sensor or battery pack and not available in 2000 LPF.		Notes (5) Lenses will be shipped as bulk and unit packs based on the order received.	Notes (15) Accessories sold separately will be separately analyzed under domestic preference requirements. Consult factory for further information.

Product Specifications

Construction

- Kit consists of three primary components: mounting brackets, gear tray with LED boards, driver and optional lenses (shipped separately)
- Mounting brackets provided with features to align gear trays for straight row alignment
- Kits come pre-assembled with quick connects
- Gear tray is painted after fabrication

Electrical

- TM21 life at 60,000 hours up to L94 and calculated L70 exceeds 295,000 hrs.
- LEDs available in 3000K, 3500K, 4000K, and 5000K with CRI > 80
- Available in 120-277V and 347V
- 0-10V 1% dimming standard

Emergency Battery Options

- Optional 120-277V integral battery pack available in 7W or 14W
- Test switch/indicator can be tested safely from the ground using laser pointer
- EZ Key prevents accidental discharge during construction

Optics

- Three optical distributions available with frosted acrylic to hide the LEDs
- Trilobe smooth lens provides wide distribution
- Trilobe ribbed lens provides a wide distribution and higher efficacy
- Round Ribbed lens provides a medium distribution and the highest efficacy

Compliance

- cULus listed for the RCG
- Rated for damp locations and RCC. UL Classified for others.
- Tested in compliance with IESNA LM79
- LEDs are tested in compliance with IESNA LM80
- Can be used for State of California Title 24 non-residential high efficacy luminaires
- DesignLights Consortium® Qualified and classified for DLC Premium, refer to www.designlights.org for details.

Warranty

- Five-year warranty

Photometric Data

[View IES files](#)

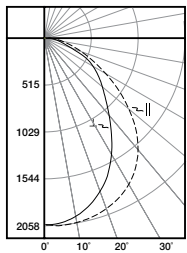

Gear Tray: 4-RSRK-100-HE-L840 Lens: 4-RM

Dimming Driver
 Linear LED 4000K
 Spacing criterion: (||) 1.3 x mounting height,
 (⊥) 1.05 x mounting height
 Lumens: 4351
 Input Watts: 28.8W
 Efficacy: 151.1 LPW
 Test Report: 4RSRK-RM-100-HEL840.IES

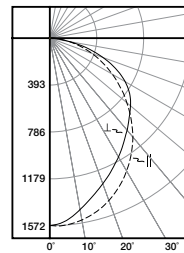

Gear Tray: 4-RSRK-100-HE-L840 Lens: 4-TB

Dimming Driver
 Linear LED 4000K
 Spacing criterion: (||) 1.21 x mounting height,
 (⊥) 1.09 x mounting height
 Lumens: 4098
 Input Watts: 28.8W
 Efficacy: 142.3 LPW
 Test Report: 4RSRK-TB-100-HEL840.IES

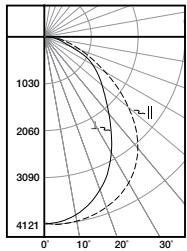

Gear Tray: 8-RSRK-100-HE-L840 Lens: 8-RM

Dimming Driver
 Linear LED 4000K
 Spacing criterion: (||) 1.3 x mounting height,
 (⊥) 1.05 x mounting height
 Lumens: 8702
 Input Watts: 57.6W
 Efficacy: 151.1 LPW
 Test Report: 8RSRK-RM-100-HEL840.IES

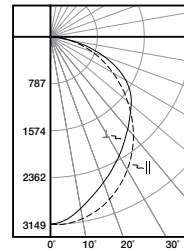

Gear Tray: 8-RSRK-100-HE-L840 Lens: 8-TB

Dimming Driver
 Linear LED 4000K
 Spacing criterion: (||) 1.21 x mounting height,
 (⊥) 1.09 x mounting height
 Lumens: 8196
 Input Watts: 57.6W
 Efficacy: 142.3 LPW
 Test Report: 8RSRK-TB-100-HEL840.IES

Energy and Performance Data by Catalog Numbers

Catalog Logic	Fixture Total Length	Watts with standard 0-10V driver	No Lens Performance		TB - Trilobe Ribbed Lens Performance		TS - Trilobe Smooth Lens Performance		RM - Round Ribbed (Medium)	
			Delivered Lumens @ 80 CRI, 4000K	Efficacy (LPW)	Delivered Lumens @ 80 CRI, 4000K	Efficacy (LPW)	Delivered Lumens @ 80 CRI, 4000K	Efficacy (LPW)	Delivered Lumens @ 80 CRI, 4000K	Efficacy (LPW)
4-RSRK-50-HE-L840-U	4'	15.5	2308	159.1	2064	142.3	1955	134.8	2192	141.4
4-RSRK-65-HE-L840-U	4'	18.9	2994	158.4	2678	141.7	2536	134.2	2844	150.5
4-RSRK-100-HE-L840-U	4'	28.8	4577	158.9	4094	142.2	3877	134.6	4347	151.0
4-RSRK-150-HE-L840-U	4'	44.2	6737	152.4	6026	136.3	5707	129.1	6399	144.8
4-RSRK-200-HE-L840-U	4'	61.2	8881	145.1	7944	129.8	7523	122.9	8436	137.8
6-RSRK-50-HE-L840-U	6'	20.9	3461	165.6	3096	148.1	2932	140.3	3288	157.3
6-RSRK-65-HE-L840-U	6'	27.8	4491	161.5	4017	144.5	3804	136.8	4266	153.4
6-RSRK-100-HE-L840-U	6'	43.1	6866	159.3	6141	142.5	5816	134.9	6521	151.3
6-RSRK-150-HE-L840-U	6'	64	10106	157.9	9039	141.2	8560	133.7	9599	150.0
6-RSRK-200-HE-L840-U	6'	95.1	13322	140.1	11916	125.3	11284	118.7	12654	133.1
8-RSRK-50-HE-L840-U	8'	27.5	4615	167.8	4128.0	150.1	3909	142.2	4384	159.4
8-RSRK-65-HE-L840-U	8'	36.8	5988	162.7	5356.0	145.5	5072	137.8	5688	154.6
8-RSRK-100-HE-L840-U	8'	55.7	9154	164.3	8188.0	147.0	7754	139.2	8695	156.1
8-RSRK-150-HE-L840-U	8'	85.7	13474	157.2	12052.0	140.6	11413	133.2	12798	149.3
8-RSRK-200-HE-L840-U	8'	122.4	17763	145.1	15888.0	129.8	15046	122.9	16871	137.8

Lumen Calculator

CCT Multiplier	80 CRI Multiplier
3000K	0.967
3500K	0.983
4000K	1.00
5000K	1.00

Load Data

	4'	6'	8'
PF	> .9		
THD%	< 20%		
Low Temp Start	-20° C		
Weight	3.3	4.4	9.8

Example of Lumen Adjustment Calculation

Gear Tray= 8-RSRK-100-HE-L840-U
 @ 80CRI at 3500K
 Lumen Adjustment Factor = 0.983
 Total Light Output =
 $8,188 \text{ lm} \times 0.826 = 8,049 \text{ lm}$
 $\text{Efficacy} = \frac{8,049 \text{ lm}}{57.6 \text{ W}} = 140 \text{ lm/W}$

Shipping Data

Gear Tray Catalog No.	Units per pallet (53" x 30")	Wt.	Lens Catalog No.	Units per pallet	Wt.	Pallet Size
4RSRK	30	6 lbs.	4-TB	32 Bulk packs (192 units)	288 lbs.	49" x 52"
6RSRK	30	7.5 lbs.	6-TB	144 Unit packs	324 lbs.	48" x 100"
8RSRK	30	9 lbs.	8-TB	32 Bulk packs (192 units)	576 lbs.	48" x 100"

Trilobe Lens Mounting Data

4' TRILOBE LENS OPTION

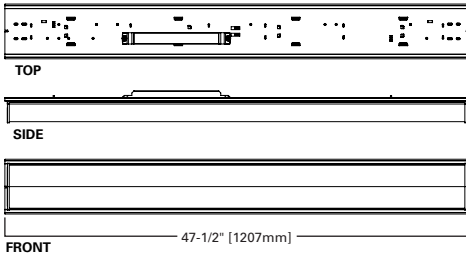

6' TRILOBE LENS OPTION

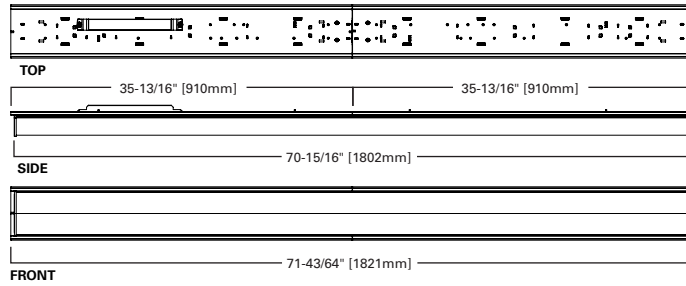

8' TRILOBE LENS OPTION

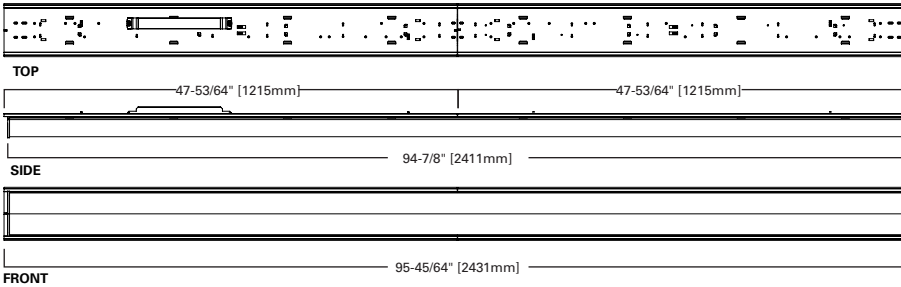

Round Lens Mounting Data

4' ROUND LENS OPTION

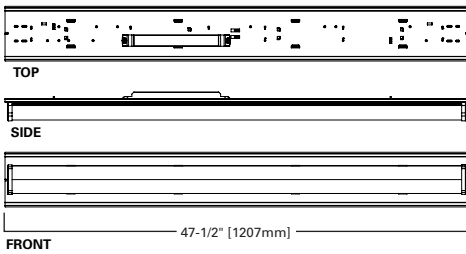

6' ROUND LENS OPTION

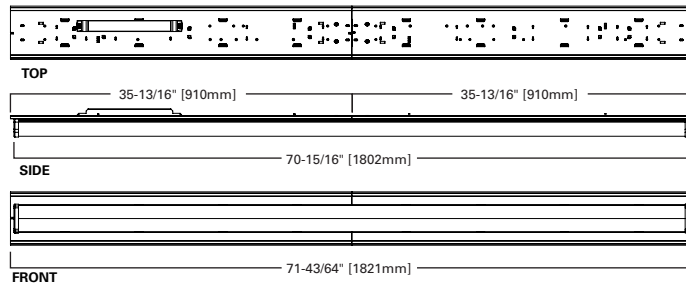

8' ROUND LENS OPTION

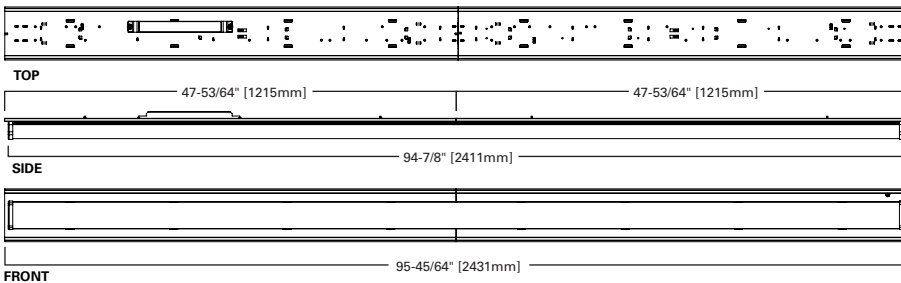

END BRACKET FOR ALL VERSIONS

